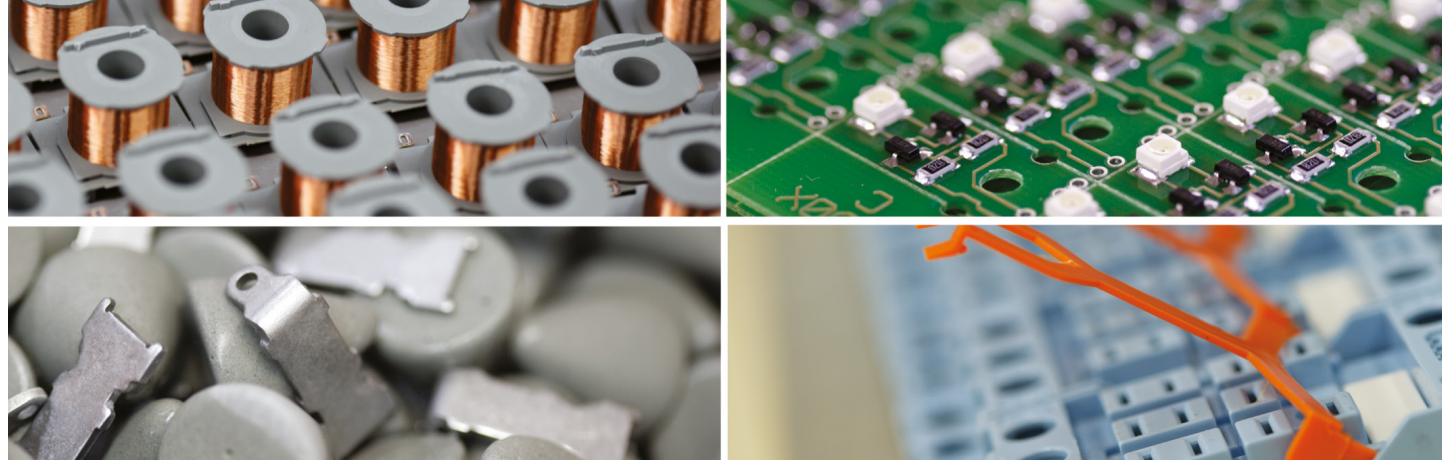


WORLD OF RELAYS

Catalogue

WoR 1



ComatReleco at a glance

ComatReleco is one of the world's leading suppliers of high-quality relays and contactors of all kinds. With one of the broadest product portfolios, including customized solutions, ComatReleco serves customers in the industrial automation and building installation, rail and transportation segments. Our core competencies are industrial relays, timing relays, monitoring relays and contactors. These are installed with the latest semiconductor technologies or also with the traditional electromechanical design.

Designed in Switzerland, assembled in...

ComatReleco continuously invests in research and development, thus ensuring a consistently high rate of innovation. Several international patent applications support this fact. Our research and development team is headquartered in Switzerland and has access to additional qualified employees in our subsidiaries in Germany and China. With a share of more than 20% of total research and development costs, we outperform many global players in our segment.

Customer orientation and quality management

ComatReleco has a group-wide quality management system with real-time access to test and inspection protocols. Our relays and contactors are 100% tested at the end of the production line. On arrival of the goods at our central warehouse in Switzerland, another quality test is carried out.

Are you using a ComatReleco product or are you looking for a suitable solution? Our support centre in Switzerland will be happy to help you find the right relay or contactor for your application. ComatReleco is known for the world's largest number of customized solutions for industrial, time and monitoring relays and contactors.

Headquarters in Switzerland – international presence

The warehouse and logistics are managed centrally at the headquarters in Switzerland. Production is diversified and optimized in terms of quality, costs and logistics criteria. Our production sites are located in Europe and Asia. Through our network of distribution partners, the Group is present on all world markets. ComatReleco has been part of the management team since 2003.

Index

1 Relays & Contactors			Page 7
1.1	Interface Relays - pluggable	C10, C12, C16, C18	15
1.2	Interface Relays	CRINT, CINT, CHA	25
1.3	Industrial Relays - pluggable	C2, C3, C4, C5, C7, R7, C9	33
1.4	Extended Lifetime Relays	C2x, C3x	67
1.5	Solid State Relays	CSS, CRINT	73
1.6	Installation Relays	CHI, C100/200/300, CR, B	81
1.7	Installation Contactors	RIC, RAC, RBC	93
1.8	Industrial Contactors	RMC, RSC	113
1.9	Solid State Contactors	CC1, CC3, CPC	131
2 Time Relays			Page 147
2.1	ON and OFF delay Relays	CMD, AA2, AE2	151
2.2	Multifunction Time Relays	CIM, AL, AM, CM, CPF, CRV, CSV	157
2.3	Star-Delta Relays	CY1	183
2.4	Time Relays - pluggable	C, CS, RS	185
2.5	Timers & Twilight Switches	CPU, QSU, EDS	197
2.6	Time Cubes	CT2, CT3	203
2.7	Time Modules	CT	207
2.8	Timing Relay Accessories	ACESSORIES	213
3 Monitoring & Measuring Devices			Page 223
3.1	Energy Measuring Device	MRE	225
3.2	Multifunction Monitoring	MRM	229
3.3	Voltage Monitoring	MRU, MV, SSU	233
3.4	Voltage Monitoring - pluggable	SSU	239
3.5	Current Monitoring	MRI	243
3.6	Motor Protection - pluggable	TSR	247
3.7	Isolation Monitoring	ESU	249
3.8	Monitoring Modules	CT	251
3.9	Suppressor Device	CEM, CRC	255
3.10	Current Transmitter	MRE-CT	259
3.11	Monitoring Relay Accessories	ACESSORIES	265
4 Sockets			Page 269
4.1	8-Pin Sockets	S2	273
4.2	11-Pin Sockets	EC-11, S3, S5	277
4.3	14-Pin Sockets	S4	287
4.4	8/14-Pin Sockets	S7, S9	291
4.5	5/8-Pin Sockets	S10, S12, S16, S18	297
5 Remote Monitoring & Control			Page 305
5.1	ComatReleco Messaging System (SMS Relay)	CMS	307
5.2	CMS Accessories	ACESSORIES	311
6 Softstarter			Page 325
6.1	Softstarter	CTC, CCL, CCM	327
6.2	DC Motor Controller	CMC, KDM3-24	343

1 Relays & Contactors

Type	Page	Type	Page
B103	92	CHI34	83
C2-A2x	36	CINT-51 / CINT-61	29
C3-A3x	37	CINT-52 / CINT-62	30
C3-G3x	39	CINT-53/ CINT-63	31
C3-M1x	40	CPC1230	141
C3-N3x	43	CPC1250	142
C3-R2x	42	CPC1430	143
C3-T3x	38	CPC1450	144
C3-X1x	41	CR11C	89
C4-A4x	44	CR16CX	90
C4-R3x	46	CRINT 1x1 series	27
C4-X2x	45	CRINT 1x2 series	28
C5-A2x	47	CRINT 1x5 series	78
C5-A3x	48	CRINT 1x8 series	79
C5-G3x	49	CRS1C	91
C5-M1x	51	CSS-I	74
C5-M2x	52	CSS-N	76
C5-R2x	53	CSS-P	77
C5-X1x	50	CSS-Z	75
C7-A1x	54	R7-A2x	61
C7-A2x	55	R7-T2x	62
C7-G2x	57	RAC20	101
C7-H2x	58	RAC25	102
C7-T2x	56	RAC40	103
C7-W1x	60	RAC63	104
C7-X1x	59	RBC-AUX	108
C9-A4x	63	RBC-AUX-CM	109
C9-E2x	64	RBC-AUX-GM	110
C9-R2x	65	RBC20	105
C10-A1x	16	RBC32	106
C10-G1x	17	RIC-AUX	107
C10-T1x	18	RIC-DIST	111
C12-A2x	19	RIC-SEAL	112
C12-G2x	20	RIC16	94
C16-A25PTL	21	RIC20	95
C18-A15PT	22	RIC20-xxx-R4A110V	96
C18-A15PTL	23	RIC25	97
C18-B15PTL	24	RIC32	98
C21	68	RIC40	99
C22	69	RIC63	100
C31	70	RMC-AUX	125
C32	71	RMC-DI	129
C133.01	84	RMC-RC	127
C203.01	85	RMC08	114
C203.04	86	RMC11	115
C203.06	87	RSC-AUX	126
C301.04	88	RSC-MBL	130
CC1H215	132	RSC-MP	124
CC1H230	133	RSC-RC	128
CC1H250	134	RSC09	116
CC1H415	135	RSC12	117
CC1H430	136	RSC16	118
CC1H450	137	RSC22	119
CC3H410	138	RSC30	120
CC3H420	139	RSC38	121
CCR3H410	140	RSC43	122
CHA1	32	RSC63	123
CHI14	82		

2 Time Relays

Type	Page
AA2, AA2M	154
AE2, AE2M	155
AL1	170
AL3	171
AL4	172
AL5	173
AM1	174
AM2	175
AM3	176
BZS DIN 17.5 mm	215
C55	186
C55.3	187
C55.4	188
C56	189
C64	190
C83	191
C85	192
CIM1, CIM1R	160
CIM2, CIM2R	164
CIM3, CIM3R	167
CIM12, CIM12R	161
CIM13, CIM13R	162
CIM14	163
CIM22, CIM22R	165
CIM23, CIM23R	166
CIM32, CIM32R	168
CIM33, CIM33R	169
CM2	177
CM3	178
CMD11-A	152
CMD11-E	153
CPF11	179
CPU	198
CRV4	180
CS2	193
CS3	194
CSV4	181
CT2	204
CT3	205
CT32R	209
CT33R	210
CT36R	211
CY1	184
EDS17	200
EDS35	201
FA-50	219
FS-C	221
FZ-50L	220
HF-32	216
HF-33	217
HF-50	218
QSU	199
RS 41-M	195
SP-01	214

3 Monitoring & Measuring Devices

Type	Page
CEM01	256
CRC02	257
CT515R	252
CT524	253
ESU-D2R	250
FS-23	267
FZ-23	266
HF-24	268
MRE-44S	227
MRE-CT313	260
MRE-CT314	261
MRE-CT614	262
MRE-CT1233	263
MRI11	244
MRI32	245
MRM11, MRM11R	230
MRM32, MRM32R	231
MRU11	234
MRU32	235
MV53	236
SSU31	240
SSU33L	241
SSU34	237
TSR19	248

4 Sockets

Type	Page
EC-11	280
S2-B	274
S2-PO	275
S3-B	278
S3-M	281
S3-M0 / S3-M1	282
S3-S	279
S4-J	288
S4-P	289
S5-M	283
S5-P	284
S5-SSY	285
S7-C	292
S7-IO	293
S7-P	294
S9-M	295
S9-P	296
S10	297
S10-P	299
S12	300
S12-P	301
S16-M	302
S18-M	303

5 Remote Monitoring & Control

Type	Page
CMS-10F	308
CMS-10ADF	309
CMS-10ACDF	310
CMS-ANT-KAB	314
CMS-ANT-MAG/2.5M	313
CMS-ANT-SPEZ/5M	312
CMS-RS232	315
CMS-USB	316
DR-15-24, DR-30-24	317
KS-110	322
MV-LKM-274	318
PS1	323
RF01-U, RF01-U-D2	319
RTBSB-001-010	320
WF50-EXT-U4	321

6 Softstarter

Type	Page
CCL33H415US	330
CCL33H425US	331
CCL33H435US	332
CCM33H425US	337
CCM33H450US	338
CCM33H530USi	339
CCM33H550USi	340
CCM3H403USi	333
CCM3H415	334
CCM3H415DS	335
CCM3H425	336
CCMB3H425	341
CMC1	344
CMC14	345
CMC15	346
CMC16	347
CTC3415	328
CTC3425	329
KDM3-24	348
P82-100C	342

7 Worldwide Sales Network

Country	Page
Argentina	352
Australia	350
Austria	351
Belgium	351
Bolivia	352
Bosnia and Herzegovina	351
Brazil	352
Bulgaria	351
Canada	352
Chile	352
China	350
Colombia	352
Croatia	351
Czech Republic	351
Denmark	351
Ecuador	352
Estonia	351
Finland	351
Germany	351
Great Britain	351
Greece	351
Hungary	351
India	350
Iran	350
Ireland	351
Italy	351
Korea	350
Latvia	351
Lithuania	351
Malaysia	350
Mexico	352
Netherlands	351
New Zealand	350
Nigeria	351
Norway	351
Pakistan	350
Peru	352
Poland	351
Republic of Macedonia	351
Russia	351
Serbia	351
Singapore	350
Slovakia	351
Slovenia	351
Spain	351
Sweden	351
Switzerland	351
Taiwan	350
Thailand	350
Turkey	350
United States	352
Uruguay	352
Vietnam	350

Industrial Relays
General Information

Product range

ComatReleco offers a wide range of relay types and versions and associated sockets and accessories.

Industrial Relays C2, C3, C4, C5

35 x 35 mm round plug-in relay, 8- or 11-terminals multipole connector according to IEC 67 with 2 or 3 contacts up to 10 A and different contact types and contact materials. Standard relay 35 x 35 mm with flat blade connectors with up to 4 contacts and up to 16 A with 4 contacts.

Industrial Relays C7, C9

22.5 mm series with up to 4 contacts and up to 10 A with 1 or 2 contacts.

Interface Relays, C10, C12, C16, C18

Overall width 13 mm with up to 2 electro-mechanical contacts, or fully electronic switches.

Special relays, remanence relays

While "normal" relays are monostable, i.e. they return to the idle state when the excitation is switched off, remanence relays are bistable, i.e. the current switching state is retained irrespective of the excitation. Relays of this type are available in different versions.

Solid State Relay CSS

CSS Relays are suitable to either switch AC or DC loads up to 6 A. For AC relays a distinction is made between synchronously (zero crossing) and asynchronously switching versions. For switching transformer loads we recommended using asynchronously switching semiconductor switches. For incandescent lamp loads etc. synchronously switching switches are ideal for avoiding high switch-on currents.

Accessories

Suitable sockets are available for the different relay series for DIN rail mounting or panel mounting. In addition, retaining clips are available for the relays, some of which are included in the scope of supply. Suitable bridges for cost-saving wiring in series are also available.

(*) Special requirements

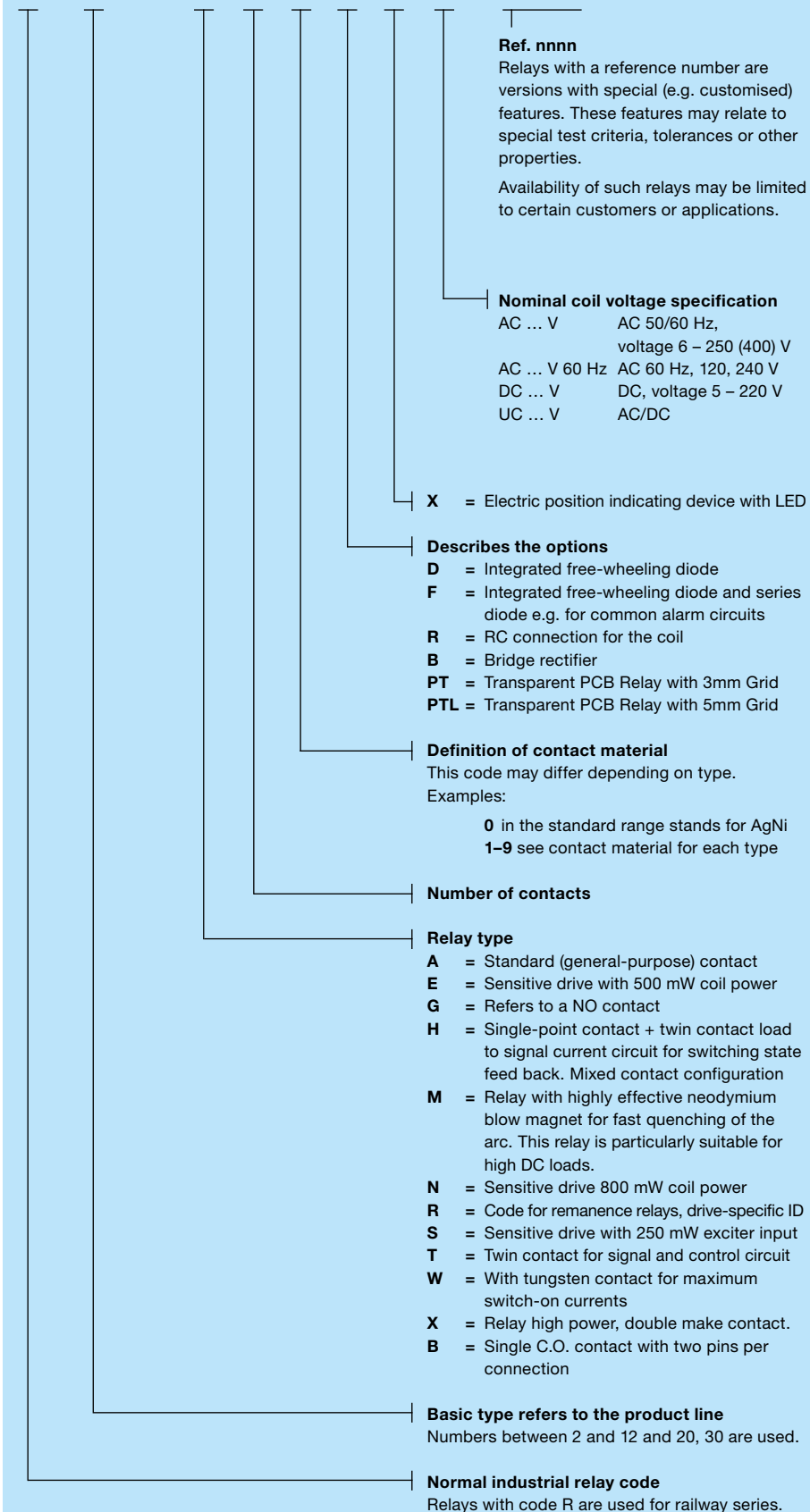
H = Orange button. No lockable function
N = Black button. No function
P = PCB pins

E = Lap transparent cover
T = Close transparent cover (lamp)

PT = PCB pins, 3.5mm grid, transparent cover
PTL = PCB pins, 5mm grid, transparent cover

Basic identification principle (type designation code electromechanical relays)

C **n(n)** - **T** **X** **y** **z(*)z** /...V **RF-nnnn**



Coil accessories
General Information

Industrial Relays C2-C9

Protection against transients

When the coil is disconnected from an electromagnet, peaks of inverse voltage appear at the terminals which can reach very high values. These pulses can be transmitted down the line associated with the coil and could possibly affect other components. In the case of a relay being operated by such devices as transistors, Triacs, etc; it may be necessary to protect against transients.

Transients carried in the line

High voltage surges can be carried in the supply line to the relay coil. These may appear in the form of peaks or bursts and are generated by the connection and disconnection of electric motors, transformers, capacitors etc. Normally a relay is unaffected by these pulses, but if a diode is connected in association with the coil, it must be capable of withstanding an inverse voltage higher than those of the incoming peaks.

Protection circuits

A protection circuit must efficiently cope with pulses generated by the coil as well as incoming line surges (surges $U_{1,250\mu s}$)
ComatReleco Relays are available with integrated protection circuits or with modules plugged into sockets S3-M, S3-M0 or S3-M1.

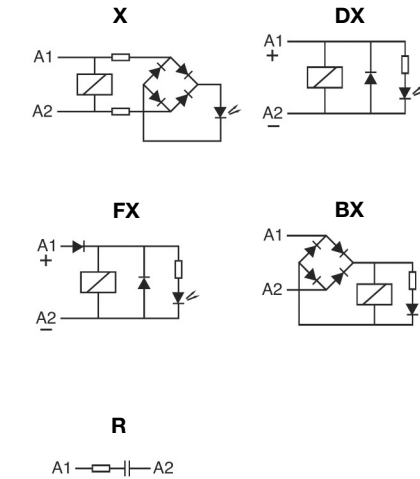
X LED indication with rectifier.
For DC and AC relays up to 250 V
Note: LED connected, in series with the coil @ 220 V DC in QRC types.

DX Free-wheeling diode + LED
Dampens transients caused by the relay coil on de-energisation.

FX Polarity + free wheeling diode + LED
A diode in series with the coil protects the relay from reverse connection.

BX Bridge rectifier + LED indication
Allows the relay to operate in both AC or DC without any polarity inconvenience. Available only in voltages up to 60 V.

R Resistor and capacitor.



Industrial Relays C10-C18

LED and protection circuit connected to coil.

- X** LED with no polarity, (standard)
Coils ≤ 12 V A DC coils
LED rectifier bridge in parallel
- X** LED with no polarity, (standard)
Coils ≥ 24 V A DC coils
LED rectifier bridge in series
- FX** LED with polarity **A1+** (option)
Every DC coil voltage
Polarity and Free-wheeling diodes
- BX** LED with no polarity, (option)
Only 24 V and 48 V A DC coils
Rectifier bridge for AC/DC relays
- R** LED not available (option)
RC protection against pulses on AC

Protection against pulses

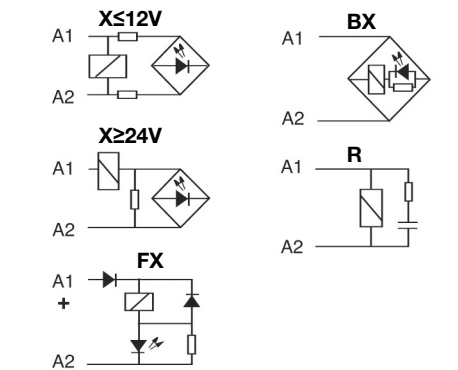
When a relay coil is disconnected, reverse voltage peaks may arise and reach very high values. Said peaks can transmit to the coil associated line and other relays or semiconductors can be affected.

If Triac, transistor, etc. controls a relay, appropriate steps must be taken to avoid or decrease peaks down to a non risky level.

Both Polarity and Free-wheeling diodes (**FX**), must protect coils, to avoid malfunctions provided DC relays in battery are installed.

Making or breaking engines, transformers or contactors in an industrial environment, may generate high voltage pulses, either isolated or burst, through the main line.

The voltage level of those pulse may be high enough to affect the isolation of the coil.



Industrial Relays

General Information

Contacts

There are different contact types. The main distinction is between single contacts and twin contacts. While single contacts are more suitable for higher loads, twin contacts are significantly more reliable at small loads, i.e. < 24V, < 100mA.

Contact Material

There is no all-purpose contact! AgNi is used as standard material for a wide range of applications. AgNi contacts with hard gold plating (up to 5µm) are offered for applications in aggressive atmosphere. Relays with gold contacts are approved for relatively high currents (e.g. 6A, 250V), but in practice values of 200mA, 30V should not be exceeded for operation with intact gold plating. Relays with a tungsten pre-contact are available for very high switch-on currents (up to 500A, 2.5ms). For some applications AgNi contacts with gold flashing (0.2µm) are available. The purpose is corrosion protection during storage. Tin oxide is specially appropriated for load with high-inrush current.

Minimum load

The minimum load value is a recommended value under normal conditions such as regular switching, no special ambient conditions, etc. Under these conditions reliable switching behaviour can be expected.

Contact resistance

Initial values of resistance of contact can vary with the use, load and others conditions. Typical values when the relay is new is about 50mΩ.

Contact spacing

Normally all contacts have an air gap between 0.5 ... 1.5mm when they are open. They are referred to as µ contacts. According to the Low-Voltage Directive and the associated standards these contacts are not suitable for safe disconnection. For switching of DC loads large contact clearances are beneficial for quenching the arc. See relays with "Cx-Gyz" naming. "G" stands for extended contact gap of 3mm.

Switching capacity

The contact switching capacity is the product of switching voltage and switching current. For AC the permitted switching capacity is generally high enough to handle the max. continuous AC-1 current over the whole voltage range. For DC the load limit curve must never be exceeded, because this would lead to a remaining switch-off arc and immediate destruction of the relay. The order of magnitude of the DC switching capacity is a few 100W (DC-1).

Drive (coil)

The drive of a relay refers to the coil plus connections.

The coil has special characteristics, depending on the rated voltage and the type of current.

Coil design

The coil consists of a plastic former (resistant up to about 130°C) and doubly insulated high-purity copper wire, temperature class F. The winding must withstand threshold voltages (EN 61000-4-5) of more than 2000V. This is ensured through forced separation of the start and end of the winding.

Coil resistance and other properties

Each coil has an ohmic coil resistance that can be verified with an ohmmeter. The specified coil resistance applies to a temperature of 20°C. The tolerance is ±10%.

For AC operation the coil current will not match the ohmic value, because self-inductance plays a dominant role. At 230V this may reach more than 90H. When a relay is switched off, self-inductance results in a self-induced voltage that may affect the switching source (destruction of transistors, EMC problems).

Drive voltages

A distinction is made between the standardised voltages according to EN 60947 as guaranteed values, and typical values that can be expected with a high degree of probability.

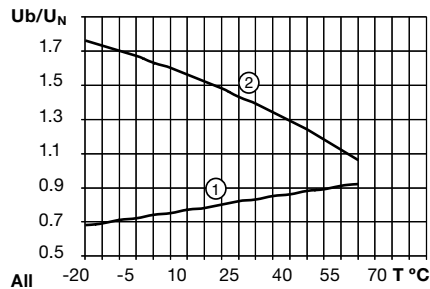
Pick-up voltage, Release voltage

The pick-up voltage is the voltage at which the relay engages safely. For DC the typical trip voltage is approx. 65% of Unom, for AC approx. 75%. The release voltage, on the other hand, is approx. 25% or 60% respectively. For DC these voltages are strongly temperature-dependent, according to the temperature coefficient of Cu. This is not the case for AC, where the inductive resistance is the controlling factor, which is practically constant over a wide temperature range. With AC, in a certain undervoltage range the relay may hum, and the armature may flutter. This voltage range must be avoided.

Operating voltage range

Unless specified otherwise, the following characteristic curve applies for the operating voltage range. The upper limit of the coil voltage is determined by self-heating and the ambient temperature. Self-heating through contacts under high load must not be underestimated. It may be higher than the power dissipation in the drive.

During intermittent operation significantly higher overvoltages temporary may occur for short periods. If in doubt please consult our specialists.



General design

ComatReleco Relays are made from high-quality, carefully selected materials. They comply with the latest environmental regulations such as RohS. Their meticulous design makes them particularly suitable for industrial applications and installation engineering.

They are particularly service-friendly through robust terminals, mechanical position indicating device a standard, manual operation, dynamic, permanent characteristics. Colour coding for manual operation as a function of the coil voltage is another useful feature. Further options such as different coil connections, free-wheeling diode, LED display, bridge rectifier for AC/DC drives etc., and short-term availability of special versions for practically any drive voltage up to DC 220V / AC 400V leave nothing to be desired. Apart from a few special versions, in general, ComatReleco industrial relays feature manual operation (push/pull) and a mechanical position indicating device.

For safety reasons, manual operation may be replaced with a black button, if required.

Coil connections

Different coil connections can be integrated in the relay as an option.

For DC a cost-effective free-wheeling diode is available. Please note that the stated release times are generally specified without the coil connection.

While an additional LED status indicator has practically no effect, a free-wheeling diode (D) will lead to an increase in release time by a factor 2 to 5, or 10ms to 30ms. For AC VDRs or RC elements may be used. In this case resonance effects may have to be considered. VDRs and common RC elements may increase release times by less than 5 ms.

Industrial Relays

General Information

Standards, conformities

All ComatReleco relays feature the CE mark to indicate that CE standards apply e.g. 2kV surge resistance according to EN 61000-4-5. A significant and not generally available characteristic is that the coils and in particular the connections are able to withstand the voltage spikes that may occur in practice. In addition, the relays feature various technical approvals depending on the respective relay code, and they comply with further standards and guidelines. The main technical approvals include cURus, CCC, Lloyd's Register, cULus and EAC. The associated information is provided in the data sheets.

Switching classes

EN 60947 defines different switching classes that specify the suitability of contacts for different load types.

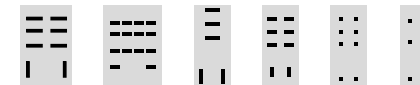
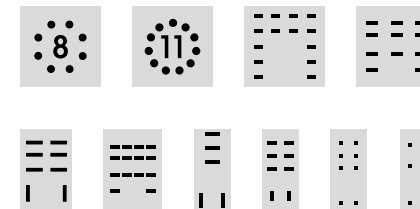
Example:

AC-1 = Ohmic AC load
AC-3 = Motor loads
AC-15 = Power contactors, solenoid valves, solenoids
DC-1 = Ohmic DC load
DC-13 = DC contactors, solenoids

UL60947 contains different technical approval criteria such as general purpose, control application etc. Switching classes are defined based on the electrical switching capacity, e.g. B600 etc.

Choosing the right Socket

For plug-in industry, interface, time, and monitoring relays, we offer sockets with the corresponding pin configuration and various layouts for the terminal connectors. For easy identification, you'll find those symbol referring to the matching socket.



Main technical approvals and standards

Country	Technical approval
China	Authority: CQC Specification GB14048.5-2001
Russia	Authority: KORPORATSIA STANDART Specification TP TC 004/2011
World Wide USA / Canada	Authority: UL Specification C 22.2; UL 60947
United Kingdom	Authority: GB Lloyd's Register of Shipping

Utilisation categories according to EN 60947-4-1/-5-1

Pollution category

Cat. 1

Dry, non-conductive contamination without further effect

Cat. 2

Occasional conductive contamination, short duration due to moisture condensation

Cat. 3

Dry, non-conductive and conductive contamination with moisture condensation

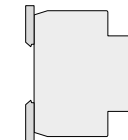
Cat. 4

Contamination with persistent conductivity through conductive dust, rain

Protection class IP according to EN 60529 and other standards. Industrial relays and their sockets can be classified as follows: Socket IP20: Contact safety Relay IP40/IP50: not watertight, but protected against ingress of coarse contaminants.

Electrical Distributor DIN 45mm

All devices with a housing fitting in an electrical distributor with a front of 45mm are marked with the following symbol.



Further information and tips

The main operational criteria for relays such as number of cycles, switching frequency, ambient conditions, reliability requirements, load type, switch-on current, load switch-off energy must be clarified in order to ensure reliable operation and long service life.

Example

If the number of cycles is expected to exceed several 100.000 operations per year (e.g. clock generators, fast running machines), an electronic solution is no doubt more appropriate, although we also offer solutions for this type of application. In AC applications crosstalk caused by long control leads is often a problem and can result in constant humming of the relay or even inadvertent triggering due to interference.

Different harmless loads may lead to very high switch-on currents or switch-off energy values, resulting in an unacceptable reduction in service life.

Particularly tricky are DC inductive loads.

Characteristics of various loads:

Heating circuits

No higher switch-on currents, no higher switch-off loads.

Incandescent lamps, halogen lamps

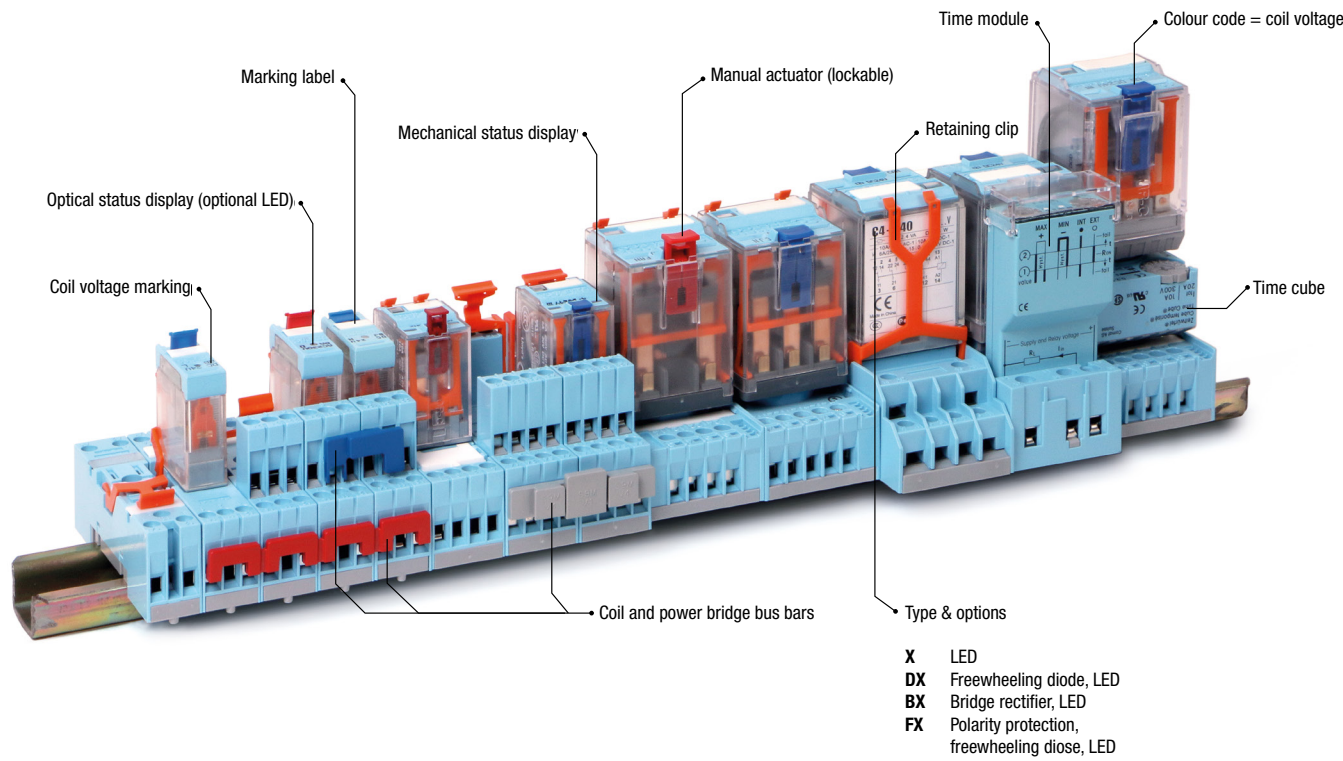
Switch-on currents during a few ms in the range 10 ... 18 x rated. Switch-off at rated load.

Low-energy lamps

Very high, but very short switch-on currents due to built-in decoupling capacitors. Contacts have a tendency to fuse.

Transformers, AC contactors

Switching on during zero-transition may lead to switch-on currents of 8 ... 15 x rated. High inductive switch-off energy is possible. The load must be connected, not least due to EMC problems.

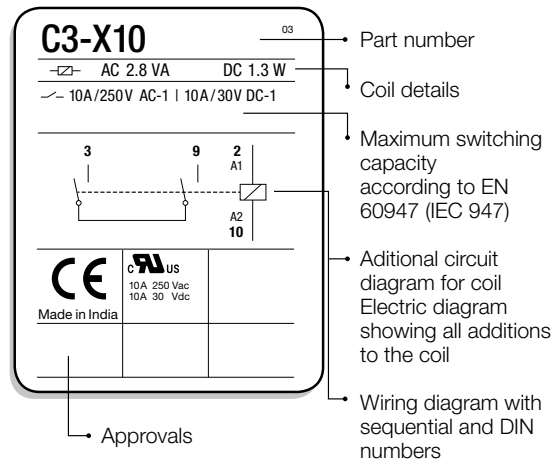


- X** LED
- DX** Freewheeling diode, LED
- BX** Bridge rectifier, LED
- FX** Polarity protection, freewheeling diode, LED

Five colours for an easier identification of coil voltage

- AC** red: 230 V AC (North America 120 V AC) If you don't want to have the lockable function, you can use the orange button.
- AC** dark red: others V AC
- Orange button, no lockable function, push only
- UC** grey: V AC/DC
- Black button, no function
- DC** blue: 24 V DC
- DC** dark blue: others V DC

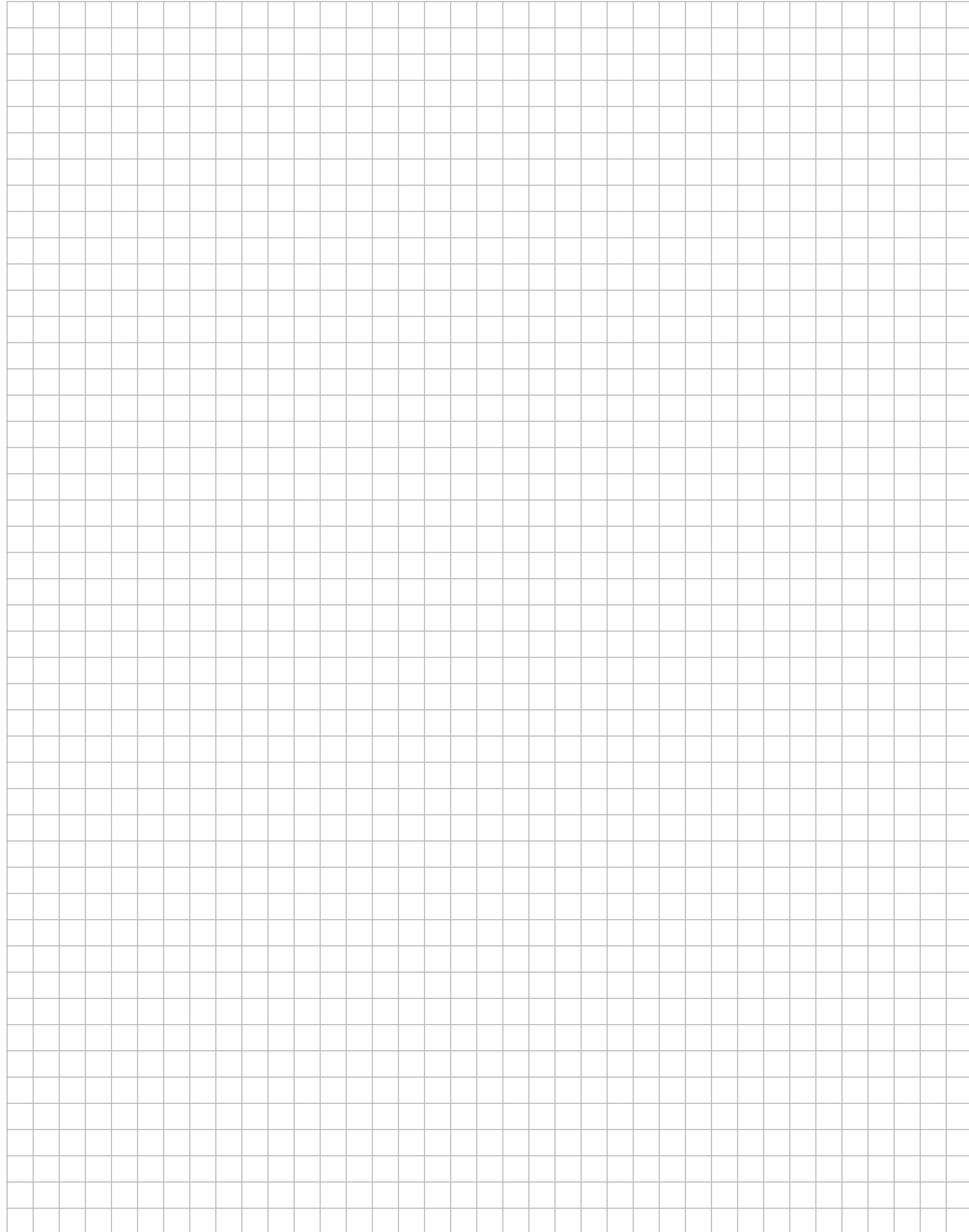
Comprehensive technical label












- Level of switching current and voltage of the application?
- DC or AC switching?
- Inductive or capacitive load?
- Expected number of switching cycles?

Symbol	Voltage	Current	Use	Type	Material	
Signal relays	100 mV...5V	10 uA...1 mA	Low-level signals, Standard signals (0...10V/4...20mA)	Gold-plated double contact	AgNi + Ag	
				Gold-plated Single Contact	AgNi + Ag	
Control relays	5V...30V	1 mA...100 mA	PLC inputs, Control circuits	double contact	AgNi	
				Gold-plated Single Contact	AgNi + Ag	
				Frequent, rapid switching procedures	Semiconductor	Mosfet (DC) Triac (AC)
Power relays	30V...400V	100 mA...16A	Increased AC or DC loads	Single Contact	AgNi	
				Electromagnets (utilisation cat. AC-15/DC-13)	Single Contact	AgSnO ₂
High-power relays	12V...400V	100 mA...16A	Capacitive loads	Early make contact	AgNi + W AgSnO ₂ + W	
				High DC loads, inductive loads	Series contacts	AgNi AgSnO ₂
				Frequent, rapid switching procedures, high reliability, noiseless switching	Semiconductor	Mosfet (DC) Triac (AC)

Notes



1.1 Interface Relays - pluggable

Application	Type	Pin	Page
C10 Series			
1 pole changeover contact Faston	C10-A1x		16
1 pole normally open contact Faston	C10-G1x		17
1 pole changeover twin contact Faston	C10-T1x		18
C12 Series			
2 pole changeover contact Faston	C12-A2x		19
2 pole normally open contact Faston	C12-G2x		20
C16 Series			
2 pole 8-pin changeover contact Grid 5mm	C16-A25PTL		21
C18 Series			
1 pole 5-pin changeover contact Grid 3.5mm	C18-A15PT		22
1 pole 5-pin changeover contact Grid 5mm	C18-A15PTL		23
1 pole 8-pin changeover contact Grid 5mm	C18-B15PTL		24

C10-A1x

1 pole | changeover contact | Faston

Maximum contact load	10 A/250 V AC-1	0.5 A/110 V DC-1
	10 A/30 V DC-1	0.2 A/220 V DC-1
Recommended minimum contact load	10 mA/10 V Code 0, 5	
	5 mA/5 V Code 8	

Contacts

Material	Standard	Code 0	⚡ AgNi
	Optional	Code 8	⚡ AgNi + 5 μ Au
	Optional	Code 5	⚡ AgSnO ₂
Rated Load	10 A		
Max. inrush current (20 ms)	30 A (120 A for code 5)		
Switching voltage max.	250 V		
AC load fig. 1	2.5 kVA		
DC load	see fig. 2		

Coil

Coil resistance	see table; tolerance ± 10 %
Pick-up voltage	≤ 0.8 x U _N
Release voltage	≥ 0.1 x U _N
Nominal power	1.1 VA (AC)/0.7 W (DC)

Coil table

V AC	Ω	mA	V DC	Ω	mA
24	290	45	12	224	53
48	1200	23	24	742	32
115	7.300	9.5	48	3.500	13.7
230	28.800	4.7	110	19.900	5.5

Insulation

Contact open	1000 V
Contact/coil	5 kV
Insulation resistance at 500 V	≥ 1 GΩ
Insulation, IEC 61810-1	4 kV

Specifications

Ambient temperature operation/storage	-40 ... 70 °C / -40 ... 80 °C (no ice)
Pick-up time/bounce time	10 ms / ≤ 1 ms
Release time/bounce time	5 ms / ≤ 3 ms
Mechanical life ops	AC: 10 Mill./DC: 20 Mill.
DC voltage endurance at rated load	≥ 100 000 switching cycles
Max. switching frequency at rated load	1200/h
Weight	21g

Product References

V AC 50 Hz/60 Hz: 24, 48, 115 (120), 230 (240)	C10-A10/AC...V	C10-A18/AC...V	C10-A15/AC...V
LED	C10-A10X/AC...V	C10-A18X/AC...V	C10-A15X/AC...V
RC Suppressor	C10-A10R/AC...V	C10-A18R/AC...V	C10-A15R/AC...V
V DC 12, 24, 48, 110	C10-A10/DC...V	C10-A18/DC...V	C10-A15/DC...V
LED	C10-A10X/DC...V	C10-A18X/DC...V	C10-A15X/DC...V
Polarity and free wheeling diode	C10-A10FX/DC...V	C10-A18FX/DC...V	C10-A15FX/DC...V
V AC/DC bridge rectifier 24 V, 48 V	C10-A10BX/UC...V	C10-A18BX/UC...V	C10-A15BX/UC...V
Other voltages on request			

"..." List Coil Voltage to complete Product References

Accessories

Socket	S10, S10-P
--------	------------



Connection diagram

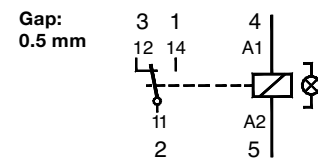


fig. 1 AC voltage endurance

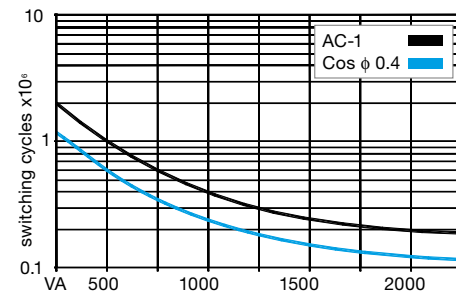
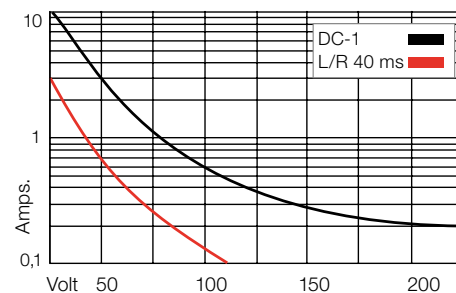
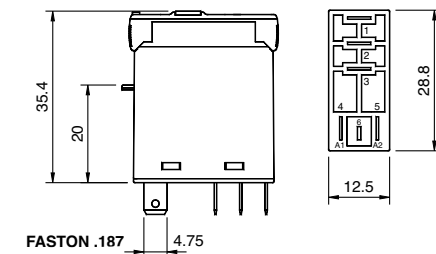


fig. 2 DC load limit curve



Dimensions (mm)



Technical approvals, conformities



C10-G1x

1 pole | normally open contact | Faston

Maximum contact load	10 A/250 V AC-1	0.8 A/110 V DC-1
	10 A/30 V DC-1	0.4 A/220 V DC-1
Recommended minimum contact load	10 mA/10 V Code 0, 5	
	5 mA/5 V Code 8	

Contacts

Material	Standard	Code 0	⚡ AgNi
	Optional	Code 5	⚡ AgSnO ₂
Rated Load	10 A		
Max. inrush current (20 ms)	30 A (120 A for code 5)		
Switching voltage max.	250 V		
AC load fig. 1	2.5 kVA		
DC load	see fig. 2		

Coil

Coil resistance	see table; tolerance ± 10 %
Pick-up voltage	≤ 0.8 x U _N
Release voltage	≥ 0.1 x U _N
Nominal power	1.1 VA (AC)/0.7 W (DC)

Coil table

V AC	Ω	mA	V DC	Ω	mA
24	290	45	12	224	53
48	1200	23	24	742	32
115	7.300	9.5	48	3.500	13.7
230	28.800	4.7	110	19.900	5.5

Insulation

Contact open	2000 V
Contact/coil	5 kV
Insulation resistance at 500 V	≥ 1 GΩ
Insulation, IEC 61810-1	4 kV

Specifications

Ambient temperature operation/storage	-40 ... 70 °C / -40 ... 80 °C (no ice)
Pick-up time/bounce time	10 ms / ≤ 1 ms
Release time/bounce time	8 ms
Mechanical life ops	AC: 10 Mill./DC: 20 Mill.
DC voltage endurance at rated load	≥ 100 000 switching cycles
Max. switching frequency at rated load	1200/h
Weight	21g

Product References

V AC 50 Hz/60 Hz: 24, 48, 115 (120), 230 (240)	C10-G10/AC...V	C10-G15/AC...V
LED	C10-G10X/AC...V	C10-G15X/AC...V
RC Suppressor	C10-G10R/AC...V	C10-G15R/AC...V
V DC 12, 24, 48, 110	C10-G10/DC...V	C10-G15/DC...V
LED	C10-G10X/DC...V	C10-G15X/DC...V
Polarity and free wheeling diode	C10-G10FX/DC...V	C10-G15FX/DC...V
AC/DC bridge rectifier 24 V, 48 V	C10-G10BX/DC...V	C10-G15BX/UC...V
Other voltages on request		

"..." List Coil Voltage to complete Product References

Accessories

Socket	S10, S10-P
--------	------------



Connection diagram

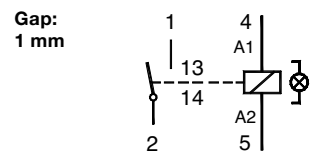


fig. 1 AC voltage endurance

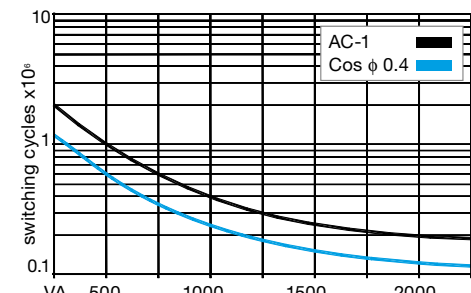
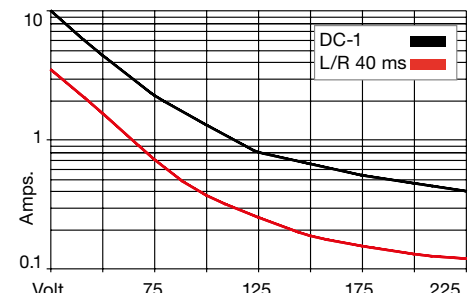
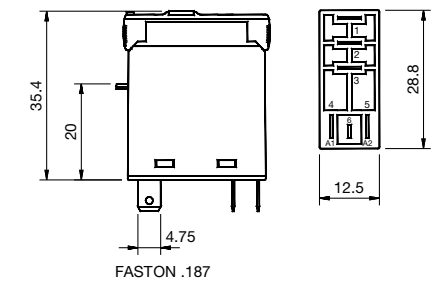


fig. 2 DC load limit curve



Dimensions (mm)



Technical approvals, conformities



C10-T1x

1 pole | changeover twin contact | Faston

Maximum contact load	6 A/250 V AC-1	0.5 A/110 V DC-1
	6 A/30 V DC-1	0.2 A/220 V DC-1
Recommended minimum contact load	5 mA/5 V Code 1	
	1 mA/5 V Code 3	

Contacts

Material	Standard	Code 1	AgNi + 0.2 μ Au
	Optional	Code 3	AgNi + 5 μ Au
Rated Load	6 A		
Max. inrush current (20 ms)	15 A		
Switching voltage max	250 V		
AC load fig. 1	1.5 kVA		
DC load	see fig. 2		

Coil

Coil resistance	see table; tolerance ± 10 %
Pick-up voltage	≤ 0.8 x U _N
Release voltage	≥ 0.1 x U _N
Nominal power	1.1 VA (AC)/0.7 W (DC)

Coil table

V AC	Ω	mA	V DC	Ω	mA
24	290	45	12	224	53
48	1200	23	24	742	32
115	7.300	9.5	48	3.500	13.7
230	28.800	4.7	110	19.900	5.5

Insulation

Contact open	1000 V
Contact/coil	5 kV
Insulation resistance at 500 V	≥ 1 GΩ
Insulation, IEC 61810-1	4 kV

Specifications

Ambient temperature operation/storage	-40 ... 70 °C / -40 ... 80 °C (no ice)
Pick-up time/bounce time	10 ms / ≤ 1 ms
Release time/bounce time	5 ms / ≤ 3 ms
Mechanical life ops	AC: 10 Mill./DC: 20 Mill.
DC voltage endurance at rated load	≥ 100 000 switching cycles
Max. switching frequency at rated load	1200/h
Weight	21 g

Product References

V AC 50 Hz/60 Hz: 24, 48, 115 (120), 230 (240)

LED

RC Suppressor

C10-T11/AC ... V
C10-T11X/AC ... V
C10-T11R/AC...V

C10-T13/AC ... V
C10-T13X/AC ... V
C10-T13R/AC...V

V DC 12, 24, 48, 110

LED

Polarity and free wheeling diode

C10-T11/DC ... V
C10-T11X/DC ... V
C10-T11FX/DC ... V

C10-T13/DC ... V
C10-T13X/DC ... V
C10-T13FX/DC ... V

AC/DC bridge rectifier 24 V, 48 V

Other voltages on request

C10-T11BX/UC ... V

C10-T13BX/UC ... V

"..." List Coil Voltage to complete Product References

Accessories

Socket **S10, S10-P**



Connection diagram

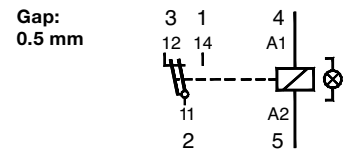


fig. 1 AC voltage endurance

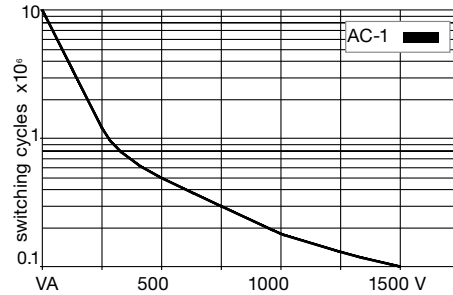
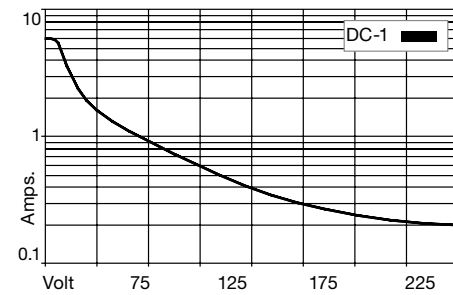
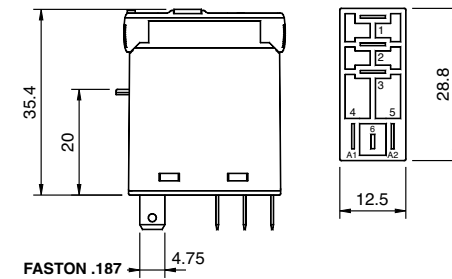


fig. 2 DC load limit curve



Dimensions (mm)



Technical approvals, conformities



IEC/EN 61810; IEC/EN 60947

C12-A2x

2 pole | changeover contact | Faston

Maximum contact load	5 A/250 V AC-1	0.5 A/110 V DC-1
	5 A/30 V DC-1	0.2 A/220 V DC-1
Recommended minimum contact load	10 mA/10 V Code 1	
	5 mA/5 V Code 2	

Contacts

Material	Standard	Code 1	AgNi + 0.2 μ Au
	Optional	Code 2	AgNi + 5 μ Au
Rated Load	5 A		
Max. inrush current (20 ms)	15 A		
Switching voltage max.	250 V		
AC load fig. 1	1.2 kVA		
DC load	see fig. 2		

Coil

Coil resistance	see table; tolerance ± 10 %
Pick-up voltage	≤ 0.8 x U _N
Release voltage	≥ 0.1 x U _N
Nominal power	1.1 VA (AC)/0.7 W (DC)

Coil table

V AC	Ω	mA	V DC	Ω	mA
24	290	45	12	224	53
48	1200	23	24	742	32
115	7.300	9.5	48	3.500	13.7
230	28.800	4.7	110	19.900	5.5

Insulation

Contact open	1000 V
Contact/contact	3000 V
Contact/coil	5 kV
Insulation resistance at 500 V	≥ 1 GΩ
Insulation, IEC 61810-1	4 kV

Specifications

Ambient temperature operation/storage	-40 ... 60 °C / -40 ... 80 °C (no ice)
Pick-up time/bounce time	10 ms / ≤ 1 ms
Release time/bounce time	5 ms / ≤ 3 ms
Mechanical life ops	AC: 10 Mill./DC: 20 Mill.
DC voltage endurance at rated load	≥ 100 000 switching cycles
Max. switching frequency at rated load	1200/h
Weight	21 g

Product References

V AC 50 Hz/60 Hz: 24, 48, 115 (120), 230 (240)

LED

RC Suppressor

C12-A21/AC ... V
C12-A21X/AC ... V
C12-A21R/AC ... V

C12-A22/AC ... V
C12-A22X/AC ... V
C12-A22R/AC ... V

V DC 12, 24, 48, 110

LED

Polarity and free wheeling diode

C12-A21/DC ... V
C12-A21X/DC ... V
C12-A21FX/DC ... V

C12-A22/DC ... V
C12-A22X/DC ... V
C12-A22FX/DC ... V

AC/DC bridge rectifier 24 V, 48 V

Other voltages on request

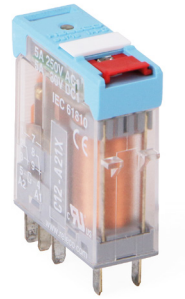
C12-A21BX/UC ... V

C12-A22BX/UC ... V

"..." List Coil Voltage to complete Product References

Accessories

Socket **S12, S12-P**



Connection diagram

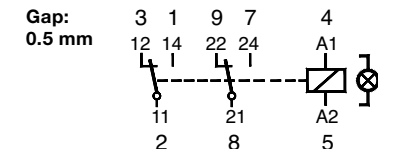


fig. 1 AC voltage endurance

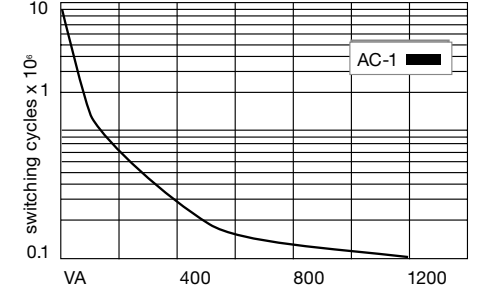
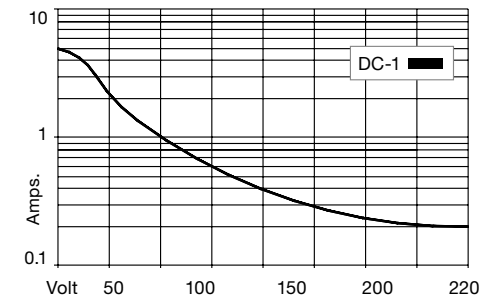
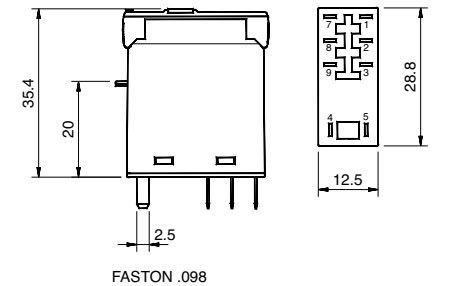


fig. 2 DC load limit curve



Dimensions (mm)



Technical approvals, conformities



IEC/EN 61810; IEC/EN 60947

C12-G2x

2 pole | normally open contact | Faston

Maximum contact load	5 A/250 V AC-1	0.8 A/110 V DC-1
	5 A/30 V DC-1	0.4 A/220 V DC-1
Recommended minimum contact load	10 mA/10 V Code 1	
	5 mA/5 V Code 2	

Contacts

Material	Standard	Code 1	AgNi + 0.2 μ Au
	Optional	Code 2	AgNi + 5 μ Au
Rated Load			5 A
Max. inrush current (20 ms)			15 A
Switching voltage max.			250 V
AC load fig. 1			1.2 kVA
DC load			see fig. 2

Coil

Coil resistance	see table; tolerance ± 10 %
Pick-up voltage	≥ 0.8 x U _N
Release voltage	≥ 0.1 x U _N
Nominal power	1.1 VA (AC)/0.7 W (DC)

Coil table

V AC	Ω	mA	V DC	Ω	mA
24	290	45	12	224	53
48	1200	23	24	742	32
115	7.300	9.5	48	3.500	13.7
230	28.800	4.7	110	19.900	5.5

Insulation

Contact open	2000 V
Contact/contact	3000 V
Contact/coil	5 kV
Insulation resistance at 500 V	≥ 1 G.Ω
Insulation, IEC 61810-1	4 kV

Specifications

Ambient temperature operation/storage	-40 ... 60 °C / -40 ... 80 °C (no ice)
Pick-up time/bounce time	10 ms / ≤ 1 ms
Release time/bounce time	5 ms / ≤ 3 ms
Mechanical life ops	AC: 10 Mill./DC: 20 Mill.
DC voltage endurance at rated load	≥ 100 000 switching cycles
Max. switching frequency at rated load	1200/h
Weight	21 g

Product References

V AC 50 Hz/60 Hz: 24, 48, 115, (120), 230, (240)

C12-G21/AC ... V	C12-G22/AC ... V
C12-G21X/AC ... V	C12-G22X/AC ... V
C12-G21R/AC ... V	C12-G22R/AC ... V

V DC 12, 24, 48, 110

C12-G21/DC ... V	C12-G22/DC ... V
C12G21X/DC ... V	C12-G22X/DC ... V
C12-G21FX/DC ... V	C12-G22FX/DC ... V

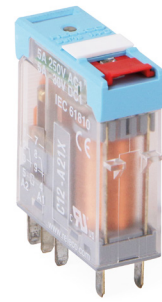
AC/DC bridge rectifier 24 V, 48 V

C12-G21BX/UC ... V	C12-G22BX/UC ... V
---------------------------	---------------------------

"..." List Coil Voltage to complete Product References

Accessories

Socket	S12, S12-P
--------	-------------------



Connection diagram

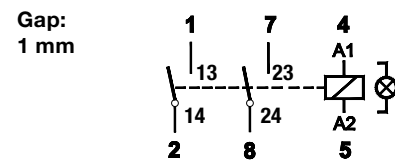


fig. 1 AC voltage endurance

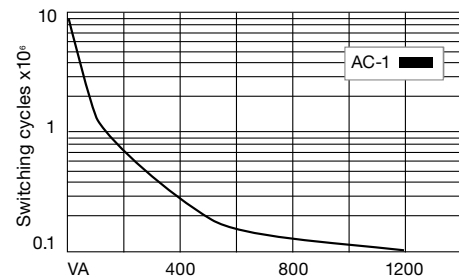
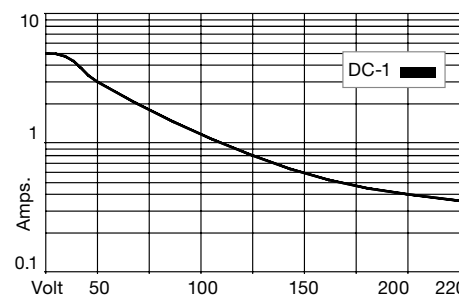
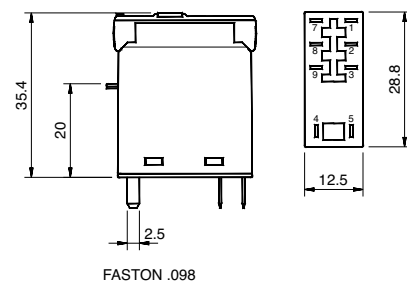


fig. 2 DC load limit curve



Dimensions (mm)



Technical approvals, conformities



C16-A25PTL

2 pole | 8-pin | changeover contact | Grid 5mm

Maximum contact load	7 A/250 V AC-1
	7 A/30 V DC-1
Recommended minimum contact load	1 mA/1 V AC/DC

Contacts

Material	AgSnO ₂
Rated Load	7 A
Switching voltage max.	250 V
Max. inrush current (500 ms)	15 A
Bounce time	2 ms

Coil

Coil resistance	see table; tolerance ± 10 %
Pick-up voltage	75 % of U _N (DC) / 80 % of U _N (AC)
Release voltage	≤ 0.1 U _N (DC) / ≤ 0.3 U _N (AC)
Nominal power	1 VA (AC)/0.53 W (DC) @ 23 °C

Coil Data (DC voltage)

Coil Voltage Code	Nominal Voltage (VDC)	Coil Resistance (Ω) ± 10%	Must operate voltage max. (VDC)	Must release voltage min (VDC)
12	12	270	9.00	1.2
24	24	1080	18.00	2.4
36	36	1350	27.00	3.6
48	48	4340	36.00	4.8
110	110	22830	82.5	11

Coil Data (AC voltage 50/60 Hz)

Coil Voltage Code	Nominal Voltage (VAC)	Coil Resistance (Ω) ± 10%	Must operate voltage max. (VAC)	Must release voltage min (VAC)	Max. allowable voltage (VAC)
24	24	253	19.2	7.2	26.4
110	110	5819	88.0	33	121
230	230	23276	184	69	253

Insulation

Insulation resistance (coil to contact)	≥ 100 MΩ @ 500 V DC, 50 % RH
Dielectric strength	5 kV
Contact/coil	5000 Vrms, 1 min
Contact/contact	1000 Vrms, 1 min

Specifications

Ambient temperature operation/storage	-55 ... 70 °C / -55 ... 70 °C (no ice)
Pick-up time	10 ms
Release time	5 ms
Mechanical/electrical life ops	≥ 1 x 10 000 000 / 1 x 100 000
Weight	17 g
Max. switching frequency	20 Hz
Tightness	RT2

Product References

V AC 50 Hz/60 Hz: 24, 110 (120), 230 (240)

V DC 12, 24, 48

Other voltages on request

"..." List Coil Voltage to complete Product References

Accessories

Socket	S16-M
Retaining clip, plastic	CP-16
Modules	See datasheet socket S16-M



Connection diagram

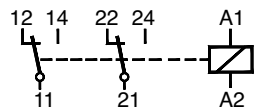
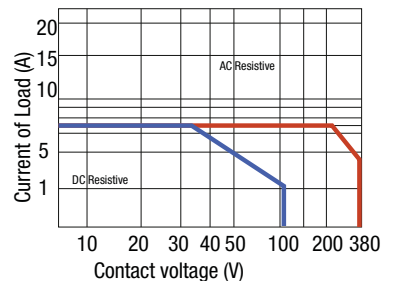
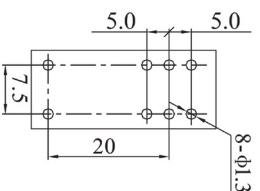
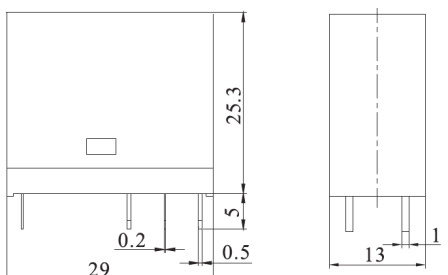


fig. 1 Max. Operating Power Curve



Dimensions (mm)



Technical approvals, conformities



C18-A15PT

1 pole | 5-pin | changeover contact | Grid 3.5mm

Maximum contact load	10 A/250V AC-1 10 A/30V DC-1
Recommended minimum contact load	1 mA/1V AC/DC

Contacts	
Material	AgSnO ₂
Rated Load	10A
Switching voltage max.	250V
Max. inrush current (500ms)	25A
Bounce time	2ms

Coil	
Coil resistance	see table; tolerance ± 10 %
Pick-up voltage	75 % of U _N (DC) / 80 % of U _N (AC)
Release voltage	≤ 0.1 U _N (DC) / ≤ 0.3 U _N (AC)
Nominal power	1 VA (AC) / 0.53 W (DC) @ 23 °C

Coil Data (DC voltage)					
Coil Voltage Code	Nominal Voltage (VDC)	Coil Resistance (Ω) ± 10 %	Must operate voltage max. (VDC)	Must release voltage min (VDC)	
12	12	270	9.00	1.2	
24	24	1080	18.00	2.4	
36	36	1350	27.00	3.6	
48	48	4340	36.00	4.8	
110	110	22830	82.5	11	

Coil Data (AC voltage 50/60Hz)					
Coil Voltage Code	Nominal Voltage (VAC)	Coil Resistance (Ω) ± 10 %	Must operate voltage max. (VAC)	Must release voltage min (VAC)	Max. allowable voltage (VAC)
24	24	253	19.2	7.2	26.4
110	110	5819	88.0	33	121
230	230	23276	184	69	253

Insulation	
Insulation resistance (coil to contact)	≥ 100 MΩ @ 500V DC, 50 % RH
Dielectric strength	5 kV
Contact/coil	5000 Vrms, 1 min
Contact/contact	1000 Vrms, 1 min

Specifications	
Ambient temperature operation/storage	-55 ... 70 °C / -55...70 °C (no ice)
Pick-up time	10ms
Release time	5ms
Mechanical/electrical life ops	≥ 1 × 10 000 000 / 1 × 100 000
Weight	17g
Max. switching frequency	20Hz
Tightness	RT2

Product References
V AC 50 Hz/60 Hz: 24, 110 (120), 230 (240)
V DC 12, 24, 36, 48, 110
 Other voltages on request

"..." List Coil Voltage to complete Product References

Accessories	
Socket	S18-M
Retaining clip, plastic	CP-16
Modules	See datasheet socket S18-M



Connection diagram

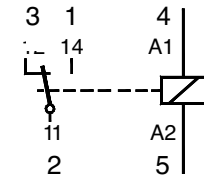
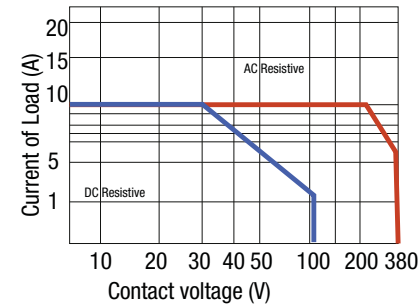
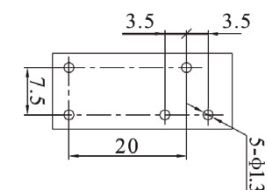
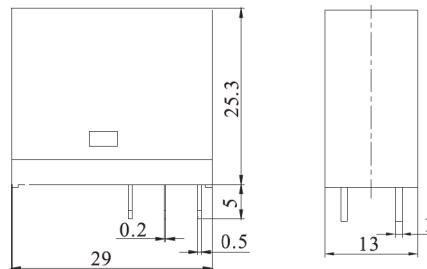


fig. 1 Max. Operating Power Curve



Dimensions (mm)



Standard

Technical approvals, conformities



IEC/EN 61810; IEC/EN 60947

C18-A15PTL

1 pole | 5-pin | changeover contact | Grid 5mm

Maximum contact load	10 A/250V AC-1 10 A/30V DC-1
Recommended minimum contact load	1 mA/1V AC/DC

Contacts	
Material	AgSnO ₂
Rated Load	10A
Switching voltage max.	250V
Max. inrush current (500ms)	25A
Bounce time	2ms

Coil	
Coil resistance	see table; tolerance ± 10 %
Pick-up voltage	75 % of U _N (DC) / 80 % of U _N (AC)
Release voltage	≤ 0.1 U _N (DC) / ≤ 0.3 U _N (AC)
Nominal power	1 VA (AC) / 0.53 W (DC) @ 23 °C

Coil Data (DC voltage)					
Coil Voltage Code	Nominal Voltage (VDC)	Coil Resistance (Ω) ± 10 %	Must operate voltage max. (VDC)	Must release voltage min (VDC)	
12	12	270	9.00	1.2	
24	24	1080	18.00	2.4	
36	36	1350	27.00	3.6	
48	48	4340	36.00	4.8	
110	110	22830	82.5	11	

Coil Data (AC voltage 50/60Hz)					
Coil Voltage Code	Nominal Voltage (VAC)	Coil Resistance (Ω) ± 10 %	Must operate voltage max. (VAC)	Must release voltage min (VAC)	Max. allowable voltage (VAC)
24	24	253	19.2	7.2	26.4
110	110	5819	88.0	33	121
230	230	23276	184	69	253

Insulation	
Insulation resistance (coil to contact)	≥ 100 MΩ @ 500V DC, 50 % RH
Dielectric strength	5 kV
Contact/coil	5000 Vrms, 1 min
Contact/contact	1000 Vrms, 1 min

Specifications	
Ambient temperature operation/storage	-55 ... 70 °C / -55...70 °C (no ice)
Pick-up time	10ms
Release time	5ms
Mechanical/electrical life ops	≥ 1 × 10 000 000 / 1 × 100 000
Weight	17g
Max. switching frequency	20Hz
Tightness	RT2

Product References
V AC 50 Hz/60 Hz: 24, 110 (120), 230 (240)
V DC 12, 24, 36, 48, 110
 Other voltages on request

"..." List Coil Voltage to complete Product References

Accessories	
Socket	S16-M
Retaining clip, plastic	CP-16
Modules	See datasheet socket S16-M



Connection diagram

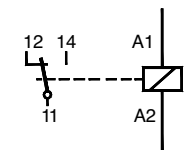
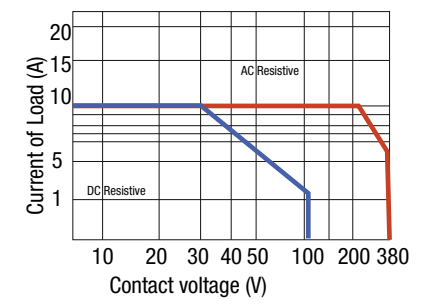
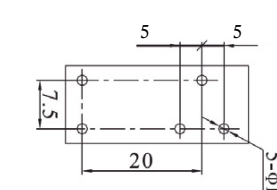
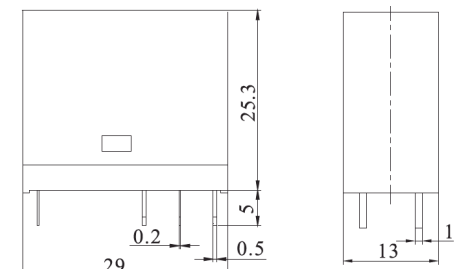


fig. 1 Max. Operating Power Curve



Dimensions (mm)



Standard

Technical approvals, conformities



IEC/EN 61810; IEC/EN 60947

C18-B15PTL

1 pole | 8-pin | changeover contact | Grid 5mm

Maximum contact load	16 A/250V AC-1 16 A/30V DC-1
Recommended minimum contact load	1 mA/1V AC/DC

Contacts	
Material	AgSnO ₂
Rated Load	16 A
Switching voltage max.	250 V
Max. inrush current (500ms)	25 A
Bounce time	2 ms

Coil	
Coil resistance	see table; tolerance ± 10 %
Pick-up voltage	75 % of U _N (DC) / 80 % of U _N (AC)
Release voltage	≤ 0.1 U _N (DC) / ≤ 0.3 U _N (AC)
Nominal power	1 VA (AC) / 0.53 W (DC) @ 23 °C

Coil Data (DC voltage)				
Coil Voltage Code	Nominal Voltage (VDC)	Coil Resistance (Ω) ± 10 %	Must operate voltage max. (VDC)	Must release voltage min (VDC)
12	12	270	9.00	1.2
24	24	1080	18.00	2.4
36	36	1350	27.00	3.6
48	48	4340	36.00	4.8
110	110	22830	82.5	11

Coil Data (AC voltage 50/60 Hz)					
Coil Voltage Code	Nominal Voltage (VAC)	Coil Resistance (Ω) ± 10 %	Must operate voltage max. (VAC)	Must release voltage min (VAC)	Max. allowable voltage (VAC)
24	24	253	19.2	7.2	26.4
110	110	5819	88.0	33	121
230	230	23276	184	69	253

Insulation	
Insulation resistance (coil to contact)	≥ 100 MΩ @ 500V DC, 50 % RH
Dielectric strength	5 kV
Contact/coil	5000 Vrms, 1 min
Contact/contact	1000 Vrms, 1 min

Specifications	
Ambient temperature operation/storage	-55 ... 70 °C / -55...70 °C (no ice)
Pick-up time	10 ms
Release time	5 ms
Mechanical / electrical life ops	≥ 1 × 10 000 000 / 1 × 100 000
Weight	17 g
Max. switching frequency	20 Hz
Tightness	RT2

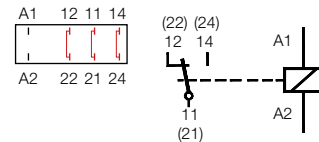
Product References	
V AC 50 Hz/60 Hz: 24, 110 (120), 230 (240)	C18-B15PTL/AC...V
V DC 12, 24, 36, 48, 110	C18-B15PTL/DC...V
Other voltages on request	

"..." List Coil Voltage to complete Product References

Accessories	
Socket	S16-M
Retaining clip, plastic	CP-16
Modules	See datasheet socket S16-M

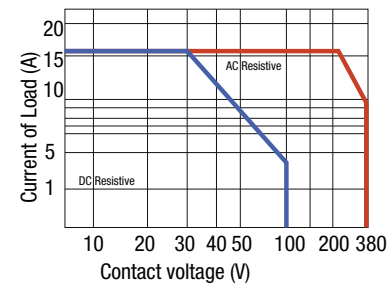


Connection diagram

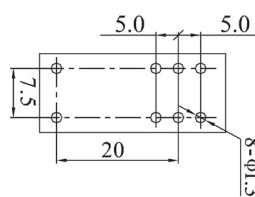
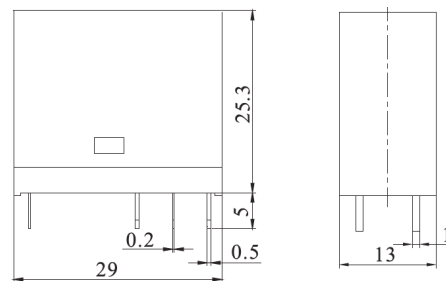


⚠ For usage of the relay up to 16A, pin 22+12 (open), pin 21+11 (common) and pin 24+14 (closing) need to be bridged on the socket terminals to prevent overheating. Each contact on this relay is connected to two pins each.

fig. 1 Max. Operating Power Curve



Dimensions (mm)



Technical approvals, conformities

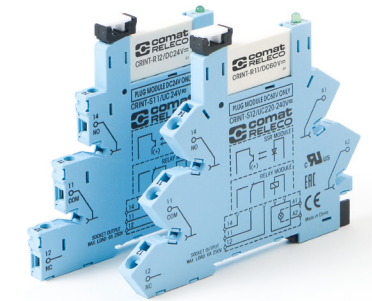


IEC/EN 61810; IEC/EN 60947

1.2 Interface Relays

Application	Type	Page
CRINT Series		
1 pole changeover contact	CRINT-1x1	27
1 pole changeover contact	CRINT-1x2	28
1 pole normally open solid state DC	CRINT-1x5	78
1 pole normally open solid state AC	CRINT-1x8	79
CINT Series		
1 pole changeover contact	CINT-51 / CINT-61	29
2 pole changeover contact	CINT-52 / CINT-62	30
2 pole changeover contact	CINT-53 / CINT-63	31
CHA Series		
1 pole changeover contact, 1 pole auxiliary contact	CHA1	32

1.2 Interface Relays
CRINT 1x1 series
1 pole | changeover contact



Maximum contact load	6 A/250 V AC-1	6 A/30 V DC-1
Recommended minimum contact load	100 mA / 12 V	

Contact	
Type	1 CO
Material	AgSnO ₂
Switching current I _{TH}	6 A 250 V AC
Switching power DC-1 30 V	180 W
Switching power AC-1 230 V	1500 VA
Switching power AC-15 230 V	300 VA
Max. inrush current (2.5 ms)	15 A

Coil	
Operation voltage AC 50/60 Hz / DC	0.8 ... 1.25 U _N
Nominal power DC/AC	408 / 900 mW

Insulation	
Test voltage I / O	6 kV rms / 1 min
Pollution degree	3
Over voltage category	III
Open contact	1000 Vrms dielectric strength 1 min
Standard	EN61810-1

Specifications	
Ambient temperature: operation / storage	-40 ... 70 °C / -40 ... 85 °C (no ice)
Typical response time @ V _n	7 ms
Typical release time @ V _n	15 ms
Switching cycles: mech./elec.	10 x 1000000 / 3 x 10000
Cond. cross section screw terminal	2.5 mm ²
Cond. cross section spring cage	0.75 ... 2.5 mm ²
Protection degree	IP 20
Mounting position	any, TS35 or Back Panel Mounting
Weight	30 g

Product References	
Screw terminal	CRINT-C111/UC...V
UC 12V, 24V, 48V, 60V, 110-125V, 220-240V	
Cage clamp terminal	CRINT-C121/UC...V
UC 12V, 24V, 48V, 60V, 110-125V, 220-240V	
Railway EN 50155	CRINT-C121R/UC...V
...“ List Coil Voltage to complete Product References	

Accessories	
Jumper link	blue: CRINT-BR20-BU (BAG 5 PCS) red: CRINT-BR20-RD (BAG 5 PCS) black: CRINT-BR20-BK (BAG 5 PCS)
Label plate	CRINT-LAB (BAG 4x16 PCS)
Spacer	CRINT-SEP (BAG 5 PCS)

Replacement relays	
DC 12V, 24V, 48V, 60V*	CRINT-R11/DC...V
...“ List Coil Voltage to complete Product References	

*60V Relay used for all sockets with a nominal voltage higher or equal 60V

Connection diagram

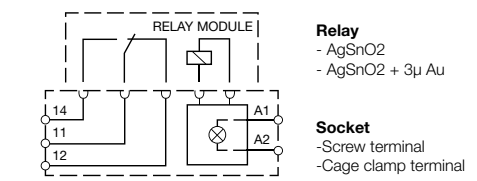


fig. 1 AC voltage endurance

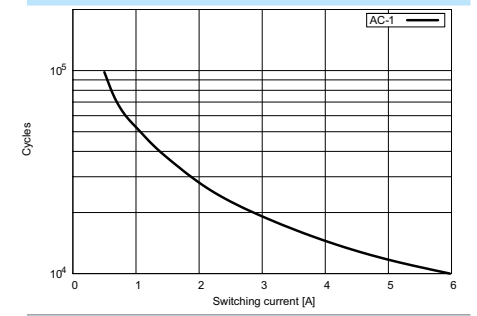
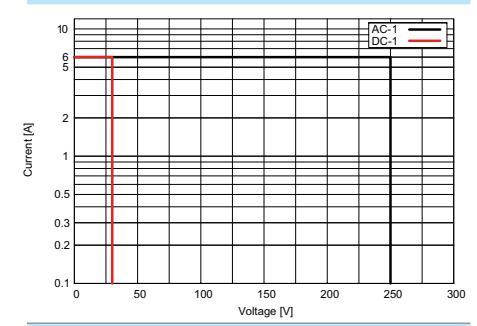
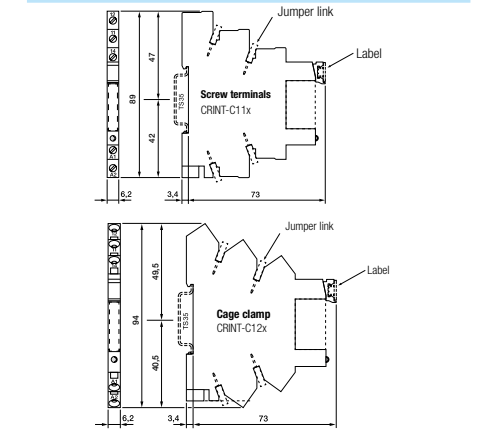


fig. 2 DC load limit curve



Dimensions (mm)



Technical approvals, conformities



CRINT Product Key

1		2	3	4	5	6	7	8
CRINT	-	C	1	1	1	R	/	UC 24V

- | | |
|--|--|
| 1. Product family
CRINT | 5. Output
1 = AgSnO ₂
2 = AgSnO ₂ + 3µ Au
5 = NO / Solid-state DC
8 = NO / Solid-state AC |
| 2. Type
C = Combined version (Socket and Relay) | 6. Options
- = Standard version
R = Railway version |
| 3. Contact
1 = One change-over contact | 7. Supply voltage
UC = AC/DC
DC = Only for C1x5 and C1x8 |
| 4. Connection type
1 = Screw terminal
2 = Cage clamp terminal | 8. Nominal voltage
12V, 24V, 48V, 60V, 110-125V, 220-240V |

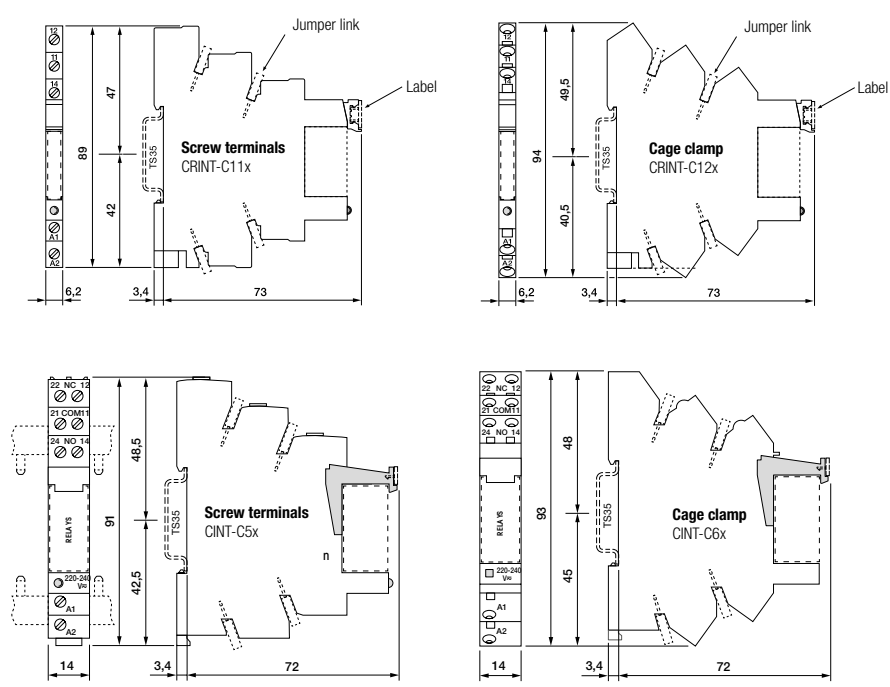
RELAY Only

1		2	3	4	5
CRINT	-	R	11	DC	12V

- | | |
|---|--|
| 1. Product family
CRINT | 4. Supply voltage
DC |
| 2. Type
R = Relay | 5. Nominal voltage
12 V, 24 V, 48 V, 60 V* |
| 3. Contact
11 = AgSnO ₂
12 = AgSnO ₂ + 3µ Au
15 = NO / Solid-state DC
18 = NO / Solid-state AC | |

*60 V Relay used for all sockets with a nominal voltage higher or equal 60V

CRINT-C1xx & CINT-C5x/C6x **Dimensions (mm)**



CRINT 1x2 series

1 pole | changeover contact

Maximum contact load	6 A/250 V AC-1	6 A/30 V DC-1
Recommended minimum contact load	10 mA / 6 V	
Contact		
Type	1 CO	
Material	AgSnO ₂ + 5μ Au	
Switching current _{TH}	6 A 250 V AC	
Switching power DC-1 30 V	180 W	
Switching power AC-1 230 V	1500 VA	
Switching power AC-15 230 V	300 VA	
Max. inrush current (2.5 ms)	15 A	
Coil		
Operation voltage AC 50/60 Hz / DC	0.8 ... 1.25 U _N	
Nominal power DC/AC	408 / 900 mW	
Insulation		
Test voltage I / O	6 kV rms / 1 min	
Pollution degree	3	
Over voltage category	III	
Open contact	1000 Vrms dielectric strength 1 min	
Standard	EN61810-1	
Specifications		
Ambient temperature: operation / storage	-40 ... 70 °C / -40 ... 85 °C (no ice)	
Typical response time @ V _n	7 ms	
Typical release time @ V _n	15 ms	
Switching cycles: mech./elec.	10 x 1000000 / 3 x 10000	
Cond. cross section screw terminal	2.5 mm ²	
Cond. cross section spring cage	0.75 ... 2.5 mm ²	
Protection degree	IP 20	
Mounting position	any, TS35 or Back Panel Mounting	
Weight	30 g	

Product References

Screw terminal
UC 12V, 24V, 48V, 60V, 110-125V, 220-240V
 Cage clamp terminal
UC 12V, 24V, 48V, 60V, 110-125V, 220-240V
Railway EN 50155
 "...“ List Coil Voltage to complete Product References

CRINT-C112/UC...V
CRINT-C122/UC...V
CRINT-C122R/UC...V

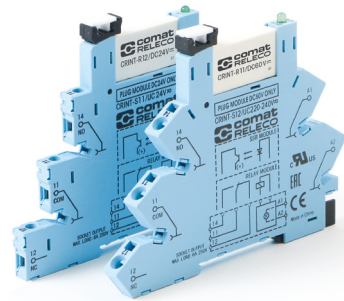
Accessories

Jumper link
 blue: **CRINT-BR20-BU (BAG 5 PCS)**
 red: **CRINT-BR20-RD (BAG 5 PCS)**
 black: **CRINT-BR20-BK (BAG 5 PCS)**
 Label plate **CRINT-LAB (BAG 4x16 PCS)**
 Spacer **CRINT-SEP (BAG 5 PCS)**

Replacement relays

DC 12V, 24V, 48V, 60V*
 "...“ List Coil Voltage to complete Product References

*60V Relay used for all sockets with a nominal voltage higher or equal 60V



Connection diagram

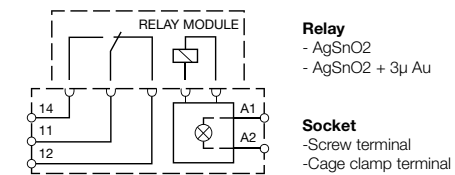


fig. 1 AC voltage endurance

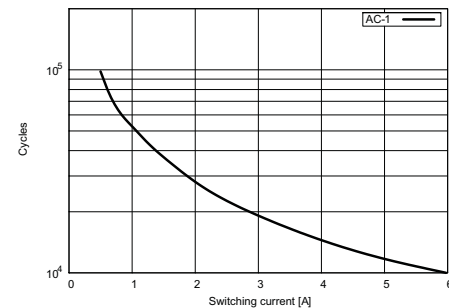
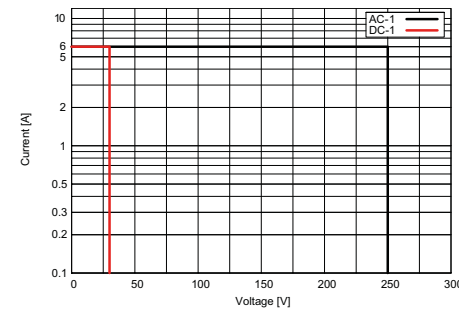
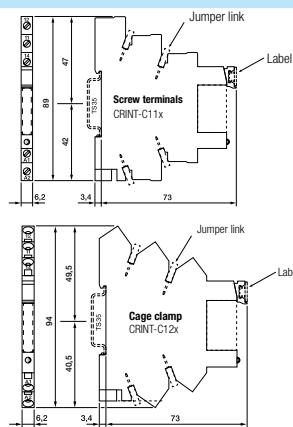


fig. 2 DC load limit curve



Dimensions (mm)



Technical approvals, conformities



CINT-51 / CINT-61

1 pole | changeover contact

Maximum contact load	10 A (16 A)/250 V AC-1
Recommended minimum contact load	10 mA / 24 V
Contact	
Type	1 CO
Material	AgSnO ₂
Switching current _{TH}	16 A
Max. inrush current (5 ms)	30 A
Coil	
Operation voltage AC 50/60 Hz / DC	0.7 ... 1.25 U _N
Nominal power DC/AC	480 mW / 780 mW
Insulation	
Test voltage I / O	4000 Vrms / 1min
Pollution degree	3
Over voltage category	III
Open contact	1000 Vrms
Standard	EN61810-1
Specifications	
Ambient temperature: operation / storage	-20 ... 55 °C / -40 ... 85 °C (no ice)
Typical response time @ V _n	5 ms
Typical release time @ V _n	10 ms
Cond. cross section screw terminal	2.5 mm ²
Cond. cross section spring cage	0.5 ... 2.5 mm ²
Protection degree	IP 20
Mounting position	any
Weight	63 g

Product References

Screw terminal **UC24V, AC230V** **CINT-51/...V**
 Cage clamp terminal **UC24V, AC230V** **CINT-61/...V**
 "...“ List Coil Voltage to complete Product References

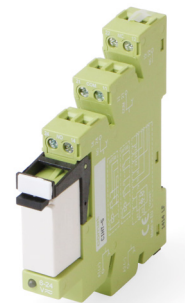
Accessories

Jumper link black: **CINT-BR8/5**
 Label plate **CINT5-BEZ/18**

Replacement relays

DC 24V, 110V **CINT-R21/DC...V**
 "...“ List Coil Voltage to complete Product References

*24V Relay used for 24 V sockets, 110V Relay used for 230V sockets.



Connection diagram

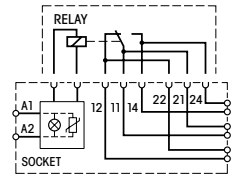


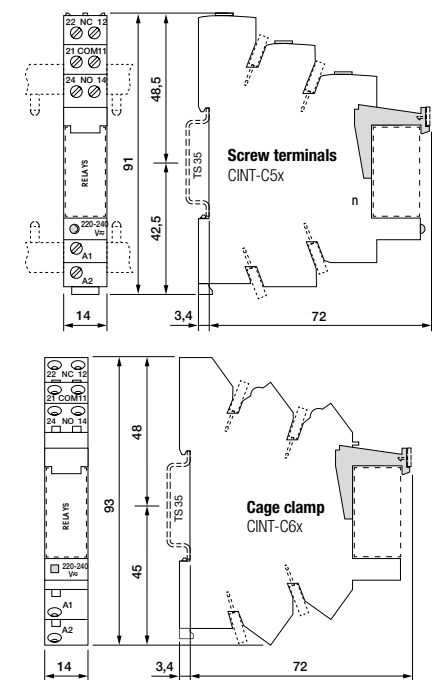
fig. 1 AC voltage endurance

on request

fig. 2 DC load limit curve

on request

Dimensions (mm)



Technical approvals, conformities



1.2 Interface Relays
CINT-52 / CINT-62

2 pole | changeover contact

Maximum contact load	8 A/250 V AC-1
Recommended minimum contact load	5 mA / 5 V
Contact	
Type	2 CO
Material	AgNi + 5µ Au
Switching current _{TH}	8 A
Max. inrush current (20 ms)	15 A

Coil	
Operation voltage AC 50/60 Hz / DC	0.7 ... 1.25 U _N
Nominal power DC/AC	480 mW / 780 mW

Insulation	
Test voltage I / O	4000 Vrms / 1min
Pollution degree	3
Over voltage category	III
Open contact	1000 Vrms
Standard	EN61810-1

Specifications	
Ambient temperature: operation / storage	-20 ... 55 °C / -40 ... 85 °C (no ice)
Typical response time @ V _n	5 ms
Typical release time @ V _n	10 ms
Cond. cross section screw terminal	2.5 mm ²
Cond. cross section spring cage	0.5 ... 2.5 mm ²
Protection degree	IP 20
Mounting position	any
Weight	63 g

Product References	
Screw terminal UC24V, AC230V	CINT-52/...V
Cage clamp terminal UC24V, AC230V	CINT-62/...V
"...“ List Coil Voltage to complete Product References	

Accessories	
Jumper link	black: CINT-BR8/5
Label plate	CINT5-BEZ/18

Replacement relays	
DC 24V, 110V	CINT-R22/DC...V
"...“ List Coil Voltage to complete Product References	

*24V Relay used for 24 V sockets,
 110V Relay used for 230V sockets.



Connection diagram

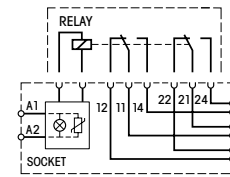


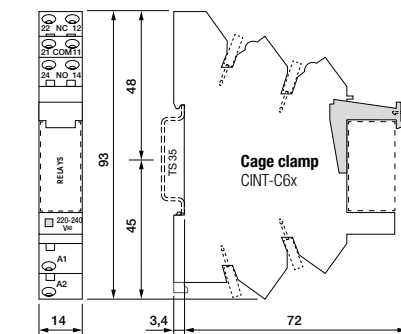
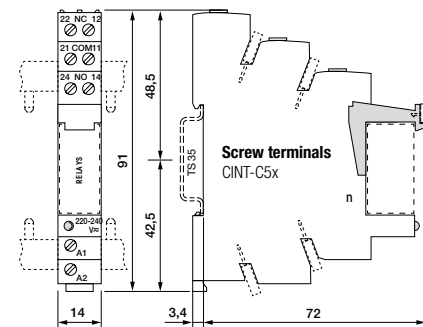
fig. 1 AC voltage endurance

on request

fig. 2 DC load limit curve

on request

Dimensions (mm)



Technical approvals, conformities



IEC/EN 61810

1.2 Interface Relays
CINT-53 / CINT-63

2 pole | changeover contact

Maximum contact load	8 A/250 V AC-1
Recommended minimum contact load	10 mA / 24 V
Contact	
Type	2 CO
Material	AgNi
Switching current _{TH}	8 A
Max. inrush current (20 ms)	15 A

Coil	
Operation voltage AC 50/60 Hz / DC	0.7 ... 1.25 U _N
Nominal power DC/AC	480 mW / 780 mW

Insulation	
Test voltage I / O	4000 Vrms / 1min
Pollution degree	3
Over voltage category	III
Open contact	1000 Vrms
Standard	EN61810-1

Specifications	
Ambient temperature: operation / storage	-20 ... 55 °C / -40 ... 85 °C (no ice)
Typical response time @ V _n	5 ms
Typical release time @ V _n	10 ms
Cond. cross section screw terminal	2.5 mm ²
Cond. cross section spring cage	0.5 ... 2.5 mm ²
Protection degree	IP 20
Mounting position	any
Weight	63 g

Product References	
Screw terminal UC24V, AC230V	CINT-53/...V
Cage clamp terminal UC24V, AC230V	CINT-63/...V
"...“ List Coil Voltage to complete Product References	

Accessories	
Jumper link	black: CINT-BR8/5
Label plate	CINT5-BEZ/18

Replacement relays	
DC 24V, 110V	CINT-R23/DC...V
"...“ List Coil Voltage to complete Product References	

*24V Relay used for 24 V sockets,
 110V Relay used for 230V sockets.



Connection diagram

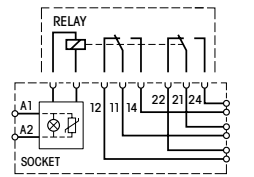


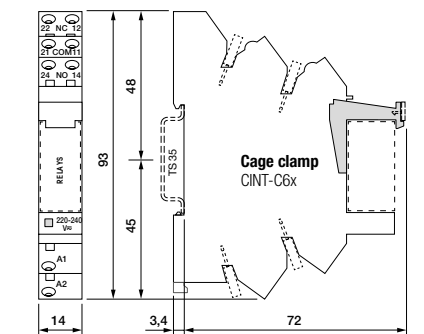
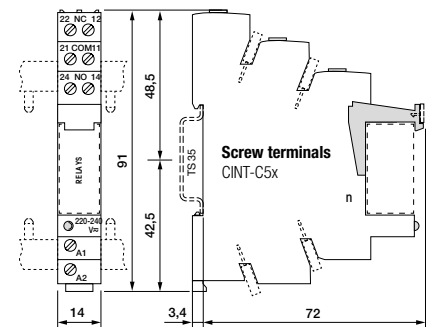
fig. 1 AC voltage endurance

on request

fig. 2 DC load limit curve

on request

Dimensions (mm)



Technical approvals, conformities



IEC/EN 61810

CHA1

1 pole changeover contact, 1 pole auxiliary contact

Maximum contact load	10 A/250 V AC-1	0.3 A/24 V DC-1
Recommended minimum contact load	10 mA / 12 V	

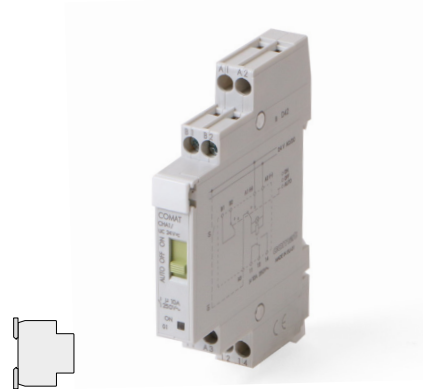
Contact	Power cont.	Signal cont.
Type	1CO	1NC
Material	AgSnO ₂	AgNi
Switching current _{TH}	10 A	0.3 A
Max. inrush current (20 ms)	15 A	-

Coil	
Operation voltage AC 50/60 Hz / DC	0.8 ... 1.1 U _N
Nominal power DC/AC	400 mW / 400 mW

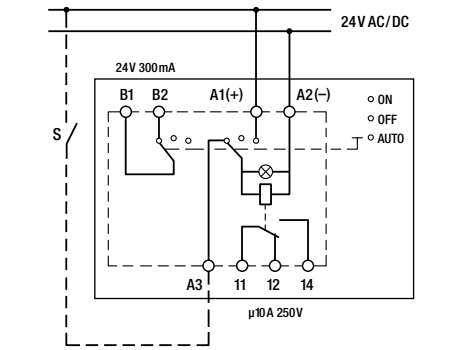
Insulation	
Test voltage I / O	3000 Vrms / 1min
Pollution degree	3
Over voltage category	III
Open contact	1000 Vrms
Standard	EN61810-1

Specifications	
Ambient temperature: operation / storage	-20 ... 55 °C / -40 ... 85 °C (no ice)
Typical response time @ V _n	on request
Typical release time @ V _n	on request
Cond. cross section screw terminal	2.5 mm ²
Protection degree	IP 20
Mounting position	any
Weight	42 g

Product References
CHA1/UC24V



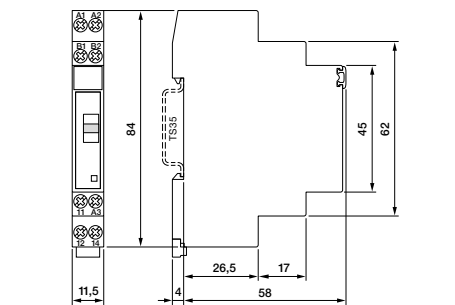
Connection diagram



Function Table

Green ON-OFF-switch	Control input A3	Relay / LED	Check back contact
AUTO	1	1	1
	0	0	1
ON	-	1	0
OFF	-	0	0

Dimensions (mm)



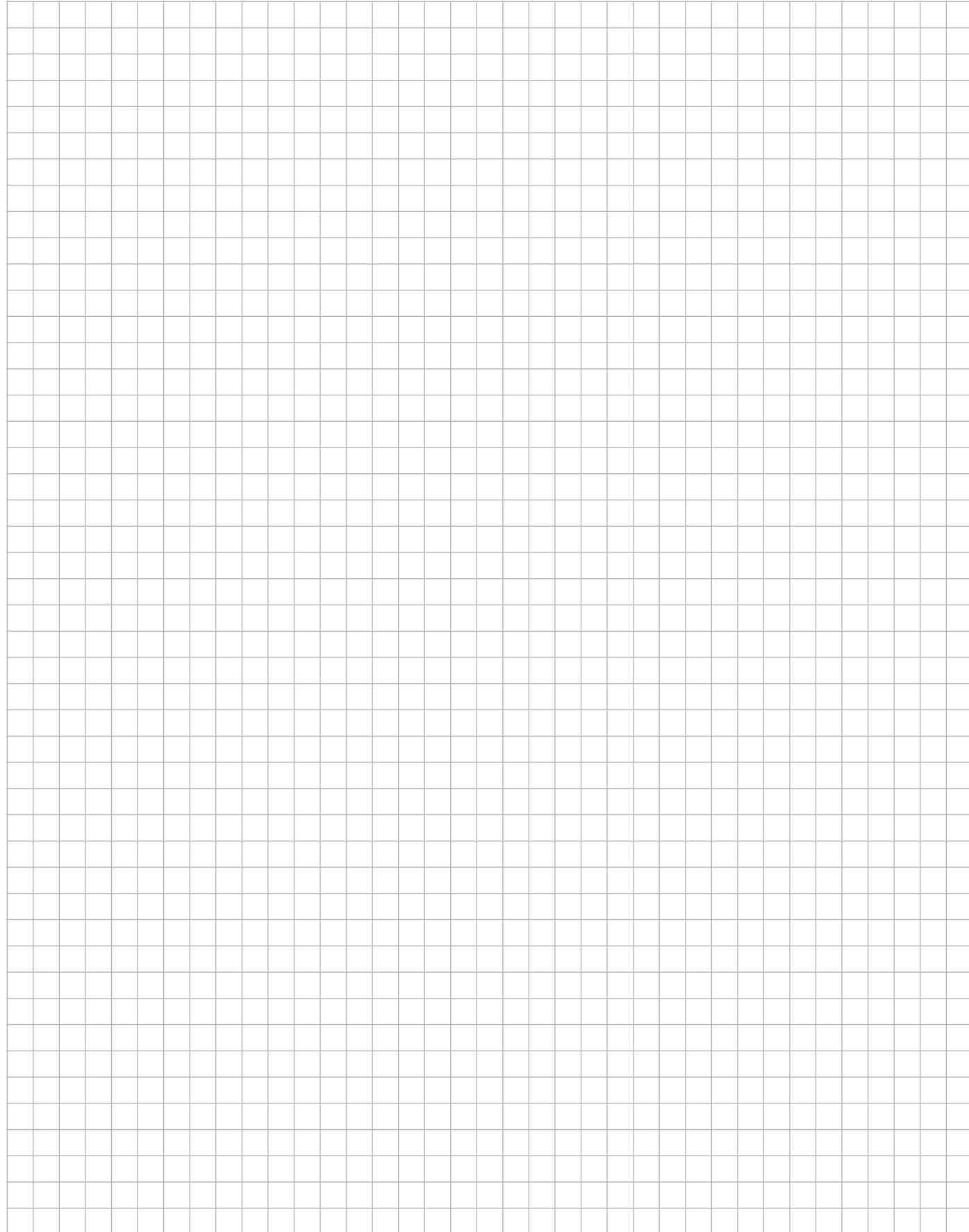
Technical approvals, conformities



1.3 Industrial Relays - pluggable

Application	Type	Pin	Page
C2 Series			
2 pole changeover contact	C2-A2x		36
C3 Series			
3 pole changeover contact	C3-A3x		37
3 pole changeover twin contact	C3-T3x		38
3 pole normally open contact	C3-G3x		39
1 pole normally open serial contact with blow magnet	C3-M1x		40
1 pole normally open serial contact	C3-X1x		41
2 pole changeover contact remanance	C3-R2x		42
3 pole changeover contact sensitive coil	C3-N3x		43
C4 Series			
4 pole changeover contact Faston	C4-A4x		44
2 pole normally open serial contact Faston	C4-X2x		45
3 pole changeover contact remanance	C4-R3x		46
C5 Series			
2 pole changeover contact Faston	C5-A2x		47
3 pole changeover contact Faston	C5-A3x		48
3 pole normally open contact Faston	C5-G3x		49
1 pole normally open serial contact Faston	C5-X1x		50
1 pole normally open serial contact with blow magnet Faston	C5-M1x		51
2 pole normally open contact with blow magnet Faston	C5-M2x		52
2 pole changeover contact remanance	C5-R2x		53

Notes



Application	Type	Pin	Page
C7 Series			
1 pole changeover contact Faston	C7-A1x		54
2 pole changeover contact Faston	C7-A2x		55
2 pole changeover twin contact	C7-T2x		56
2 pole normally open contact Faston	C7-G2x		57
2 pole changeover contact Faston	C7-H2x		58
1 pole normally open serial contact Faston	C7-X1x		59
1 pole normally open tungsten pre-contact Faston	C7-W1x		60
R7 Series			
2 pole changeover contact Faston	R7-A2x		61
2 pole changeover twin contact	R7-T2x		62
C9 Series			
4 pole changeover contact Faston	C9-A4x		63
2 pole changeover contact sensitive coil Faston	C9-E2x		64
2 pole changeover contact remanance Faston	C9-R2x		65

C2-A2x

2 pole | changeover contact

Maximum contact load	10 A/250 V AC-1	0.5 A/110 V DC-1
	10 A/30 V DC-1	0.2 A/220 V DC-1
Recommended minimum contact load	10 mA/10 V Code 0	
	5 mA/5 V Code 8	

Contacts

Material	Standard	Code 0	⚡ AgNi
	Optional	Code 8	⚡ AgNi + 5 μ Au
Max. switching current	10 A		
Max. peak inrush current (20 ms.)	30 A		
Max. switching voltage	250 V		
Max. AC load fig. 1	2.5 kVA		
Max. DC load	See fig. 2		

Coils

Coil resistance	see table; tolerance ± 10 %
Pick up voltage	≤ 0.8 x U _N
Pick up voltage	≥ 0.1 x U _N
Nominal power	2.2 VA (AC)/1.3 W (DC)

Coil Table

V AC	Ω	mA	V DC	Ω	mA
24	67	92	24	443	54
48	296	46	48	1K8	27
115	1K7	19	110	9K	12
230	7K1	9.5	220	36K1	6

Insulation

Open contact	1000 V
Between adjacent poles	2.5 kV
Between contacts and coil	2.5 kV
Insulation resistance at 500 V	≥ 1 GΩ
Insulation, IEC 61810-1	2.5 kV

Specifications

Ambient temperature operation/storage	-40...60 °C / -40 ... 80 °C (no ice)
Pick-up time + bounce time	16 ms / ≤ 3 ms
Release time + bounce time	8 ms / ≤ 1 ms
Mechanical life ops	AC: 10 Mill./DC: 20 Mill.
DC voltage endurance at rated load	≥ 100 000 ops. switching cycles
Max. switching frequency at rated load	1200/h
Weight	79 g

Product References

V AC 50 Hz/60 Hz: 24, 48, 115 (120), 230 (240)

LED

RC Suppressor

V DC 24, 48, 110, 220

LED

Free wheeling diode

Polarity and free wheeling diode

AC/DC bridge rectifier 24 V, 48 V, 60 V

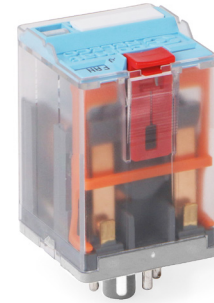
Other voltages on request

"..." List Coil Voltage to complete Product References

Accessories (See also Section Sockets)

Socket
Blanking Plug

S2-B, S2-PO
SO-NP (BAG 10 PCS)



Connection diagram

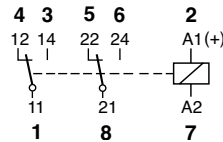


fig. 1 AC voltage endurance

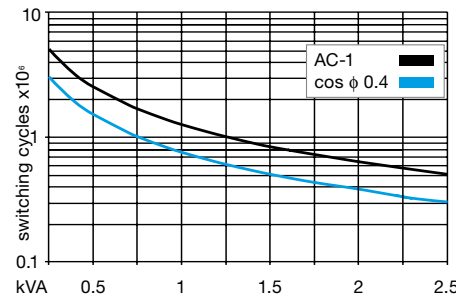
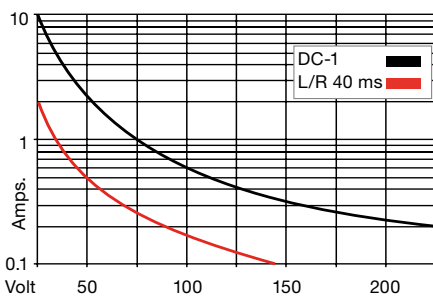
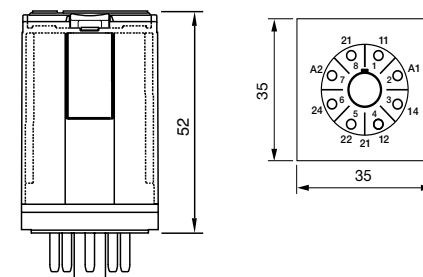


fig. 2 DC load limit curve



Dimensions (mm)



Technical approvals, conformities



C3-A3x

3 pole | changeover contact

Maximum contact load	10 A/250 AC-1	0.5 A/110 V DC-1
	10 A/30 DC-1	0.2 A/220 V DC-1
Recommended minimum contact load	10 mA/10 V Code 0, 9	
	5 mA/5 V Code 8	

Contacts

Material	Standard	Code 0	⚡ AgNi
	Optional	Code 8	⚡ AgNi + 5 μ Au
	Optional	Code 9	⚡ AgNi + 0.2 μ Au
Rated Load	10 A		
Max. inrush current (20 ms)	30 A		
Switching voltage max.	250 V		
AC load fig. 1	2.5 kVA		
DC load	see fig. 2		

Coil

Coil resistance	see table; tolerance ± 10 %
Pick-up voltage	≤ 0.8 x U _N
Release voltage	≥ 0.1 x U _N
Nominal power	2.2 VA (AC)/1.3 W (DC)

Coil table

V AC	Ω	mA	V DC	Ω	mA
24	67	92	24	480	50
48	296	46	48	1K8	26
115	1K7	19	110	9K	12
230	7K1	9.5	220	36K1	6

Insulation

Contact open	1000 V
Contact/contact	2.5 kV
Contact/coil	2.5 kV
Insulation resistance at 500 V	≥ 1 GΩ
Insulation, IEC 61810-1	2.5 kV

Specifications

Ambient temperature operation/storage	-40...60 °C / -40 ... 80 °C (no ice)
Pick-up time/bounce time	16 ms / ≤ 3 ms
Release time/bounce time	8 ms / ≤ 1 ms
Mechanical life ops	AC: 10 Mill./DC: 20 Mill.
DC voltage endurance at rated load	≥ 100 000 switching cycles
Max. switching frequency at rated load	1200/h
Weight	81 g

Product References

V AC 50 Hz/60 Hz: 24, 48, 115 (120), 230 (240)

LED

RC Suppressor

V DC 24, 48, 110, 220

LED

Free wheeling diode

Polarity and free wheeling diode

AC/DC bridge rectifier 24 V, 48 V, 60 V

Other voltages on request

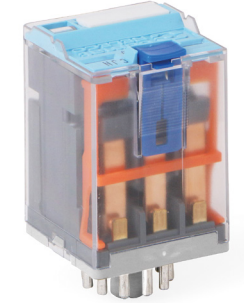
"..." List Coil Voltage to complete Product References

Accessories

Socket
Blanking Plug

C3-A30/AC ... V	C3-A38/AC ... V	C3-A39/AC ... V
C3-A30X/AC ... V	C3-A38X/AC ... V	C3-A39X/AC ... V
C3-A30R/AC ... V	C3-A38R/AC ... V	C3-A39R/AC ... V
C3-A30/DC ... V	C3-A38/DC ... V	C3-A39/DC ... V
C3-A30X/DC ... V	C3-A38X/DC ... V	C3-A39X/DC ... V
C3-A30DX/DC ... V	C3-A38DX/DC ... V	C3-A39DX/DC ... V
C3-A30FX/DC ... V	C3-A38FX/DC ... V	C3-A39FX/DC ... V
C3-A30BX/UC ... V	C3-A38BX/UC ... V	C3-A39BX/UC ... V

S3-B, S3-S, S3-PO, S3-M, S3-M0, S3-M1
SO-NP (BAG 10 PCS)



Connection diagram

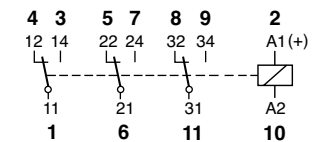


fig. 1 AC voltage endurance

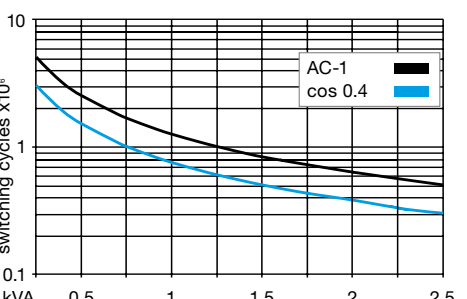
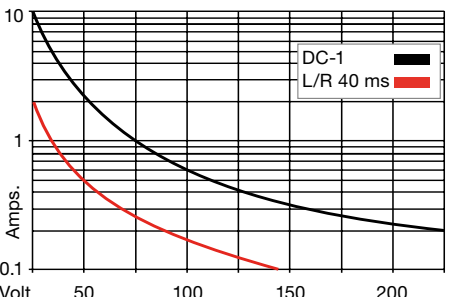
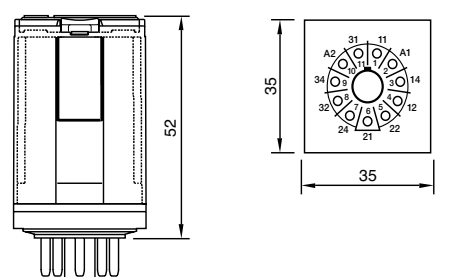


fig. 2 DC load limit curve



Dimensions (mm)



Technical approvals, conformities



C3-T3x

3 pole | changeover twin contact

Maximum contact load	6 A/250 V AC-1	6 A/30 V DC-1
Recommended minimum contact load	5 mA/5 V Code 1 1 mA/5 V Code 2	

Contacts

Material	Standard	Code 1	AgNi + 0.2 μ Au
	Optional	Code 2	AgNi + 5 μ Au
Rated Load	6 A		
Max. inrush current (20 ms)	15 A		
Switching voltage max.	250 V		
AC load fig. 1	1.2 kVA		
DC load	see fig. 2		

Coil

Coil resistance	see table; tolerance ± 10 %
Pick-up voltage	≤ 0.8 x U _N
Release voltage	≥ 0.1 x U _N
Nominal power	2.2 VA (AC)/1.3 W (DC)

Coil table

V AC	Ω	mA	V DC	Ω	mA
24	67	92	24	480	50
48	296	46	48	1K8	26
115	1K7	19	110	9K	12
230	7K1	9.5	220	36K1	6

Insulation

Contact open	1000 V
Contact/contact	2.5 kV
Contact/coil	2.5 kV
Insulation resistance at 500 V	≥1 GΩ
Insulation, EN 61810-1	2.5 kV

Specifications

Ambient temperature operation/storage	-40 ... 70 °C /-40 ... 80 °C (no ice)
Pick-up time/bounce time	8 ms /≤ 3 ms
Release time/bounce time	18 ms /≤ 1 ms
Mechanical life ops	AC: 10 Mill./DC: 20 Mill.
DC voltage endurance at rated load	≥100 000 switching cycles
Max. switching frequency at rated load	1200/h
Weight	81 g

Product References

V AC 50 Hz/60 Hz: 24, 48, 115 (120), 230 (240)

LED

RC Suppressor

V DC 24, 48, 110, 220

LED

Free wheeling diode

Polarity and free wheeling diode

AC/DC bridge rectifier 24 V, 48 V, 60 V

Other voltages on request

"..." List Coil Voltage to complete Product References

Accessories

Socket	S3-B, S3-S, S3-PO, S3-M, S3-M0, S3-M1
Blanking Plug	SO-NP (BAG 10 PCS)



Connection diagram

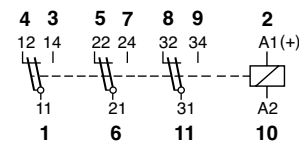


fig. 1 AC voltage endurance

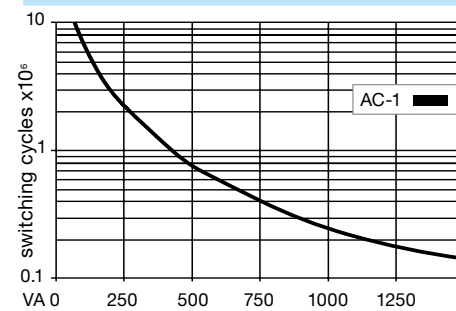
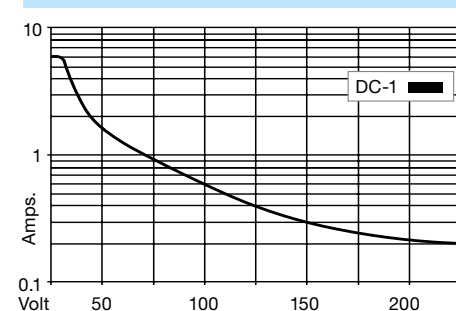
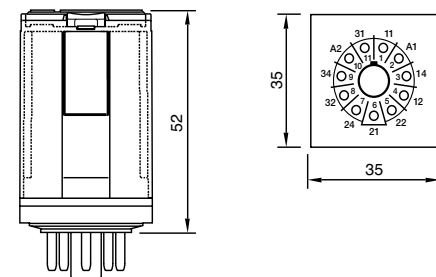


fig. 2 DC load limit curve



Dimensions (mm)



Technical approvals, conformities



IEC/EN 61810; IEC/EN 60947

C3-G3x

3 pole | normally open contact

Maximum contact load	10 A/250 V AC-1	1.2 A/110 V DC-1
Recommended minimum contact load	10 A/30 V DC-1	0.4 A/220 V DC-1

Contacts

Material	Standard	Code 0	AgNi
Rated Load	10 A		
Max. inrush current (20 ms)	30 A		
Switching voltage max.	250 V		
AC load fig. 1	2.5 kVA		
DC load	see fig. 2		

Coil

Coil resistance	see table; tolerance ± 10 %
Pick-up voltage	≤ 0.8 x U _N
Release voltage	≥ 0.1 x U _N
Nominal power	2.4 VA (AC)/1.6 W (DC)

Coil table

V AC	Ω	mA	V DC	Ω	mA
24	65	100	24	360	66
48	286	50	48	1K4	34
115	1K7	21	110	7K6	15
230	6K8	10	220	30K3	7.5

Insulation

Contact open	2000 V
Contact/contact	2.5 kV
Contact/coil	2.5 kV
Insulation resistance at 500 V	≥1 GΩ
Insulation, IEC 61810-1	2.5 kV

Specifications

Ambient temperature operation/storage	-40...60 °C /-40 ... 80 °C (no ice)
Pick-up time/bounce time	20 ms /≤ 3 ms
Release time/bounce time	8 ms /≤ 1 ms
Mechanical life ops	AC: 10 Mill./DC: 20 Mill.
DC voltage endurance at rated load	≥100 000 switching cycles
Max. switching frequency at rated load	1200/h
Weight	81 g

Product References

V AC 50 Hz/60 Hz: 24, 48, 115 (120), 230 (240)

LED

RC Suppressor

V DC 24, 48, 110, 220

LED

Free wheeling diode

Polarity and free wheeling diode

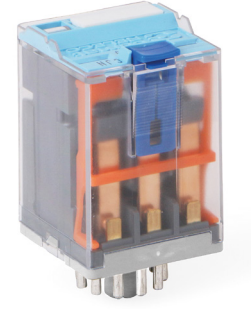
AC/DC bridge rectifier 24 V, 48 V, 60 V

Other voltages on request

"..." List Coil Voltage to complete Product References

Accessories

Socket	S3-B, S3-S, S3-PO, S3-M, S3-M0, S3-M1
Blanking Plug	SO-NP (BAG 10 PCS)



Connection diagram

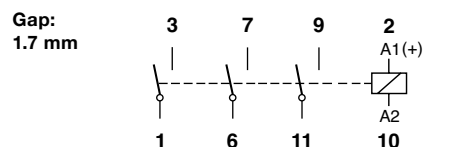


fig. 1 AC voltage endurance

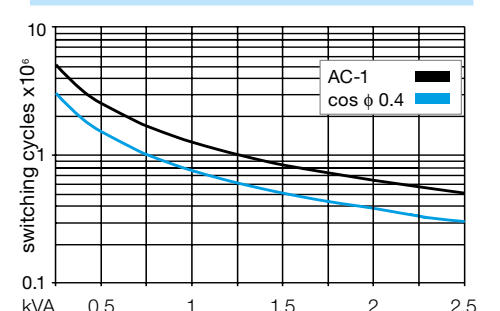
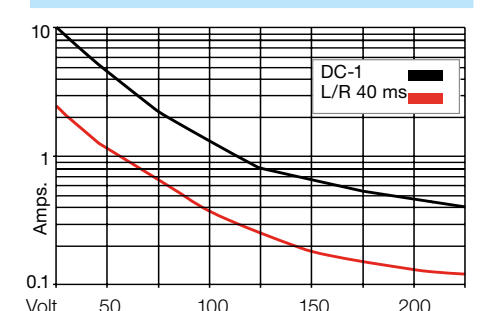
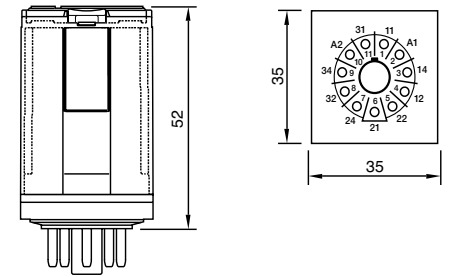


fig. 2 DC load limit curve



Dimensions (mm)



Technical approvals, conformities



IEC/EN 61810; IEC/EN 60947

C3-M1x

1 pole | normally open serial contact with blow magnet

Maximum contact load	10 A /250 V AC-1	10 A/220 V DC-1
-----------------------------	-------------------------	------------------------

Contacts

Material	Standard	Code 0	⚡ AgNi
Rated Load			10 A
Max. inrush current (20 ms)			30 A
Switching voltage max.			250 V
AC load fig. 1			2.5 kVA
DC load			see fig. 2

Coil

Coil resistance	see table; tolerance ± 10 %
Pick-up voltage	≤ 0.8 x U _n
Release voltage	≥ 0.1 x U _n
Nominal power	2.4 VA (AC) / 1.3 W (DC)

Coil table

V AC	Ω	mA	V DC	Ω	mA
24	65	100	24	480	50
48	286	50	48	1K8	26
115	1K7	21	110	9K	12
230	6K8	10	220	29K	7.5

Insulation

Contact open	2500 V
Contact/contact	2.5 kV
Contact/coil	2.5 kV
Insulation resistance at 500 V	≥ 1 GΩ
Insulation, IEC 61810-1:	2.5 kV

Specifications

Ambient temperature operation/storage	-40 ... 70 °C (55° C AC) /-40 ... 80 °C (no ice)
Pick-up time/bounce time	20 ms /≤ 3 ms
Release time/bounce time	10 ms /≤ 1 ms
Mechanical life ops	AC: 10 Mill./DC: 20 Mill.
DC voltage endurance at rated load	≥ 100 000 switching cycles
Max. switching frequency at rated load	1200/h
Weight	90 g

Product References

V AC 50 Hz/60 Hz: 24, 48, 115 (120), 230 (240)
LED
RC Suppressor

C3-M10/AC ... V
C3-M10X/AC ... V
C3-M10R/AC ... V

V DC 24, 48, 110, 220

LED
Free wheeling diode
Polarity and free wheeling diode

C3-M10/DC ... V
C3-M10X/DC ... V
C3-M10DX/DC ... V
C3-M10FX/DC ... V

AC/DC bridge rectifier 24 V, 48 V, 60 V

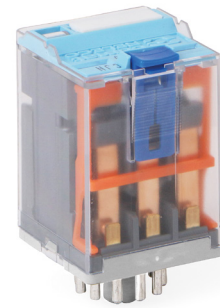
Other voltages on request

C3-M10BX/UC ... V

"..." List Coil Voltage to complete Product References

Accessories

Socket **S3-B, S3-S, S3-PO, S3-M, S3-M0, S3-M1**
 Blanking Plug **SO-NP (BAG 10 PCS)**



Connection diagram

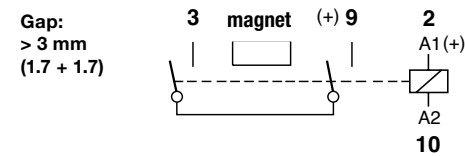


fig. 1 AC voltage endurance

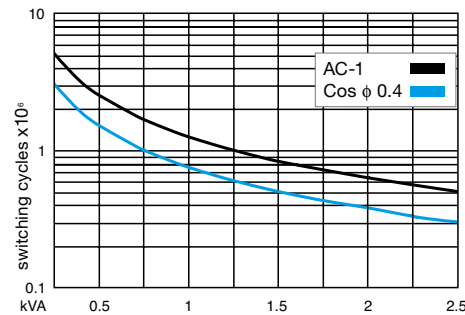
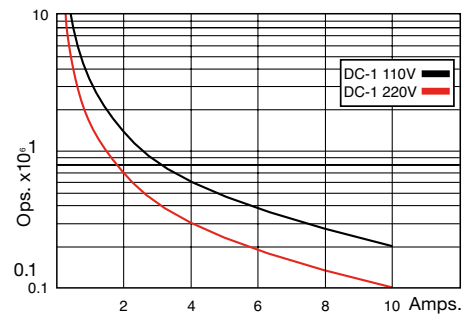
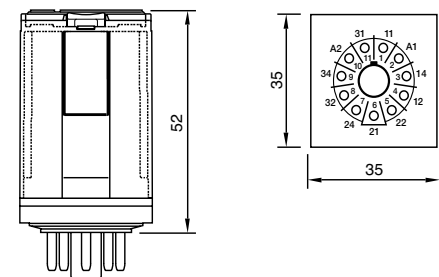


fig. 2 DC voltage endurance



Dimensions (mm)



Technical approvals, conformities



C3-X1x

1 pole | normally open serial contact

Maximum contact load	10 A/250 V AC-1	7 A/110 V DC-1
	10 A/30 V DC-1	1.2 A/220 V DC-1

Contacts

Material	Standard	Code 0	⚡ AgNi
Rated Load			10 A
Max. inrush current (20 ms)			30 A
Switching voltage max.			250 V
AC load fig. 1			2.5 kVA
DC load			see fig. 2

Coil

Coil resistance	see table; tolerance ± 10 %
Pick-up voltage	≤ 0.8 x U _n
Release voltage	≥ 0.1 x U _n
Nominal power	2.4 VA (AC)/1.3 W (DC)

Coil table

V AC	Ω	mA	V DC	Ω	mA
24	65	100	24	480	54
48	286	50	48	1K8	26
115	1K7	21	110	9K	12
230	6K8	10	220	29K	7.5

Insulation

Contact open	2500 V
Contact/contact	2.5 kV
Contact/coil	2.5 kV
Insulation resistance at 500 V	≥ 1 GΩ
Insulation, IEC 61810-1:	2.5 kV

Specifications

Ambient temperature operation/storage	-40...60 °C /-40 ... 80 °C (no ice)
Pick-up time/bounce time	18 ms /≤ 3 ms
Release time/bounce time	8 ms /≤ 1 ms
Mechanical life ops	AC: 10 Mill./DC: 20 Mill.
DC voltage endurance at rated load	≥ 100 000 switching cycles
Max. switching frequency at rated load	1200/h
Weight	83 g

Product References

V AC 50 Hz/60 Hz: 24, 48, 115 (120), 230 (240)
LED
RC Suppressor

C3-X10/AC ... V
C3-X10X/AC ... V
C3-X10R/AC ... V

V DC 24, 48, 110, 220

LED
Free wheeling diode
Polarity and free wheeling diode

C3-X10/DC ... V
C3-X10X/DC ... V
C3-X10DX/DC ... V
C3-X10FX/DC ... V

AC/DC bridge rectifier 24 V, 48 V, 60 V

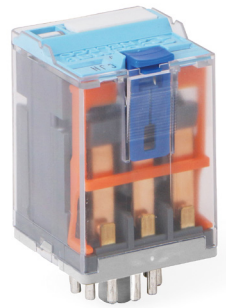
Other voltages on request

C3-X10BX/UC ... V

"..." List Coil Voltage to complete Product References

Accessories

Socket **S3-B, S3-S, S3-PO, S3-M, S3-M0, S3-M1**
 Blanking Plug **SO-NP (BAG 10 PCS)**



Connection diagram

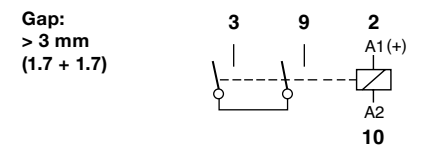


fig. 1 AC voltage endurance

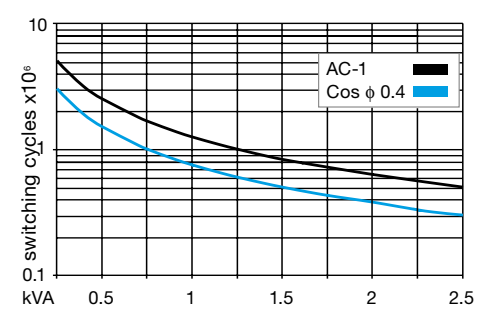
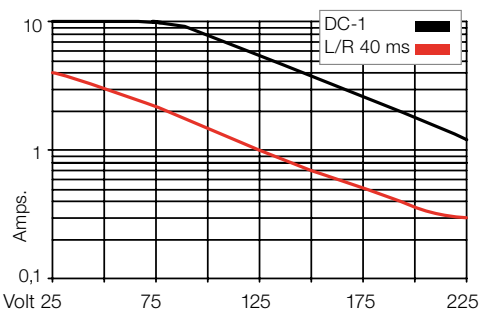
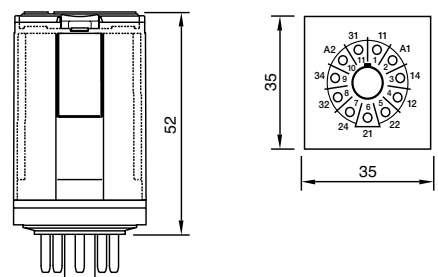


fig. 2 DC load limit curve



Dimensions (mm)



Technical approvals, conformities



C3-R2x

2 pole | changeover contact | remanance

Maximum contact load	10 A/250 V AC-1	0.5 A/110 V DC-1
	10 A/30 V DC-1	0.2 A/220 V DC-1
Recommended minimum contact load	10 mA/10 V Code 0	
	5 mA/5 V Code 8	

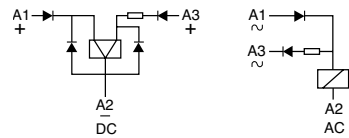
Contacts

Material	Standard	Code 0	⚡ AgNi
	Optional	Code 8	⚡ AgNi + 5 μ Au
Rated Load	10 A		
Max. inrush current (20 ms)	30 A		
Switching voltage max.	250 V		
AC load fig. 1	2.5 kVA		
DC load	see fig. 2		

Coil

Coil resistance	see table; tolerance ± 10 %
ON pulse power	1.5 VA/W
OFF pulse power	0.5 VA/W
Pull-in ON OFF	≤ 0.8 x U _N

Internal Diagram:



Coil table

V AC	mA ON	mA OFF	V DC	mA ON	mA OFF
24	75	12	12	125	41
48	38	6	24	63	21
115	16	2.5	48	31	10
230	8	1.3	110	14	4.5

Insulation

Contact open	1000 V
Contact/contact	2.5 kV
Contact/coil	2.5 kV
Insulation resistance at 500 V	≥ 1 GΩ
Insulation, IEC 61810-1	2.5 kV

Specifications

Ambient temperature operation/storage	-40...60 °C / -40 ... 80 °C (no ice)
Minimum pulse length for ON OFF	50 ms
Mechanical life ops	10 Mill.
DC voltage endurance at rated load	≥ 100 000 switching cycles
Max. switching frequency at rated load	1200/h
Weight	81 g

Product References

V AC 50 Hz/60 Hz: 24, 48, 115, 230

C3-R20N/AC ... V C3-R28N/AC ... V

V DC 12, 24, 48, 110

C3-R20N/DC ... V C3-R28N/DC ... V

Other voltages on request

"..." List Coil Voltage to complete Product References

Accessories

Socket	S3-B, S3-S, S3-PO, S3-M, S3-M0, S3-M1
Blanking Plug	SO-NP (BAG 10 PCS)



Connection diagram

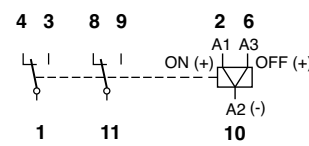


fig. 1 AC voltage endurance

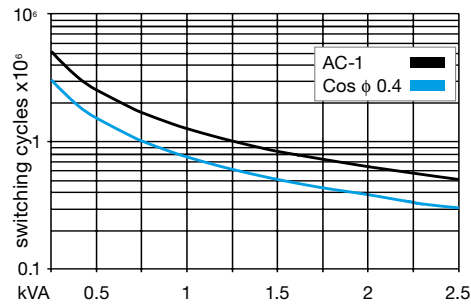
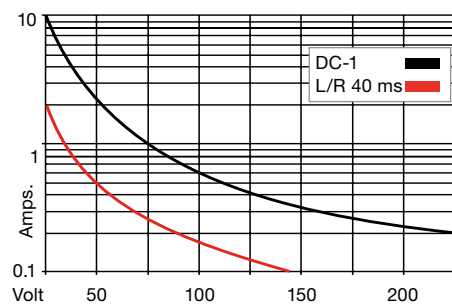
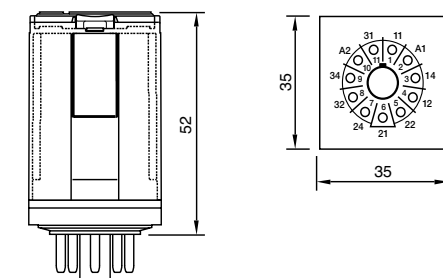


fig. 2 DC load limit curve



Dimensions (mm)



Technical approvals, conformities



C3-N3x

3 pole | changeover contact | sensitive coil

Maximum contact load	6 A/250 V AC-1	6 A/30 V DC-1
Recommended minimum contact load	10 mA/10 V Code 4	
	5 mA/5 V Code 8	

Contacts

Material	Standard	Code 4	⚡ AgNi + 0.2 μ Au
	Optional	Code 8	⚡ AgNi + 5 μ Au
Rated Load	5 A		
Max. inrush current (20 ms)	30 A		
Switching voltage max.	250 V		
AC load fig. 1	1.5 kVA		
DC load	see fig. 2		

Coil

Coil resistance	see table; tolerance ± 10 %
Pick-up voltage	≤ 0.8 x U _N
Release voltage	≥ 0.1 x U _N
Nominal power	800 mW

Coil table

V AC	Ω	mA	V DC	Ω	mA
24	67	92	24	480	50
48	296	46	48	1K8	26
115	1K7	19	110	9K	12
230	7K1	9.5	220	36K1	6

Insulation

Contact open	1000 V
Contact/contact	2.5 kV
Contact/coil	2.5 kV
Insulation resistance at 500 V	≥ 1 GΩ
Insulation, IEC 61810-1	2.5 kV

Specifications

Ambient temperature operation/storage	-40...60 °C / -40 ... 80 °C (no ice)
Pick-up time/bounce time	18 ms / ≤ 3 ms
Release time/bounce time	10 ms / ≤ 1 ms
Mechanical life ops	DC: 20 Mill.
DC voltage endurance at rated load	≥ 100 000 switching cycles
Max. switching frequency at rated load	1200/h
Weight	90 g

Product References

V DC 24, 48, 60, 110

Free wheeling diode

Polarity and free wheeling diode

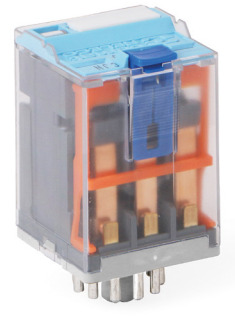
Other voltages on request

C3-N34/DC ... V C3-N38/DC ... V
C3-N34D/DC ... V C3-N38D/DC ... V
C3-N34F/DC ... V C3-N38F/DC ... V

"..." List Coil Voltage to complete Product References

Accessories

Socket	S3-B, S3-S, S3-PO, S3-M, S3-M0, S3-M1
Blanking Plug	SO-NP (BAG 10 PCS)



Connection diagram

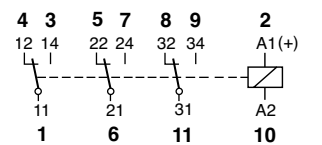


fig. 1 AC voltage endurance

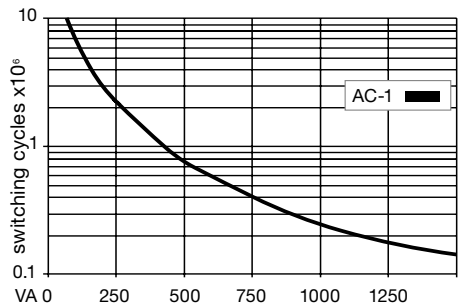
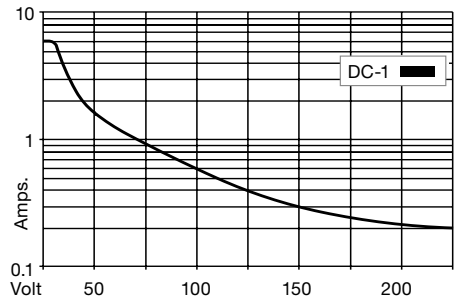
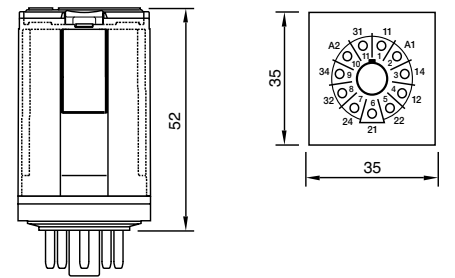


fig. 2 DC load limit curve



Dimensions (mm)



Technical approvals, conformities



C4-A4x

4 pole | changeover contact | Faston

Maximum contact load	10 A/250 V AC-1	0.5 A/110 V DC-1
	10 A/30 V DC-1	0.2 A/220 V DC-1
Recommended minimum contact load	10 mA/5 V Code 0	
	5 mA/5 V Code 8	

Contacts

Material	Standard	Code 0	⚡ AgNi
	Optional	Code 8	⚡ AgNi + 5 μ Au
Rated Load	10 A		
Max. inrush current (20 ms)	30 A		
Switching voltage max.	250 V		
AC load fig. 1	2.5 kVA		
DC load	see fig. 2		

Coil

Coil resistance	see table; tolerance ± 10 %
Pick-up voltage	≤ 0.8 x U _N
Release voltage	≥ 0.1 x U _N
Nominal power	2.4 VA (AC)/1.4 W (DC)

Coil table

V AC	Ω	mA	V DC	Ω	mA
24	65	100	24	414	58
48	286	50	48	1K6	30
115	1K7	21	110	8K1	13
-	-	-	120-125	10K	12.3
230	6K8	10	220	35K7	6.2

Insulation

Contact open	1000 V
Contact/contact	2.5 kV
Contact/coil	2.5 kV
Insulation resistance at 500 V	≥ 1 GΩ
Insulation, IEC 61810-1	2.5 kV

Specifications

Ambient temperature operation/storage	-40...60 °C / -40 ... 80 °C (no ice)
Pick-up time/bounce time	20 ms / ≤ 3 ms
Release time/bounce time	8 ms / ≤ 1 ms
Mechanical life ops	AC: 10 Mill./DC: 20 Mill.
DC voltage endurance at rated load	≥ 100 000 switching cycles
Max. switching frequency at rated load	1200/h
Weight	90 g

Product References

V AC 50 Hz/60 Hz: 24, 48, 115, (120), 230, (240)

LED

RC Suppressor

V DC 24, 48, 110, 220

LED

Free wheeling diode

Polarity and free wheeling diode

AC/DC bridge rectifier 24 V, 48 V, 60 V

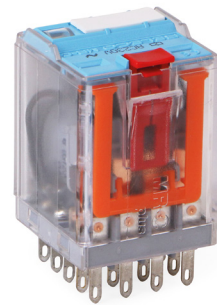
Other voltages on request

"..." List Coil Voltage to complete Product References

Accessories

- Socket
- Wall Mounting Adapter
- Blanking Plug

- S4-J, S4-L, S4-P
- S5-R (BAG 5 PCS)
- SO-NP (BAG 10 PCS)



Connection diagram

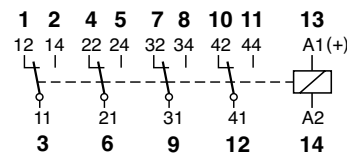


fig. 1 AC voltage endurance

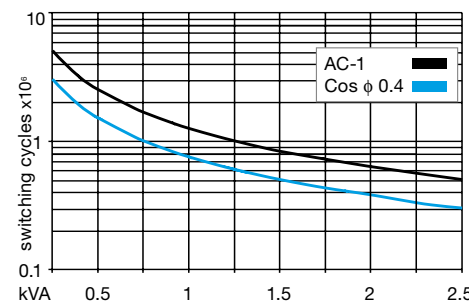
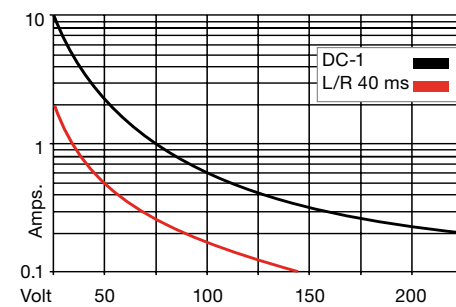
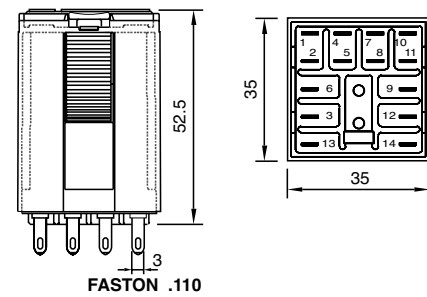


fig. 2 DC load limit curve



Dimensions (mm)



Technical approvals, conformities



C4-X2x

2 pole | normally open serial contact | Faston

Maximum contact load	10 A/250 V AC-1	7 A/110 V DC-1
	10 A/30 V DC-1	1.2 A/220 V DC-1
Recommended minimum contact load	10 mA/10 V Code 0	

Contacts

Material	Standard	Code 0	⚡ AgNi
Rated Load	10 A		
Max. inrush current (20 ms)	30 A		
Switching voltage max.	250 V		
AC load fig. 1	2.5 kVA		
DC load	see fig. 2		

Coil

Coil resistance	see table; tolerance ± 10 %
Pick-up voltage	≤ 0.8 x U _N
Release voltage	≥ 0.1 x U _N
Nominal power	2.4 VA (AC)/1.3 W (DC)

Coil table

V AC	Ω	mA	V DC	Ω	mA
24	65	100	24	443	54
48	286	50	48	1K8	27
115	1K7	21	110	9K2	12
230	6k8	10	220	30K3	6

Insulation

Contact open	2500 V
Contact/contact	2.5 kV
Contact/coil	2.5 kV
Insulation resistance at 500 V	≥ 1 GΩ
Insulation, IEC 61810-1	2.5 kV

Specifications

Ambient temperature operation/storage	-40...60 °C / -40 ... 80 °C (no ice)
Pick-up time/bounce time	20 ms / ≤ 3 ms
Release time/bounce time	8 ms / ≤ 1 ms
Mechanical life ops	AC: 10 Mill./DC: 20 Mill.
DC voltage endurance at rated load	≥ 100 000 switching cycles
Max. switching frequency at rated load	1200/h
Weight	90 g

Product References

V AC 50 Hz/60 Hz: 24, 48, 115, (120), 230, (240)

LED

RC Suppressor

V DC 24, 48, 110, 220

LED

Free wheeling diode

Polarity and free wheeling diode

AC/DC bridge rectifier 24 V, 48 V, 60 V

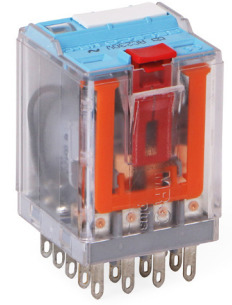
Other voltages on request

"..." List Coil Voltage to complete Product References

Accessories

- Socket
- Wall Mounting Adapter
- Blanking Plug

- S4-J, S4-L, S4-P
- S5-R (BAG 5 PCS)
- SO-NP (BAG 10 PCS)



Connection diagram

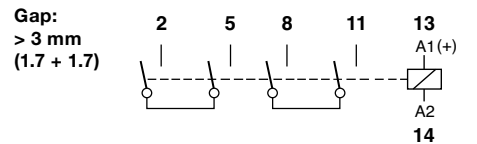


fig. 1 AC voltage endurance

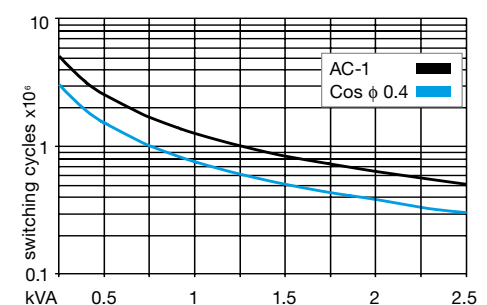
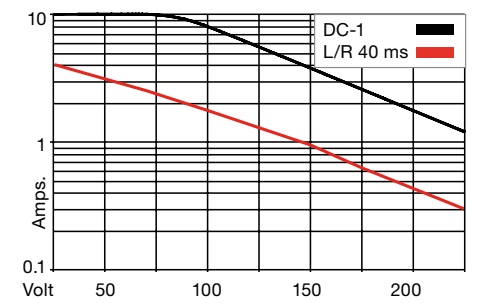
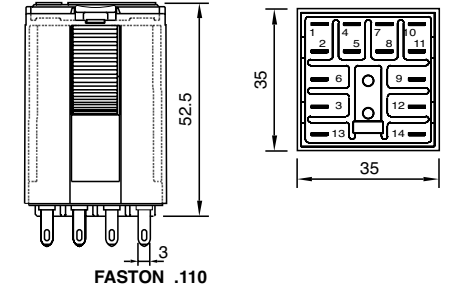


fig. 2 DC load limit curve



Dimensions (mm)



Technical approvals, conformities



C4-R3x

3 pole | changeover contact | remanance

Maximum contact load	10 A/250 V AC-1	0.5 A/110 V DC-1
	10 A/10 V DC-1	0.2 A/220 V DC-1
Recommended minimum contact load	10 mA/10 V Code 0	
	5 mA/5 V Code 8	

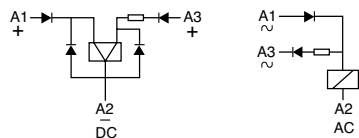
Contacts

Material	Standard	Code 0	⚡ AgNi
	Optional	Code 8	⚡ AgNi + 5 μ Au
Rated Load	10 A		
Max. inrush current (20 ms)	30 A		
Switching voltage max.	250 V		
AC load fig. 1	2.5 kVA		
DC load	see fig. 2		

Coil

Coil resistance	see table; tolerance ± 10 %
ON pulse power	1.5 VA/W
OFF pulse power	0.5 VA/W
Pull-in ON OFF	1 Winding for AC, 2 Windings for DC ≤ 0.8 x U _N

Internal Diagram:



Coil table

V AC	mA ON	mA OFF	V DC	mA ON	mA OFF
24	75	12	12	125	41
48	38	6	24	63	21
115	16	2.5	48	31	10
230	8	1.3	110	14	4.5

Insulation

Contact open	1000 V
Contact/contact	2.5 kV
Contact/coil	2.5 kV
Insulation resistance at 500 V	≥ 1 GΩ
Insulation, IEC 61810-1	2.5 kV

Specifications

Ambient temperature operation/storage	-40...60 °C / -40 ... 80 °C (no ice)
Minimum pulse length for ON OFF	50 ms
Mechanical life ops	AC: 10 Mill./DC: 20 Mill. switching cycles
DC voltage endurance at rated load	≥ 100 000 switching cycles
Max. switching frequency at rated load	1200/h
Weight	95 g

Product References

V AC 50 Hz/60 Hz: 24, 48, 115, 230

C4-R30/AC ... V C4-R38/AC ... V

V DC 12, 24, 48, 110

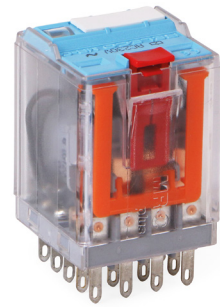
Other voltages on request

C4-R30/DC ... V C4-R38/DC ... V

"..." List Coil Voltage to complete Product References

Accessories

- Socket **S4-J, S4-L, S4-P**
- Wall Mounting Adapter **S5-R (BAG 5 PCS)**
- Blanking Plug **SO-NP (BAG 10 PCS)**



Connection diagram

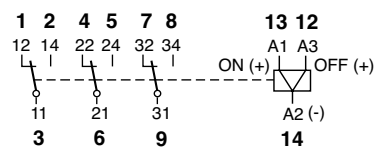


fig. 1 AC voltage endurance

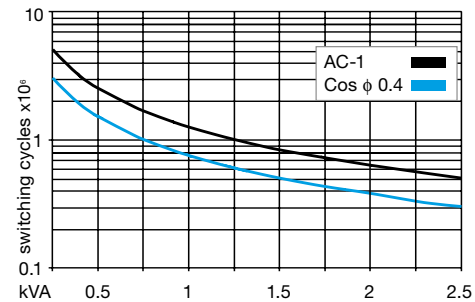
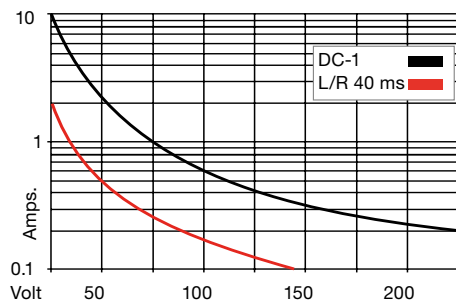
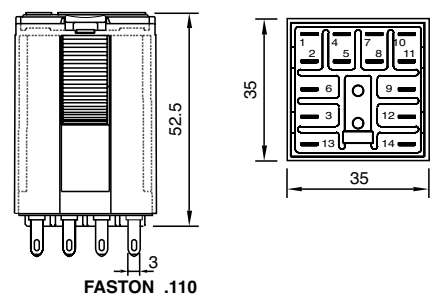


fig. 2 DC load limit curve



Dimensions (mm)



Technical approvals, conformities



C5-A2x

2 pole | changeover contact | Faston

Maximum contact load	16 A/400 V AC-1	0.5 A/110 V DC-1
	16 A/30 V DC-1	0.2 A/220 V DC-1
Recommended minimum contact load	10mA/10V	

Contacts

Material	Standard	Code 0	⚡ AgNi
Rated Load	16 A		
Max. inrush current (20 ms)	40 A		
Switching voltage max.	400 V		
AC load fig. 1	4 kVA		
DC load	see fig. 2		

Coil

Coil resistance	see table; tolerance ± 10 %
Pick-up voltage	≤ 0.8 x U _N
Release voltage	≥ 0.1 x U _N
Nominal power	2.4 VA (AC)/1.4 W (DC)

Coil table

V AC	Ω	mA	V DC	Ω	mA
24	65	100	24	414	58
48	286	50	48	1K6	30
115	1K7	21	110	8K1	13
230	6K8	10	220	30K3	6

Insulation

Contact open	1000 V
Contact/contact	4 kV
Contact/coil	4 kV
Insulation resistance at 500 V	≥ 3 GΩ
Insulation, IEC 61810-1	4 kV

Specifications

Ambient temperature operation/storage	-40...60 °C / -40 ... 80 °C (no ice)
Pick-up time/bounce time	20 ms / ≤ 3 ms
Release time/bounce time	10 ms / ≤ 1 ms
Mechanical life ops	AC: 10 Mill./DC: 20 Mill.
DC voltage endurance at rated load	≥ 100 000 switching cycles
Max. switching frequency at rated load	1200/h
Weight	90 g

Product References

V AC 50 Hz/60 Hz: 24, 48, 115 (120), 230 (240)

LED

RC Suppressor (max 250 V)

V DC 24, 48, 110, 220

LED

Free wheeling diode

Polarity and free wheeling diode

AC/DC bridge rectifier 24 V, 48 V, 60 V

Other voltages on request

"..." List Coil Voltage to complete Product References

Accessories

- Socket **S5-M, S5-P**
- Wall Mounting Adapter **S5-R (BAG 5 PCS)**
- Blanking Plug **SO-NP (BAG 10 PCS)**



Connection diagram

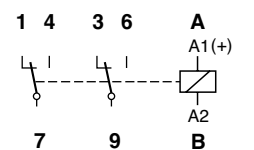


fig. 1 AC voltage endurance

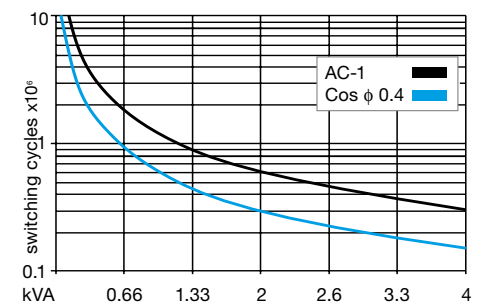
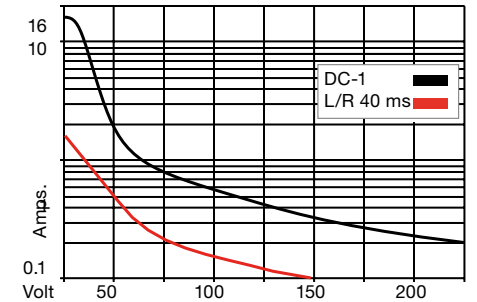
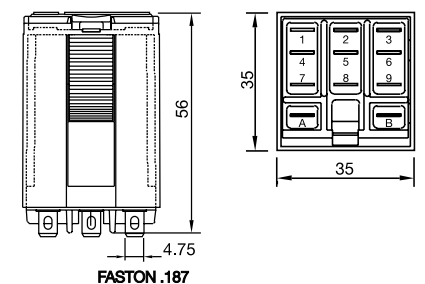


fig. 2 DC load limit curve



Dimensions (mm)



Technical approvals, conformities



C5-A3x

3 pole | changeover contact | Faston

Maximum contact load	16 A/400 V AC-1	0.5 A/110 V DC-1
	16 A/30 V DC-1	0.2 A/220 V DC-1
Recommended minimum contact load	10mA/10V	

Contacts

Material	Standard	Code 0	⚡ AgNi
	Optional	Code 5	⚡ AgSnO ₂
Rated Load	16 A		
Max. inrush current (20 ms)	40 A		
Switching voltage max.	400 V		
AC load fig. 1	4 kVA		
DC load	see fig. 2		

Coil

Coil resistance	see table; tolerance ± 10 %
Pick-up voltage	≤ 0.8 x U _N
Release voltage	≥ 0.1 x U _N
Nominal power	2.4 VA (AC)/1.4 W (DC)

Coil table

V AC	Ω	mA	V DC	Ω	mA
24	65	100	24	414	58
48	286	50	48	1K6	30
115	1K7	21	110	8K1	13
230	6K8	10	220	30K3	6.2
400	18K8	6			

Insulation

Contact open	1000 V
Contact/contact	4 kV
Contact/coil	4 kV
Insulation resistance at 500 V	≥ 3 GΩ
Insulation, IEC 61810-1	4 kV

Specifications

Ambient temperature operation/storage	-40...60 °C / -40 ... 80 °C (no ice)
Pick-up time/bounce time	20 ms / ≤ 3 ms
Release time/bounce time	10 ms / ≤ 1 ms
Mechanical life ops	AC: 10 Mill./DC: 20 Mill.
DC voltage endurance at rated load	≥ 100 000 switching cycles
Max. switching frequency at rated load	1200/h
Weight	95 g

Product References

V AC 50 Hz/60 Hz: 24, 48, 115, (120), 230, (240)
 LED
 RC Suppressor (max 250 V)

C5-A30/AC ... V
 C5-A30X/AC ... V
 C5-A30R/AC ... V

C5-A35/AC ... V
 C5-A35X/AC ... V
 C5-A35R/AC ... V

V DC 24, 48, 110, 220

LED
 Free wheeling diode
 Polarity and free wheeling diode

C5-A30/DC ... V
 C5-A30X/DC ... V
 C5-A30DX/DC ... V
 C5-A30FX/DC ... V

C5-A35/DC ... V
 C5-A35X/DC ... V
 C5-A35DX/DC ... V
 C5-A35FX/DC ... V

AC/DC bridge rectifier 24 V, 48 V, 60 V

C5-A30BX/UC ... V

C5-A35BX/UC ... V

Other voltages on request

"..." List Coil Voltage to complete Product References

Accessories

Socket
 Wall Mounting Adapter
 Blanking Plug

S5-M, S5-P
 S5-R (BAG 5 PCS)
 SO-NP (BAG 10 PCS)



Connection diagram

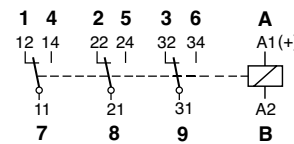


fig. 1 AC voltage endurance

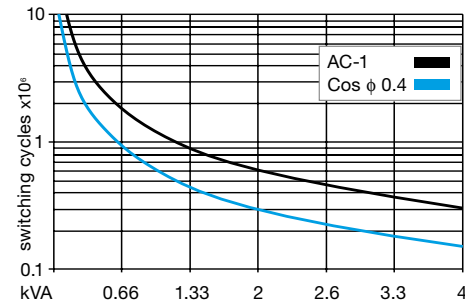
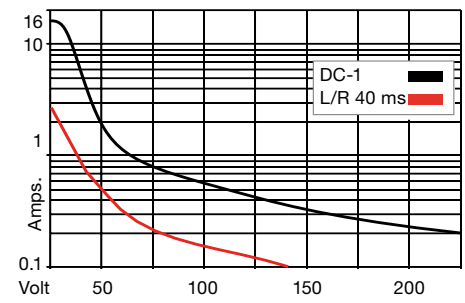
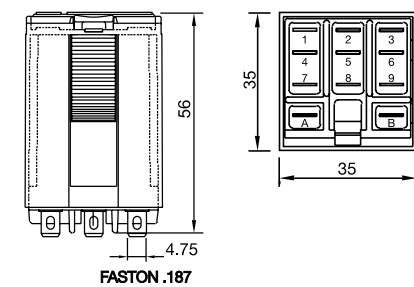


fig. 2 DC load limit curve



Dimensions (mm)



Technical approvals, conformities



C5-G3x

3 pole | normally open contact | Faston

Maximum contact load	16 A/400 V AC-1	1.2 A/110 V DC-1
	16 A/30 V DC-1	0.4 A/220 V DC-1
Recommended minimum contact load	10mA/10V	

Contacts

Material	Standard	Code 0	⚡ AgNi
	Optional	Code 5	⚡ AgSnO ₂
Rated Load	16 A		
Max. inrush current (20 ms)	40 A		
Switching voltage max.	400 V		
AC load fig. 1	4 kVA		
DC load	see fig. 2		

Coil

Coil resistance	see table; tolerance ± 10 %
Pick-up voltage	≤ 0.8 x U _N
Release voltage	≥ 0.1 x U _N
Nominal power	2.4 VA (AC)/1.6 W (DC)

Coil table

V AC	Ω	mA	V DC	Ω	mA
24	65	100	12	90	133
48	286	50	24	373	66
115	1K7	21	48	1K4	34
230	6K8	10	110	7K6	15
400	18K8	6	220	30K3	7.5

Insulation

Contact open	2000 V
Contact/contact	4 kV
Contact/coil	4 kV
Insulation resistance at 500 V	≥ 3 GΩ
Insulation, IEC 61810-1	4 kV

Specifications

Ambient temperature operation/storage	-40...60 °C / -40 ... 80 °C (no ice)
Pick-up time/bounce time	20 ms / ≤ 3 ms
Release time/bounce time	10 ms / ≤ 1 ms
Mechanical life ops	AC: 10 Mill./DC: 20 Mill.
DC voltage endurance at rated load	≥ 100 000 switching cycles
Max. switching frequency at rated load	1200/h
Weight	95 g

Product References

V AC 50 Hz/60 Hz: 24, 48, 115, (120), 230, (240)
 LED
 RC Suppressor (max 250 V)

C5-G30/AC ... V
 C5-G30X/AC ... V
 C5-G30R/AC ... V

C5-G35/AC ... V
 C5-G35X/AC ... V
 C5-G35R/AC ... V

V DC 12, 24, 48, 110, 220

LED
 Free wheeling diode
 Polarity and free wheeling diode

C5-G30/DC ... V
 C5-G30X/DC ... V
 C5-G30DX/DC ... V
 C5-G30FX/DC ... V

C5-G35/DC ... V
 C5-G35X/DC ... V
 C5-G35DX/DC ... V
 C5-G35FX/DC ... V

AC/DC bridge rectifier 24 V, 48 V, 60 V

C5-G30BX/UC ... V

C5-G35BX/UC ... V

Other voltages on request

"..." List Coil Voltage to complete Product References

Accessories

Socket
 Wall Mounting Adapter
 Blanking Plug

S5-M, S5-P
 S5-R (BAG 5 PCS)
 SO-NP (BAG 10 PCS)



Connection diagram

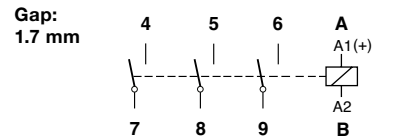


fig. 1 AC voltage endurance

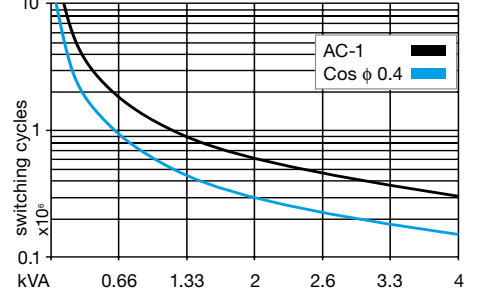
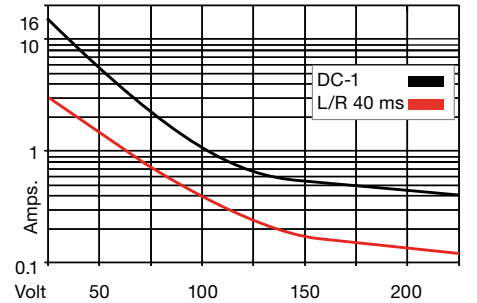
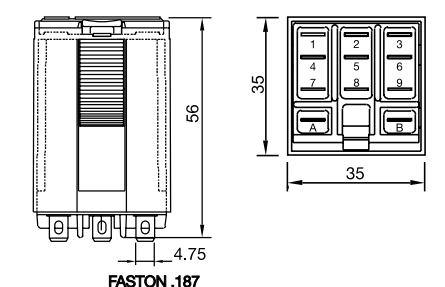


fig. 2 DC load limit curve



Dimensions (mm)



Technical approvals, conformities



C5-X1x

1 pole | normally open serial contact | Faston

Maximum contact load	16 A/400 V AC-1	7 A/110 V DC-1
	16 A/30 V DC-1	1.2 A/220V DC-13
Recommended minimum contact load	10mA/10V	

Contacts

Material	Standard	Code 0	⚡ AgNi
Rated Load	16 A		
Max. inrush current (20 ms)	40 A		
Switching voltage max.	400 V		
AC load fig. 1	4 kVA		
DC load	see fig. 2		

Coil

Coil resistance	see table; tolerance ± 10 %
Pick-up voltage	≤ 0.8 x U _N
Release voltage	≥ 0.1 x U _N
Nominal power	2.4 VA (AC)/1.3 W (DC)

Coil table

V AC	Ω	mA	V DC	Ω	mA
24	65	100	12	110	108
48	286	50	24	443	54
115	1K7	21	48	1K7	27
230	6K8	10	110	9K2	12
400	18K8	6	220	30K3	6.2

Insulation

Contact open	4 kV
Contact/contact	4 kV
Contact/coil	4 kV
Insulation resistance at 500 V	≥ 3 GΩ
Insulation, IEC 61810-1	4 kV

Specifications

Ambient temperature operation/storage	-40...60 °C / -40 ... 80 °C (no ice)
Pick-up time/bounce time	20 ms / ≤ 3 ms
Release time/bounce time	10 ms / ≤ 1 ms
Mechanical life ops	AC: 10 Mill./DC: 20 Mill.
DC voltage endurance at rated load	≥ 100 000 switching cycles
Max. switching frequency at rated load	1200/h
Weight	90 g

Product References

V AC 50 Hz/60 Hz: 24, 48, 115 (120), 230 (240)
LED
RC Suppressor (max 250 V)

C5-X10/AC ... V
C5-X10X/AC ... V
C5-X10R/AC ... V

V DC 12, 24, 48, 110, 220

LED
Free wheeling diode
Polarity and free wheeling diode

C5-X10/DC ... V
C5-X10X/DC ... V
C5-X10DX/DC ... V
C5-X10FX/DC ... V

AC/DC bridge rectifier 24 V, 48 V, 60 V

Other voltages on request

C5-X10BX/UC ... V

"..." List Coil Voltage to complete Product References

Accessories

Socket
 Wall Mounting Adapter
 Blanking Plug

S5-M, S5-P
S5-R (BAG 5 PCS)
SO-NP (BAG 10 PCS)



Connection diagram

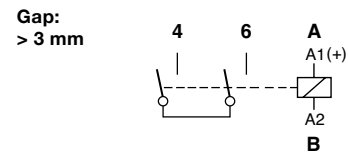


fig. 1 AC voltage endurance

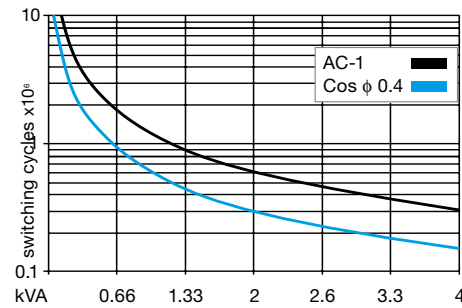
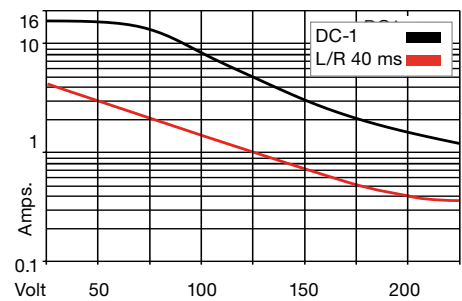
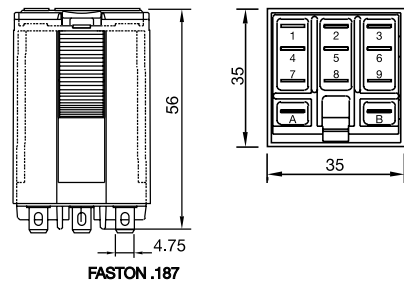


fig. 2 DC load limit curve



Dimensions (mm)



Technical approvals, conformities



IEC/EN 61810; IEC/EN 60947

C5-M1x

1 pole | normally open serial contact with blow magnet | Faston

Maximum contact load	16 A/400 V AC-1	10 A/220 V DC-1
	3.6 A/110 V DC-13	2 A/220 V DC-13
Recommended minimum contact load	10mA/10V	

Contacts

Material	Standard	Code 0	⚡ AgNi
Rated Load	16 A		
Max. inrush current (20 ms)	40 A		
Switching voltage max.	400 V		
AC load fig. 1	4 kVA		
DC load	see fig. 2		

Coil

Coil resistance	see table; tolerance ± 10 %
Pick-up voltage	≤ 0.8 x U _N
Release voltage	≥ 0.1 x U _N
Nominal power	2.4 VA (AC)/1.3 W (DC)

Coil table

V AC	Ω	mA	V DC	Ω	mA
24	65	100	12	110	108
48	286	50	24	443	54
115	1K7	21	48	1K7	27
230	6K8	10	110	9K2	12
400	18K8	6	220	30K3	6.2

Insulation

Contact open	4000 V
Contact/contact	4 kV
Contact/coil	4 kV
Insulation resistance at 500 V	≥ 3 GΩ
Insulation, IEC 61810-1	4 kV

Specifications

Ambient temperature operation/storage	-40...60 °C / -40 ... 80 °C (no ice)
Pick-up time/bounce time	20 ms / ≤ 3 ms
Release time/bounce time	10 ms / ≤ 1 ms
Mechanical life ops	AC: 10 Mill./DC: 20 Mill.
DC voltage endurance	see fig. 2
Max. switching frequency at rated load	1200/h
Weight	90 g

Product References

V AC 50 Hz/60 Hz: 24, 48, 115 (120), 230 (240)
LED
RC Suppressor (max 250 V)

C5-M10/AC ... V
C5-M10X/AC ... V
C5-M10R/AC ... V

V DC 12, 24, 48, 110, 220

LED
Free wheeling diode
Polarity and free wheeling diode

C5-M10/DC ... V
C5-M10X/DC ... V
C5-M10DX/DC ... V
C5-M10FX/DC ... V

AC/DC bridge rectifier 24 V, 48 V, 60 V

Other voltages on request

C5-M10BX/UC ... V

"..." List Coil Voltage to complete Product References

Accessories

Socket
 Wall Mounting Adapter
 Blanking Plug

S5-M, S5-P
S5-R (BAG 5 PCS)
SO-NP (BAG 10 PCS)



Connection diagram

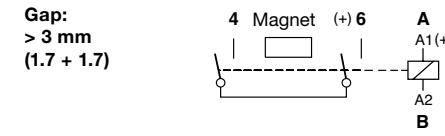


fig. 1 AC voltage endurance

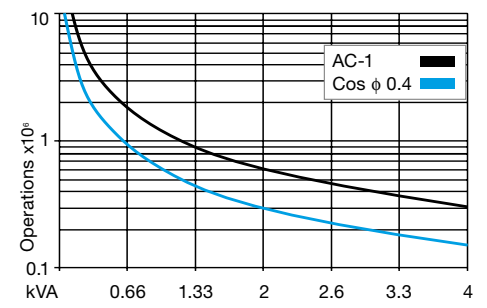
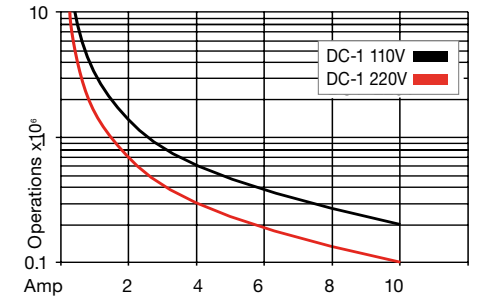
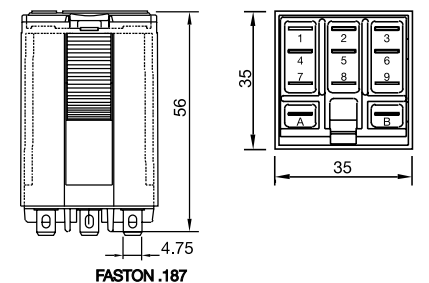


fig. 2 DC voltage endurance



Dimensions (mm)



Technical approvals, conformities



IEC/EN 61810; IEC/EN 60947

C5-M2x

2 pole | normally open contact with blow magnet | Faston

Maximum contact load	16 A / 250 V AC-1	7 A / 110 V DC-1
		3 A / 220 V DC-1
Recommended minimum contact load	10mA/10V	

Contacts	
Material	Standard Code 0 AgNi
Rated Load	16 A
Max. inrush current (20 ms)	40 A
Switching voltage max.	250 V
AC load fig. 1	4 kVA
DC load	see fig. 2

Coil	
Coil resistance	see table; tolerance ± 10 %
Pick-up voltage	≥ 0.8 x U _N
Release voltage	≥ 0.1 x U _N
Nominal power	2.4 VA (AC) / 1.6 W (DC)

Coil table					
V AC	Ω	mA	V DC	Ω	mA
24	65	100	12	90	133
48	286	50	24	373	66
115	1K7	21	48	1K4	33
230	6K8	10.4	110	7K6	15

Insulation	
Contact open	2 kV
Contact/contact	4 kV
Contact/coil	3 kV
Insulation resistance at 500 V	≥ 3 GΩ
Insulation, EN 60947/IEC 61810-1:	4 kV

Specifications	
Ambient temperature operation/storage	-40...60 °C / -40 ... 80 °C (no ice)
Pick-up time/bounce time	20 ms / ≤ 3 ms
Release time/bounce time	10 ms / ≤ 1 ms
Mechanical life ops	AC: 10 Mill./DC: 20 Mill. switching cycles
DC Rated load	≥ 75 000 switching cycles
Max. switching frequency at rated load	1200/h
Weight	90 g

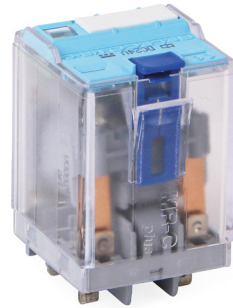
Product References	
V AC 50 Hz/60 Hz: 24, 48, 115 (120), 230 (240)	C5-M20/AC ... V
LED	C5-M20X/AC ... V
RC Suppressor	C5-M20R/AC ... V

V DC 12, 24, 48, 110, 220	C5-M20/DC ... V
LED	C5-M20X/DC ... V
Free wheeling diode	C5-M20DX/DC ... V
Polarity and free wheeling diode	C5-M20FX/DC ... V

AC/DC bridge rectifier 24 V, 48 V, 60 V

Accessories	
Socket	S5-M, S5-P
Wall Mounting Adapter	S5-R (BAG 5 PCS)
Blanking Plug	SO-NP (BAG 10 PCS)

"..." List Coil Voltage to complete Product References



Connection diagram

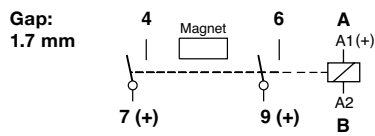


fig. 1 AC voltage endurance

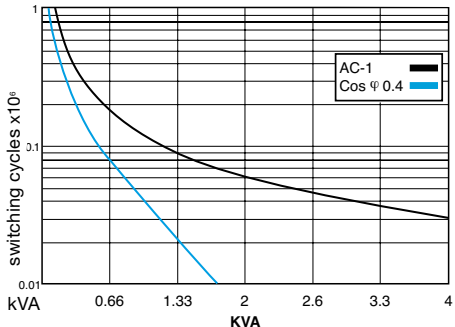
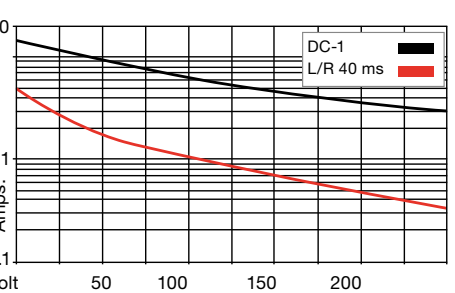
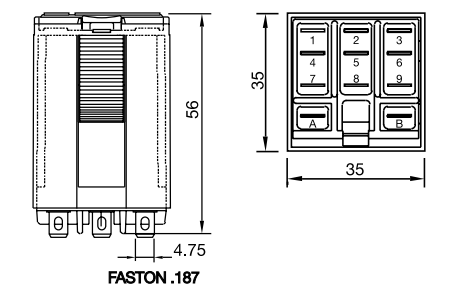


fig. 2 DC load limit curve



Dimensions (mm)



Technical approvals, conformities



C5-R2x

2 pole | changeover contact | remanance

Maximum contact load	10 A/400 V AC-1	10 A/30 V DC-1
	0.2 A/250 V DC-1	0.5 A/110 V DC-1
Recommended minimum contact load	10mA/10V	

Contacts	
Material	Standard Code 0 AgNi
Rated Load	10 A
Max. inrush current (20 ms)	30 A
Switching voltage max.	400 V
AC load fig. 1	4 kVA
DC load	see fig. 2

Coil	
Coil resistance	see table; tolerance ± 10 %
ON pulse power	1.5 VA/W
OFF pulse power	0.5 VA/W 1 winding for AC, 2 winding for DC
Pull-in ON OFF	< 0.8 x U _N

Coil table					
V AC	mA ON	mA OFF	V DC	mA ON	mA OFF
24	75	12	12	125	41
48	38	6	24	63	21
115	16	2.5	48	31	10
230	8	1.3	110	14	4.5

Insulation	
Contact open	1000 V
Contact/contact	4 kV
Contact/coil	4 kV
Insulation resistance at 500 V	≥ 3 GΩ
Insulation, EN 60947/IEC 61810-1:	4 kV

Specifications	
Ambient temperature operation/storage	-40...60 °C / -40 ... 80 °C (no ice)
Minimum pulse ON OFF	50 ms
Mechanical life ops	AC: 10 Mill./DC: 20 Mill.
DC voltage endurance at rated load	≥ 100 000 switching cycles
Max. switching frequency at rated load	1200/h
Weight	95 g

Product References	
V AC 50 Hz/60 Hz: 24, 48, 115, 230	C5-R20/AC ... V
V DC 12, 24, 48, 110,	C5-R20/DC ... V

Other voltages on request

"..." List Coil Voltage to complete Product References

Accessories	
Socket	S5-M, S5-P
Wall Mounting Adapter	S5-R (BAG 5 PCS)
Blanking Plug	SO-NP (BAG 10 PCS)

"..." List Coil Voltage to complete Product References



Connection diagram

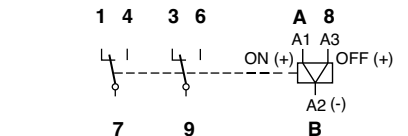


fig. 1 AC voltage endurance

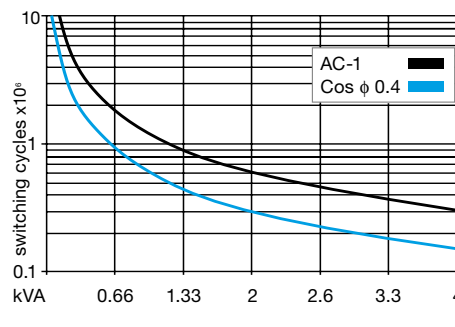
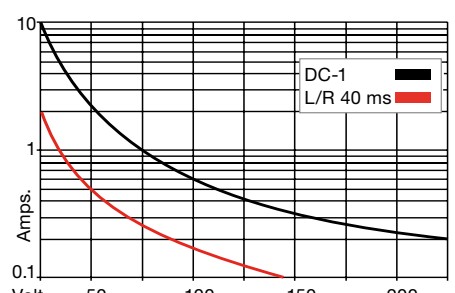
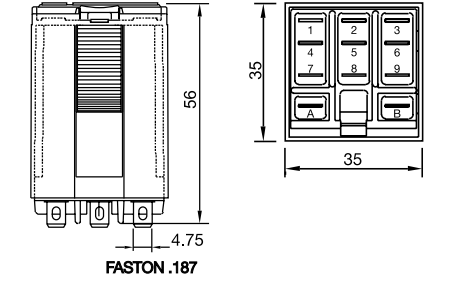


fig. 2 DC load limit curve



Dimensions (mm)



Technical approvals, conformities



C7-A1x

1 pole | changeover contact | Faston

Maximum contact load	16 A/250 V AC-1	0.5 A/110 V DC-1
	16 A/24 V DC-1	0.2 A/220 V DC-1
Recommended minimum contact load	10mA/10V	

Contacts

Material	Standard	Code 0	⚡ AgNi
Rated Load	16 A		
Max. inrush current (20 ms)	40 A (120 A for code 5)		
Switching voltage max.	250 V		
AC load fig. 1	4 kVA		
DC load	see fig. 2		

Coil

Coil resistance	see table; tolerance ± 10 %
Pick-up voltage	≤ 0.8 x U _n
Release voltage	≥ 0.1 x U _n
Nominal power	1.2 VA (AC)/1.3 W (DC)

Coil table

V AC	Ω	mA	V DC	Ω	mA
24	174	50	12	111	108
48	686	25	24	432	55
115	4K3	10.4	48	1K7	28
230	18K6	5.2	110	9K2	12

Insulation

Contact open	1000 V
Contact/coil	2.5 kV
Insulation resistance at 500 V	≥ 1 GΩ
Insulation, IEC 61810-1	2.5 kV

Specifications

Ambient temperature operation/storage	-40...60 °C / -40 ... 80 °C (no ice)
Pick-up time/bounce time	16 ms / ≤ 3 ms
Release time/bounce time	8 ms / ≤ 1 ms
Mechanical life ops	AC: 10 Mill./DC: 20 Mill.
AC/DC voltage endurance at rated load	≥ 100 000 switching cycles
Max. switching frequency at rated load	1200/h
Weight	43 g

Product References

V AC 50 Hz/60 Hz: 24, 48, 115 (120), 230 (240) LED

C7-A10X/AC ... V

V DC 12, 24, 48, 110

LED
Free wheeling diode (only 24 DC)
Polarity and free wheeling diode

C7-A10X/DC ... V
C7-A10DX/DC 24 V
C7-A10FX/DC ... V

Other voltages on request

"..." List Coil Voltage to complete Product References

Accessories

Socket	S7-C, S7-IO, S7-P
Push only	S9-OP (BAG 10 PCS)
Blanking Plug	S9-NP (BAG 10 PCS)



Connection diagram

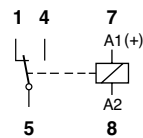


fig. 1 AC voltage endurance

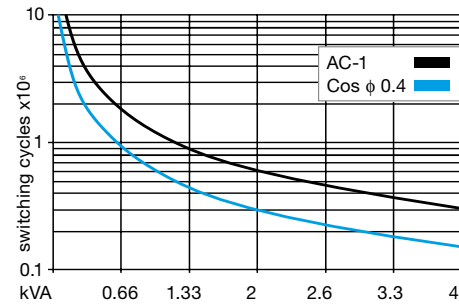
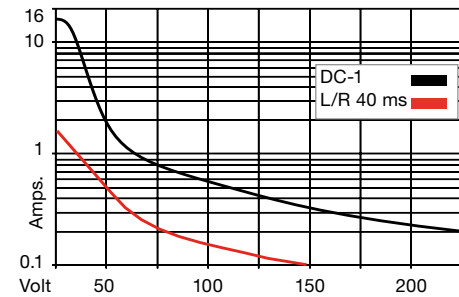
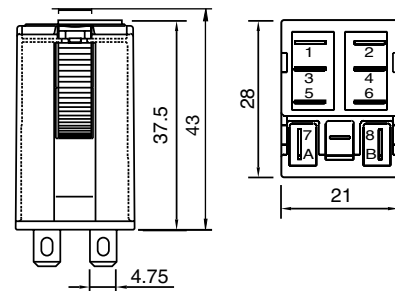


fig. 2 DC load limit curve



Dimensions (mm)



Technical approvals, conformities



C7-A2x

2 pole | changeover contact | Faston

Maximum contact load	10 A/250 V AC-1	0.5 A/110 V DC-1
	10 A/30 V DC-1	0.2 A/220 V DC-1
Recommended minimum contact load	10 mA/10 V Code 0	
	5 mA/5 V Code 8	

Contacts

Material	Standard	Code 0	⚡ AgNi
	Optional	Code 8	⚡ AgNi + 5 μ Au
Rated Load	10 A		
Max. inrush current (20 ms)	30 A		
Switching voltage max.	250 V		
AC load fig. 1	2.5 kVA		
DC load	see fig. 2		

Coil

Coil resistance	see table; tolerance ± 10 %
Pick-up voltage	≤ 0.8 x U _n
Release voltage	≥ 0.1 x U _n
Nominal power	1.2 VA (AC)/1 W (DC)

Coil table

V AC	Ω	mA	V DC	Ω	mA
24	174	50	12	148	85
48	686	25	24	594	43
115	4K3	10.4	48	2K3	21
230	18K6	5.2	110	11K4	10

Insulation

Contact open	1000 V
Contact/contact	2.5 kV
Contact/coil	2.5 kV
Insulation resistance at 500 V	≥ 1 GΩ
Insulation, IEC 61810-1	2.5 kV

Specifications

Ambient temperature operation/storage	-40...60 °C / -40 ... 80 °C (no ice)
Pick-up time/bounce time	16 ms / ≤ 3 ms
Release time/bounce time	8 ms / ≤ 1 ms
Mechanical life ops	AC: 10 Mill./DC: 20 Mill.
DC voltage endurance at rated load	≥ 100 000 switching cycles
Max. switching frequency at rated load	1200/h
Weight	43 g

Product References

V AC 50 Hz/60 Hz: 24, 48, 115 (120), 230 (240) LED

C7-A20X/AC ... V

C7-A28X/AC ... V

V DC 12, 24, 48, 110

LED
Free wheeling diode (only 24 DC)
Polarity and free wheeling diode

C7-A20X/DC ... V

C7-A28X/DC ... V

C7-A20DX/DC 24 V

C7-A28DX/DC 24 V

C7-A20FX/DC ... V

C7-A28FX/DC ... V

AC/DC bridge rectifier 24 V, 48 V, 60 V

C7-A20BX/UC ... V

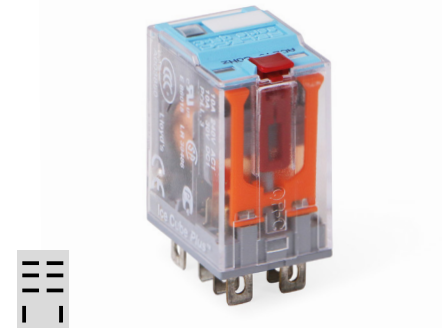
C7-A28BX/UC ... V

Other voltages on request

"..." List Coil Voltage to complete Product References

Accessories

Socket	S7-C, S7-IO, S7-P,
Push only	S9-OP (BAG 10 PCS)
Blanking Plug	S9-NP (BAG 10 PCS)



Connection diagram

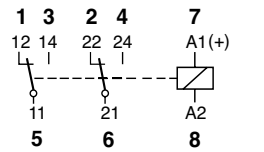


fig. 1 AC voltage endurance

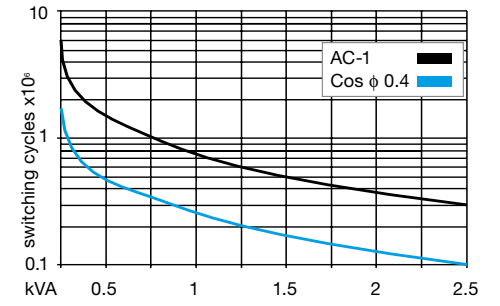
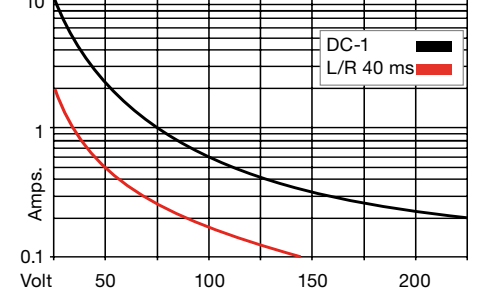
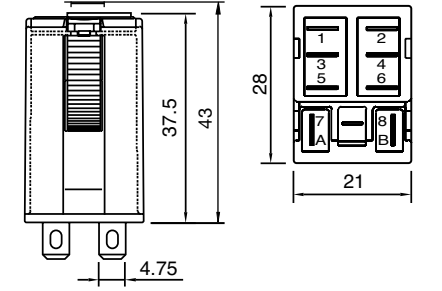


fig. 2 DC load limit curve



Dimensions (mm)



Technical approvals, conformities



C7-T2x

2 pole | changeover twin contact

Maximum contact load	6 A/250 V AC-1	6 A/30 V DC-1
Recommended minimum contact load	5 mA/5 V Code 1	1 mA/5 V Code 2

Contacts

Material	Standard	Code 1	AgNi + 0.2 μ Au
	Optional	Code 2	AgNi + 5 μ Au
Rated Load	6 A		
Max. inrush current (20 ms)	15 A		
Switching voltage max.	250 V		
AC load fig. 1	1.2 kVA		
DC load	see fig. 2		

Coil

Coil resistance	see table; tolerance ± 10 %
Pick-up voltage	≤ 0.8 x U _N
Release voltage	≥ 0.1 x U _N
Nominal power	1.2 VA (AC)/1 W (DC)

Coil table

V AC	Ω	mA	V DC	Ω	mA
24	174	50	12	148	85
48	686	25	24	594	43
115	4K3	10.4	48	2K3	21
230	18K6	5.2	110	11K4	10

Insulation

Contact open	1000 V
Contact/contact	2.5 kV
Contact/coil	2.5 kV
Insulation resistance at 500 V	≥ 1 GΩ
Insulation, IEC 61810-1	2.5 kV

Specifications

Ambient temperature operation/storage	-40...60 °C / -40 ... 80 °C (no ice)
Pick-up time/bounce time	16 ms / ≤ 3 ms
Release time/bounce time	8 ms / ≤ 1 ms
Mechanical life ops	AC: 10 Mill./DC: 20 Mill.
DC voltage endurance at rated load	≥ 100 000 switching cycles
Max. switching frequency at rated load	1200/h
Weight	43 g

Product References

V AC 50 Hz/60 Hz: 230 (240)

LED

C7-T21X/AC ... V

C7-T22X/AC230V

V DC 12, 24, 48, 110

LED

C7-T21X/DC ... V

C7-T21DX/DC24V

C7-T21FX/DC ... V

C7-T21BX/UC ... V

C7-T22FX/DC110V

C7-T22BX/UC24V

C7-T22BX/UC48V

Other voltages on request

"..." List Coil Voltage to complete Product References

Accessories

Socket	S7-C, S7-IO, S7-P,
Push only	S9-OP (BAG 10 PCS)
Blanking Plug	S9-NP (BAG 10 PCS)



Connection diagram

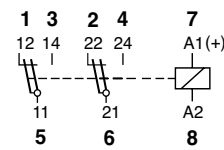


fig. 1 AC voltage endurance

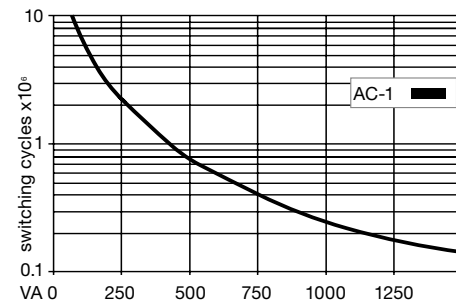
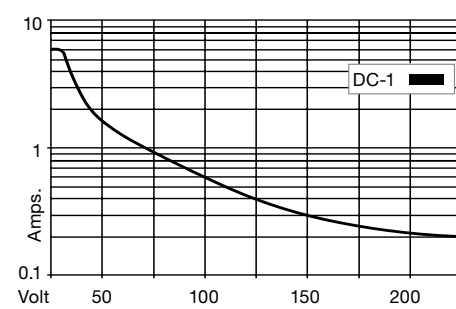
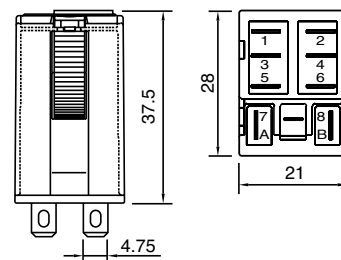


fig. 2 DC load limit curve



Dimensions (mm)



Technical approvals, conformities



C7-G2x

2 pole | normally open contact | Faston

Maximum contact load	10 A/250 V AC-1	0.8 A/110 V DC-1
Recommended minimum contact load	10 mA/30 V DC-1	0.4 A/220 V DC-1
	10mA/10V	

Contacts

Material	Standard	Code 0	AgNi
Rated Load	10 A		
Max. inrush current (20 ms)	30 A		
Switching voltage max.	250 V		
AC load fig. 1	2.5 kVA		
DC load	see fig. 2		

Coil

Coil resistance	see table; tolerance ± 10 %
Pick-up voltage	≤ 0.8 x U _N
Release voltage	≥ 0.1 x U _N
Nominal power	1.5 VA (AC)/1.5 W (DC)

Coil table

V AC	Ω	mA	V DC	Ω	mA
24	153	62	12	99	121
48	611	31	24	388	61
115	3K6	13	48	1K5	32
230	14K6	6.5	110	8K	14

Insulation

Contact open	2000 V
Contact/contact	2.5 kV
Contact/coil	2.5 kV
Insulation resistance at 500 V	≥ 1 GΩ
Insulation, IEC 61810-1	2.5 kV

Specifications

Ambient temperature operation/storage	-40...60 °C / -40 ... 80 °C (no ice)
Pick-up time/bounce time	20 ms / ≤ 3 ms
Release time/bounce time	10 ms / ≤ 1 ms
Mechanical life ops	AC: 10 Mill./DC: 20 Mill.
DC voltage endurance at rated load	≥ 100 000 switching cycles
Max. switching frequency at rated load	1200/h
Weight	43 g

Product References

V AC 50 Hz/60 Hz: 24, 48, 115 (120), 230 (240)

LED

C7-G20X/AC ... V

V DC 12, 24, 48, 110

LED

C7-G20FX/DC ... V

Polarity and free wheeling diode

C7-G20BX/UC ... V

AC/DC bridge rectifier 24 V, 48 V, 60 V

Other voltages on request

"..." List Coil Voltage to complete Product References

Accessories

Socket	S7-C, S7-IO, S7-P,
Push only	S9-OP (BAG 10 PCS)
Blanking Plug	S9-NP (BAG 10 PCS)



Connection diagram

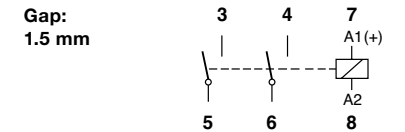


fig. 1 AC voltage endurance

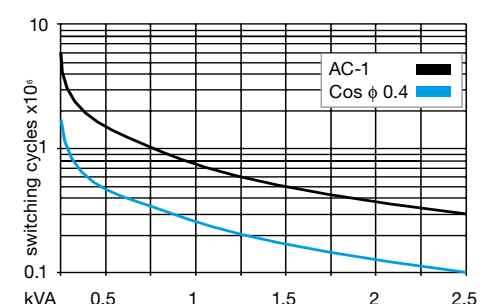
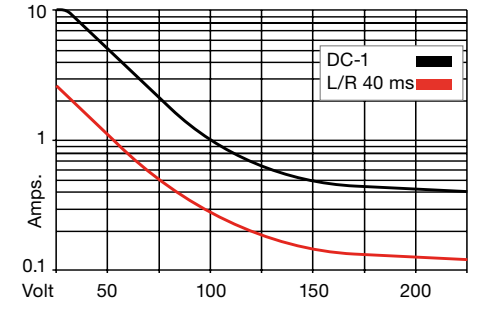
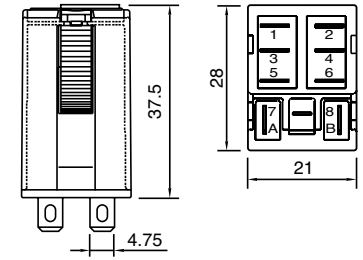


fig. 2 DC load limit curve



Dimensions (mm)



Technical approvals, conformities



C7-H2x

2 pole | changeover contact | Faston

Maximum contact load	10 A / 250 V AC-1	6 A / 250 V AC-1
	10 A / 30 V DC-1	6 A / 30 V DC-1
Recommended minimum contact load	10 mA/10 V (Power contacts)	
	5 mA/5V (twin contacts)	

Contacts

Material	Standard	Code 3	⚡ ⚡ AgNi + 3 μ Au
Rated Load	10 A		
Max. inrush current (20 ms)	30 A		
Switching voltage max.	2,5 kV		
AC load fig. 1	2,5 VA		
DC load	see fig. 2		

Coil

Coil resistance	see table; tolerance ± 10 %
Pick-up voltage	≤ 0.8 x U _n
Release voltage	≥ 0.1 x U _n
Nominal power	1.2 VA (AC)/1 W (DC)

Coil table

V AC	Ω	mA	V DC	Ω	mA
230	18K6	5.2	24	594	43

Insulation

Contact open	1000 V
Contact/contact	2.5 kV
Contact/coil	2.5 kV
Insulation, IEC 61810-1	2.5 kV

Specifications

Ambient temperature operation/storage	-40...60 °C / -40 ... 80 °C (no ice)
Pick-up time/bounce time	16 ms / ≤ 3 ms
Release time/bounce time	8 ms / ≤ 1 ms
Mechanical life ops	AC: 10 Mill./DC: 20 Mill.
DC voltage endurance at rated load	≥100 000 switching cycles
Max. switching frequency at rated load	1200/h
Weight	43 g

Product References

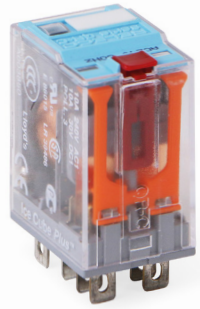
LED (only 230 V AC)	C7-H23X/AC 230 V
Free wheeling diode (only 24 DC)	C7-H23X/DC 24 V

Other voltages on request

"..." List Coil Voltage to complete Product References

Accessories

Socket	S7-C, S7-IO, S7-P,
Push only	S9-OP (BAG 10 PCS)
Blanking Plug	S9-NP (BAG 10 PCS)



Connection diagram

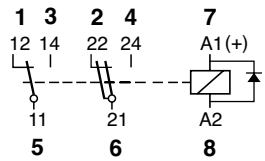


fig. 1 AC voltage endurance

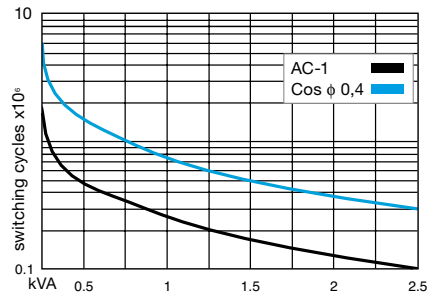
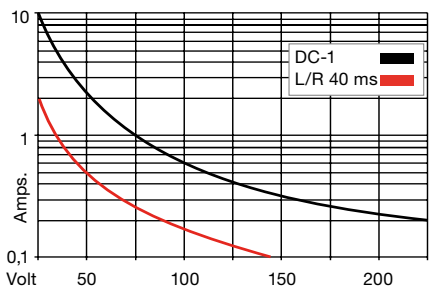
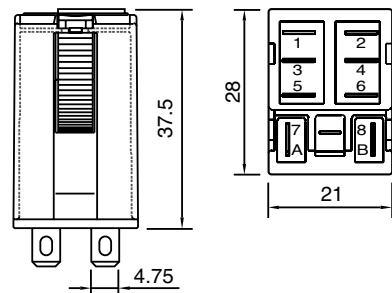


fig. 2 DC load limit curve



Dimensions (mm)



Technical approvals, conformities



IEC 61810; EN 60947

C7-X1x

1 pole | normally open serial contact | Faston

Maximum contact load	10 A/250 V AC-1	6 A/110 V DC-1
	10 A/30 V DC-1	1 A/220 V DC-1
Recommended minimum contact load	10mA/10V	

Contacts

Material	Standard	Code 0	⚡ AgNi
Rated Load	10 A		
Max. inrush current (20 ms)	30 A		
Switching voltage max.	250 V		
AC load	2.5 kVA		
DC load	see fig. 2		

Coil

Coil resistance	see table; tolerance ± 10 %
Pick-up voltage	≤ 0.8 x U _n
Release voltage	≥ 0.1 x U _n
Nominal power	1.5 VA (AC)/1.3 W (DC)

Coil table

V AC	Ω	mA	V DC	Ω	mA
24	153	62	12	111	108
48	611	31	24	432	55
115	3K6	13	48	1K7	27
230	14K6	6.5	110	9K2	12

Insulation

Contact open	2.5 kV
Contact/coil	2.5 kV
Insulation resistance at 500 V	≥1 GΩ
Insulation, IEC 61810-1	2.5 kV

Specifications

Ambient temperature operation/storage	-40...60 °C / -40 ... 80 °C (no ice)
Pick-up time/bounce time	20 ms / ≤ 3 ms
Release time/bounce time	10 ms / ≤ 1 ms
Mechanical life ops	AC: 10 Mill./DC: 20 Mill.
DC voltage endurance at rated load	≥100 000 switching cycles
Max. switching frequency at rated load	1200/h
Weight	43 g

Product References

V AC 50 Hz/60 Hz: 24, 48, 115 (120), 230 (240) LED	C7-X10X/AC ... V
V DC 12, 24, 48, 110 LED	C7-X10X/DC ... V
Free wheeling diode (only 24 DC)	C7-X10DX/DC 24 V
Polarity and free wheeling diode	C7-X10FX/DC ... V
AC/DC bridge rectifier 24 V, 48 V, 60 V	C7-X10BX/UC ... V

Other voltages on request

"..." List Coil Voltage to complete Product References

Accessories

Socket	S7-C, S7-IO, S7-P,
Push only	S9-OP (BAG 10 PCS)
Blanking Plug	S9-NP (BAG 10 PCS)



Connection diagram

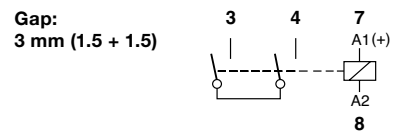


fig. 1 AC voltage endurance

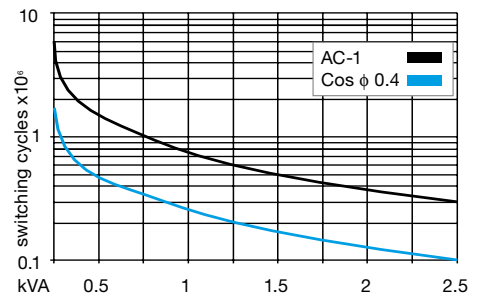
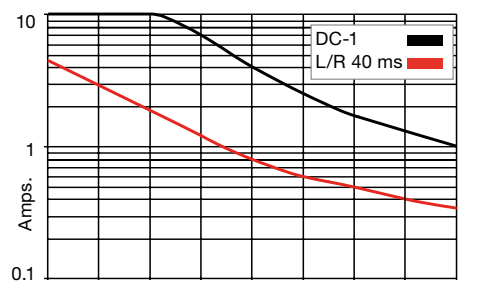
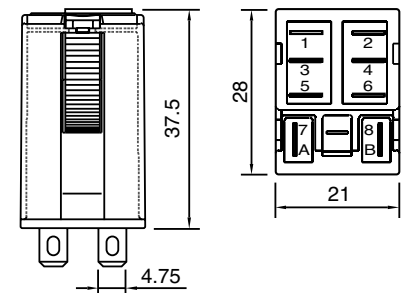


fig. 2 DC load limit curve



Dimensions (mm)



Technical approvals, conformities



IEC/EN 61810; IEC/EN 60947

C7-W1x

1 pole | normally open tungsten pre-contact | Faston

Maximum contact load:	10 A/250 V AC-1	6 A / 250 V AC-5a/b
Recommended minimum contact load:	10 mA/10 V	

Contacts

Material	Standard	Code 0	⚡ AgNi/W
Rated Load			10 A
Max. inrush current (2.5 ms)			500 A
Switching voltage max.			250 V
AC load fig. 1			2.5 kVA
DC load			see fig. 2

Coil

Coil resistance	see table; tolerance ± 10 %
Pick-up voltage	≤ 0.8 x U _N
Release voltage	≥ 0.1 x U _N
Nominal power	1.5 VA (AC)/1.5 W (DC)

Coil table

V AC	Ω	mA	V DC	Ω	mA
24	153	62	12	99	121
48	611	31	24	388	61
115	3K6	13	48	1K5	32
230	14K5	6.5	110	8K	14

Insulation

Contact open	1000 V
Contact/coil	2.5 kV
Insulation resistance at 500 V	≥ 1 GΩ
Insulation, IEC 61810-1	2.5 kV

Specifications

Ambient temperature operation/storage	-40...60 °C / -40 ... 80 °C (no ice)
Pick-up time/bounce time	20 ms / ≤ 3 ms
Release time/bounce time	10 ms / ≤ 1 ms
Mechanical life ops	AC: 10 Mill./DC: 20 Mill.
DC voltage endurance at rated load	≥ 100 000 switching cycles
Max. switching frequency at rated load	1200/h
Weight	43 g

Product References

V AC 50 Hz/60 Hz: 24, 48, 115 (120), 230 (240) LED

C7-W10X/AC ... V

V DC 12, 24, 48, 110

LED

Polarity and free wheeling diode

C7-W10FX/DC ... V

AC/DC bridge rectifier 24 V, 48 V, 60 V

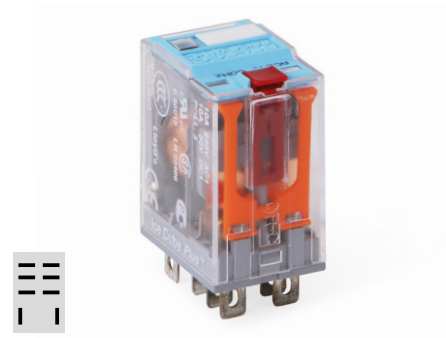
C7-W10BX/UC ... V

Other voltages on request

"..." List Coil Voltage to complete Product References

Accessories

Socket	S7-C, S7-IO, S7-P,
Push only	S9-OP (BAG 10 PCS)
Blanking Plug	S9-NP (BAG 10 PCS)



Connection diagram

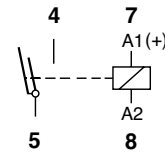


fig. 1 AC voltage endurance

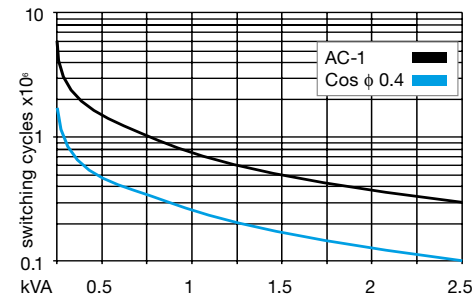
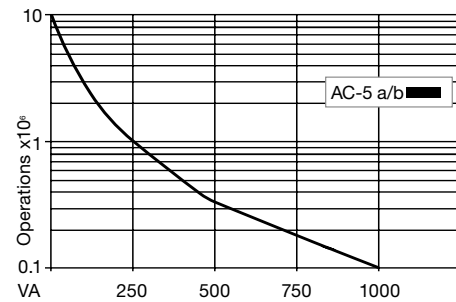
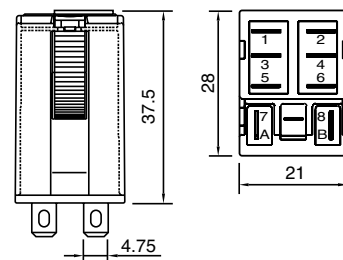


fig. 2 DC load limit curve



Dimensions (mm)



Technical approvals, conformities



IEC/EN 61810; IEC/EN 60947

R7-A2x

2 pole | changeover contact | Faston

Maximum contact load:	10 A/250 V AC-1	10A/30V DC-1
Recommended minimum contact load:	10 mA/10 V Code 0	5 mA/5 V Code 8

Contacts

Material	Standard	Code 0	⚡ AgNi
	Optional	Code 8	⚡ AgNi + 5 μ Au
Rated Load			10 A
Max. inrush current (20 ms)			30 A
Switching voltage max.			250 V
AC load			see fig. 1
DC load			see fig. 2

Coil

Coil resistance	see table; tolerance ± 10 %
Operating range	0,7 U _N ... 1,25 U _N
Pick-up voltage	≥ 0,1 x U _N
Nominal power	1,07 W

Coil table

Voltage	Ω ± 10%	mA
24	535	45
48	2004	24
72	4750	15
110	11337	10

Insulation

Contact open	1000V
Contact/Contact	4kV / 2200V
Contact/coil	4kV / 2200V
Insulation resistance at 500 V	≥ 1 GΩ
Insulation, IEC 61810-1	2,5 kV

Specifications

Ambient temperature operation/storage	-25...70 °C / -40 ... 80 °C (no ice)
Pick-up time/bounce time	16 ms / ≤ 3 ms
Release time/bounce time	8 ms / ≤ 1 ms
Mechanical life ops	AC: 10 Mill./DC: 20 Mill.
DC voltage endurance at rated load	≥ 100 000 switching cycles
Max. switching frequency at rated load	1200/h
Weight	35 g

Product References

V DC 12, 24, 48, 72, 110 LED + free wheeling diode

R7-A20DX/DC... V

R7-A28DX/DC... V

Other voltages on request

"..." List Coil Voltage to complete Product References

Accessories

Socket	S7-C, S7-I/O, S7-P
--------	---------------------------



Connection diagram

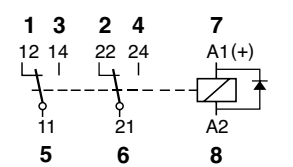


fig. 1 AC voltage endurance

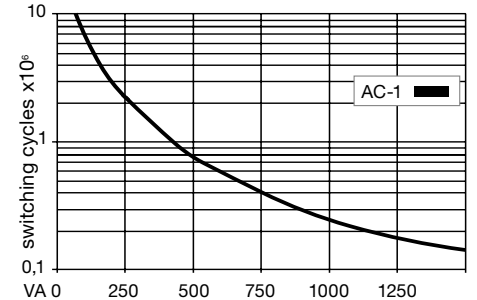
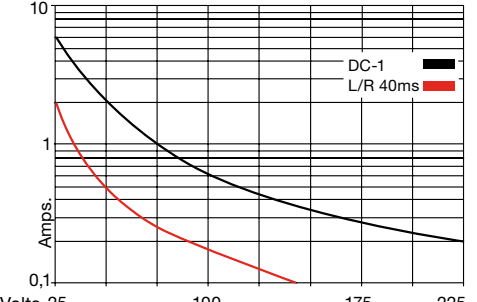
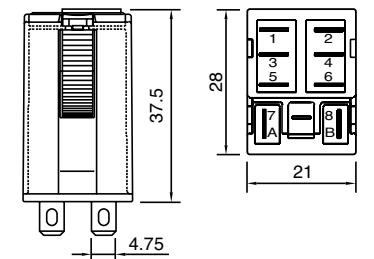


fig. 2 DC load limit curve



Dimensions (mm)



Technical approvals, conformities



IEC 60077; EN 60077-1-2/99; EN 61373/99

R7-T2x

2 pole | changeover twin contact

Maximum contact load:	10 A/250 V AC-1 10A/30V DC-1
Recommended minimum contact load	10 mA/10 V Code 2

Contacts

Material	Standard	Code 2	AgNi + 5 µ Au
----------	----------	--------	---------------

Rated Load	6 A
Max. inrush current (20 ms)	30 A
Switching voltage max.	250 V
AC load	see fig. 1
DC load	see fig. 2

Coil

Coil resistance	see table; tolerance ± 10 %
Pick-up voltage	0,7 U _N ... 1,25 U _N
Release voltage	≥ 0,1 x U _N
Nominal power	1,07 W

Coil table

Voltage	Ω ± 10%	mA
24	535	45
48	2004	24
72	4750	15
110	11337	10

Insulation

Contact open	1000V
Contact/contact	4kV / 2200V
Contact/coil	4kV / 2200V
Insulation resistance at 500 V	≥1 GΩ
Insulation, IEC 61810-1	2,5 kV

Specifications

Ambient temperature operation/storage	-25...70 °C /-40 ... 80 °C (no ice)
Pick-up time/bounce time	16 ms /≤ 3 ms
Release time/bounce time	8 ms /≤ 1 ms
Mechanical life ops	AC: 10 Mill./DC: 20 Mill.
DC voltage endurance at rated load	≥100 000 switching cycles
Max. switching frequency at rated load	1200/h
Weight	35 g

Product References

V DC 12, 24, 72, 110
LED + free wheeling diode

R7-T22DX/DC...V

Other voltages on request

"..." List Coil Voltage to complete Product References

Accessories

Socket **S7-C, S7-I/O, S7-P**



Connection diagram

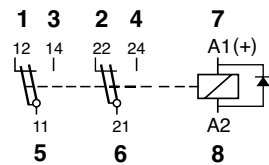


fig. 1 AC voltage endurance

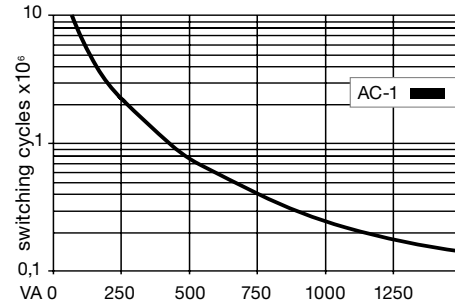
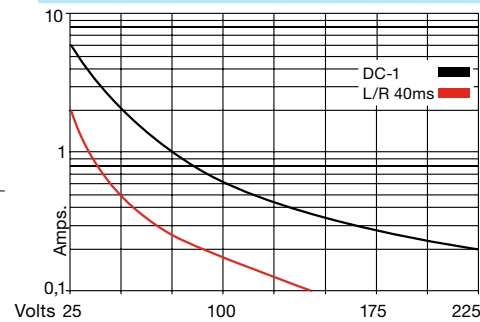
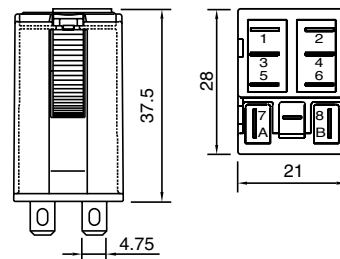


fig. 2 DC load limit curve



Dimensions (mm)



Technical approvals, conformities



IEC 60077; EN 60077-1-2/99; EN 61373/99

C9-A4x

4 pole | changeover contact | Faston

Maximum contact load	5 A/250 V AC-1 5 A/30 V DC-1
Recommended minimum contact load	10 mA/10 V Code 1 1 mA/5 V Code 2

Contacts

Material	Standard	Code 1	AgNi + 0.2 µ Au
	Optional	Code 2	AgNi + 5 µ Au

Rated Load	5 A
Max. inrush current (20 ms)	15 A
Switching voltage max (same polarity)	250 V
AC load fig. 1	1250 VA
DC load	see fig. 2

Coil

Coil resistance	see table; tolerance ± 10 %
Pick-up voltage	≤ 0.8 x U _N
Release voltage	≥ 0.1 x U _N
Nominal power	1.2 VA (AC)/1 W (DC)

Coil table

V AC	Ω	mA	V DC	Ω	mA
24	174	50	12	148	81
48	686	25	24	594	40
115	4K3	10.4	48	2K3	21
230	18K6	5.2	110	11K4	11

Insulation

Contact open	1000 V
Contact/contact	2 kV
Contact/coil	2.5 kV
Insulation resistance at 500 V	≥1 GΩ
Insulation, IEC 61810-1	2.5 kV

Specifications

Ambient temperature operation/storage	-40...60 °C /-40 ... 80 °C (no ice)
Pick-up time/bounce time	10 ms /≤ 3 ms
Release time/bounce time	6 ms /≤ 1 ms
Mechanical life ops	AC: 10 Mill./DC: 20 Mill.
DC voltage endurance at rated load	≥100 000 switching cycles
Max. switching frequency at rated load	1200/h
Weight	43 g

Product References

V AC 50 Hz/60 Hz: 24, 48, 115, 230 (240)

LED

V DC 12, 24, 48, 110

LED

Free wheeling diode (only 24 DC)

Polarity and free wheeling diode

AC/DC bridge rectifier 24 V, 48 V, 60 V

Other voltages on request

"..." List Coil Voltage to complete Product References

Accessories

Socket **S9-M, S9-P**
Push only **S9-OP (BAG 10 PCS)**
Blanking Plug **S9-NP (BAG 10 PCS)**



Maximum voltage between two separate circuits on neighbouring contacts: 150 V
Not permitted: 24 V DC next to 230 V AC, 230 V AC next to neutral, 230 V AC next to 230 V AC of different phases
Permitted: 230 V AC next to 230 V AC same phase



Connection diagram

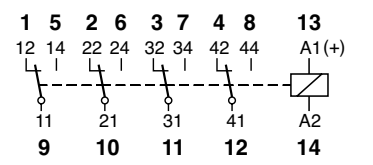


fig. 1 AC voltage endurance

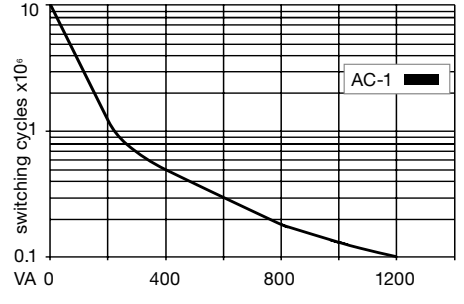
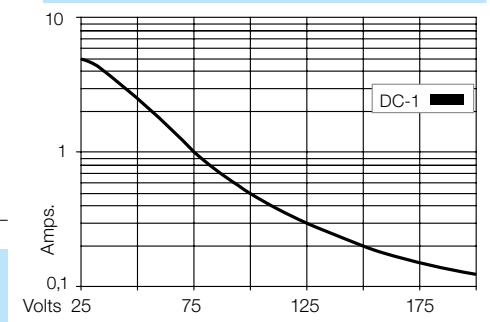
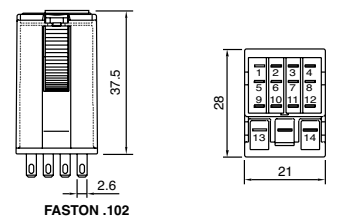


fig. 2 DC load limit curve



Dimensions (mm)



Technical approvals, conformities



IEC/EN 61810; IEC/EN 60947

C9-E2x

2 pole | changeover contact | sensitive coil | Faston

Maximum contact load	5 A/250 V AC-1	5 A/30 V DC-1
Recommended minimum contact load	10 mA/10 V Code 1	

Contacts			
Material	Standard	Code 1	AgNi + 0.2 μ Au
Rated Load			5 A
Max. inrush current (20 ms)			15 A
Switching voltage max.			250 V
AC load fig. 1			1200 VA
DC load			see fig. 2

Coil	
Coil resistance	see table; tolerance ± 10 %
Pick-up voltage	≤ 0.8 x U _n
Release voltage	≥ 0.1 x U _n
Nominal power	0.8 VA (AC)/0.5 W (DC)

Coil table	V AC	Ω	mA	V DC	Ω	mA
	24	238	33	12	288	42
	48	1K	17	24	1K1	21
	115	5K9	7	48	4K6	10
	230	23K9	3.5	110	24K2	4.5

Insulation	
Contact open	1000 V
Contact/contact	2.5 kV
Contact/coil	2.5 kV
Insulation resistance at 500 V	≥ 1 GΩ
Insulation, IEC 61810-1	2.5 kV

Specifications	
Ambient temperature operation/storage	-40...60 °C / -40 ... 80 °C (no ice)
Pick-up time/bounce time	10 ms / ≤ 3 ms
Release time/bounce time	6 ms / ≤ 1 ms
Mechanical life	AC: 10 Mill./DC: 20 Mill.
DC voltage endurance at rated load	≥ 100 000 switching cycles
Max. switching frequency at rated load	1200/h
Weight	40 g

Product References
V AC 50 Hz/60 Hz: 24, 48, 115, 230 (240) LED

C9-E21X/AC ... V

V DC 12, 24, 48, 110, 220 LED
Free wheeling diode (only 24 DC)
Polarity and free wheeling diode

C9-E21X/DC ... V
C9-E21DX/DC 24 V
C9-E21FX/DC ... V

AC/DC bridge rectifier 24 V, 48 V, 60 V
 Other voltages on request

C9-E21BX/UC ... V

"..." List Coil Voltage to complete Product References

Accessories	
Socket	S9-M, S9-P
Push only	S9-OP (BAG 10 PCS)
Blanking Plug	S9-NP (BAG 10 PCS)



Connection diagram

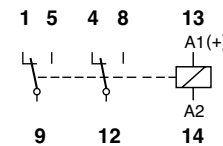


fig. 1 AC voltage endurance

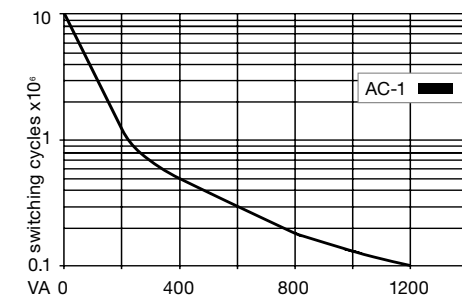
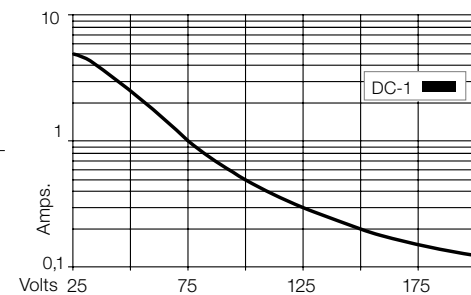
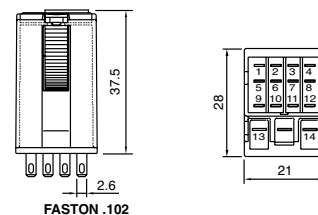


fig. 2 DC load limit curve



Dimensions (mm)



Technical approvals, conformities



C9-R2x

2 pole | changeover contact | remanance | Faston

Maximum contact load	5 A/120V AC-1	5 A/30 V DC-1
Recommended minimum contact load	10 mA/10 V	

Contacts			
Material	Standard	Code 1	AgNi + 0.2 μ Au
Rated Load			5 A
Max. inrush current (20 ms)			15 A
Switching voltage max.			120V
AC load			600 VA
DC load			see fig. 2

Coil	
Coil resistance	see table; tolerance ± 10 %
ON pulse power	1.2 VA/W
OFF pulse power	0.3 VA/W
1 winding for AC, 2 winding for DC	

Internal Diagram:	Coil table					
	V AC mA ON	mA OFF	V DC mA ON	mA OFF		
	24	50	8	12	100	25
	48	25	4	24	50	12
	115	10	2	48	25	6
	230	5	1	60	20	5

Insulation	
Contact open	1000 V
Contact/contact	2 kV
Contact/coil	2 kV
Insulation resistance at 500 V	≥ 1 GΩ
Insulation, IEC 61810-1	2.5 kV

Specifications	
Ambient temperature operation/storage	-40...60 °C / -40 ... 80 °C (no ice)
Minimum pulse ON OFF	50 ms
Mechanical life	AC: 10 Mill./DC: 20 Mill.
DC voltage endurance at rated load	≥ 100 000 switching cycles
Max. switching frequency at rated load	1200/h
Weight	43 g

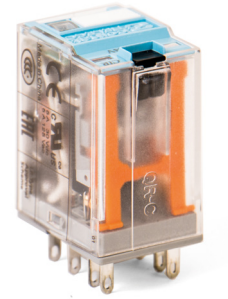
Product References
AC 50 Hz/60 Hz: 24, 48, 115, 230
DC 12, 24, 48, 60
 Other voltages on request

C9-R21N/AC ... V

C9-R21N/DC ... V

"..." List Coil Voltage to complete Product References

Accessories	
Socket	S9-M, S9-P
Push only	S9-OP (BAG 10 PCS)
Blanking Plug	S9-NP (BAG 10 PCS)



Connection diagram

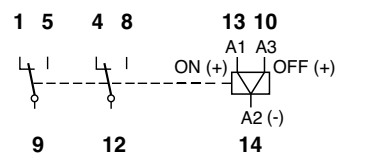


fig. 1 AC voltage endurance

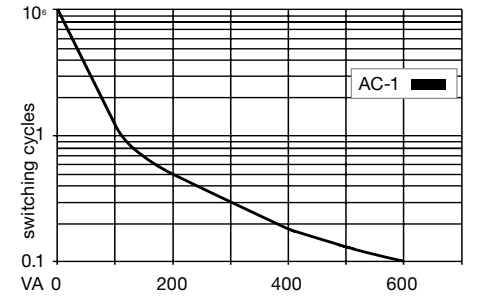
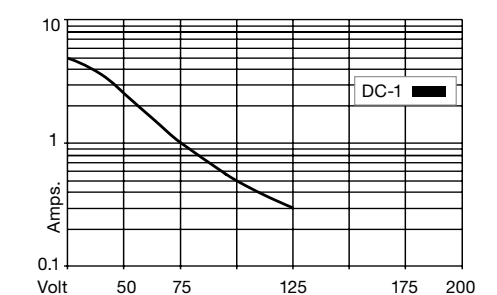
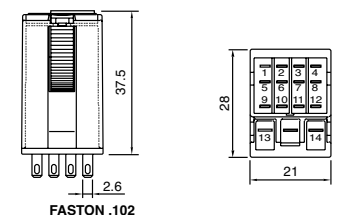


fig. 2 DC load limit curve



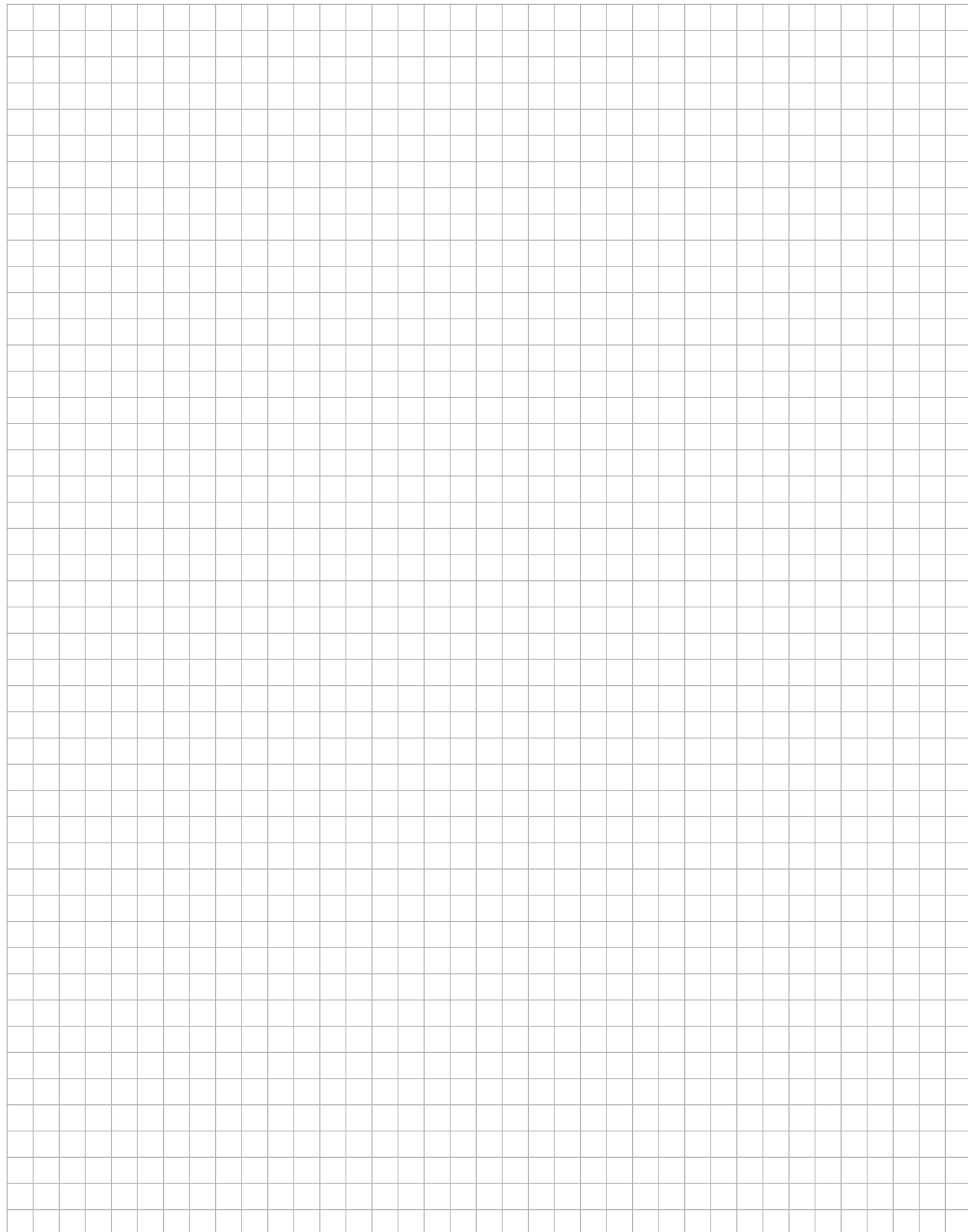
Dimensions (mm)







Technical approvals, conformities



Notes



1.4 Extended Lifetime Relays

Application	Type	Pin	Page
C2x Series			
Power relay	C21		68
Control relay	C22		69
C3x Series			
Power relay	C31		70
Control relay	C32		71

C21

Power relay

Maximum contact load	10 A / 250 V AC-1, 10 A / 30 V DC-1
Recommended minimum contact load	50 mA / 10 V

Contacts

Material	AgCuNi
Rated operational current	10 A
Max. inrush current (20 ms)	40 A
Rated switching voltage AC-1	250 V
Max. AC load	2500 VA AC-1
Max. DC load 30 V / 230 V DC-1 fig. 2	300 W / 90 W

Coil

Pick-up voltage	$\leq 0.8 \times U_N$
Release voltage AC / DC	$> 0.15 \times U_N / > 0.05 \times U_N$
Nominal power AC / DC	2.5 VA / 1.2 W

Coil Table

V_N AC	Ω	mA	V_N DC	Ω	mA
24	52	104	12	115	104
48	240	55	24	480	50
115	1350	23	48	1850	26
230	5600	11.5	110	9000	12
			220	29000	7.6

Types with LED indicator take additional 5 ... 10 mA @ < 80 V

Insulation

Contact Open	1.5 kV rms / 1 min
Contact Contact	1.5 kV rms / 1 min
Contact Coil	2 kV rms / 1 min

Specifications

Ambient temperature operation, storage	-40 ... 70 °C (no ice)
Pickup time AC / DC	3 ... 10 ms / ≤ 12 ms
Release time AC / DC	2 ... 15 ms / ≤ 3.5 ms
Bounce time NO contact AC / DC	3 ... 6 ms / approx. 3.5 ms
Mechanical life	$\geq 100\ 000\ 000$ operations
Max. switching frequency at rated load	360/h
Weight	80 g

Product References

AC 50 Hz / 60 Hz: 24, 48, 115, 230

LED

DC: 12, 24, 48, 110, 220

LED + Free wheeling diode

C21L/AC...V

C21DL/DC...V

"..." List Coil Voltage to complete Product References

Accessories

Socket **S2-B, S2-PO**



Connection diagram

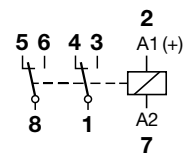


fig. 1 AC voltage endurance

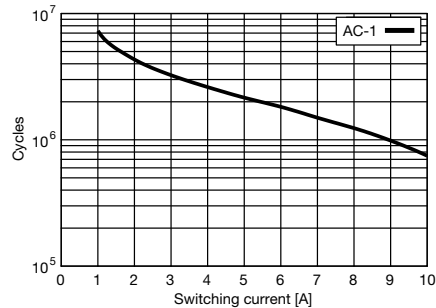
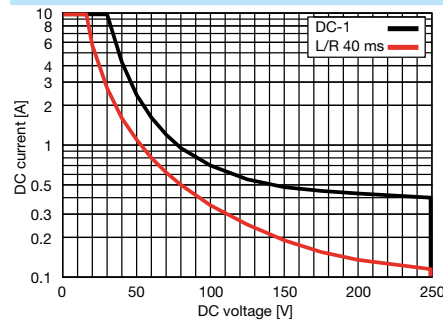
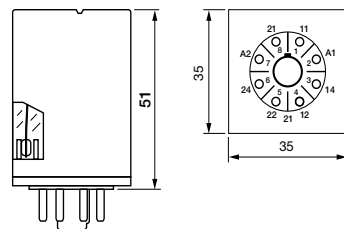


fig. 2 DC load limit curve



Dimensions (mm)



Technical approvals, conformities



C22

Control relay

Maximum contact load	6 A / 250 V AC-1, 6 A / 30 V DC-1
Recommended minimum contact load	10 mA / 5 V

Contacts

Material	AgCuNi
Rated operational current	6 A
Max. inrush current (20 ms)	15 A
Rated switching voltage AC-1	250 V
Max. AC load	1500 VA AC-1
Max. DC load 30V / 230V DC-1 fig. 2	200 W / 90 W

Coil

Pick-up voltage	$\leq 0.8 \times U_N$
Release voltage AC / DC	$> 0.15 \times U_N / > 0.05 \times U_N$
Nominal power AC / DC	2.5 VA / 1.2 W

Coil Table

V_N AC	Ω	mA	V_N DC	Ω	mA
24	52	104	12	115	104
48	240	55	24	480	50
115	1350	23	48	1850	26
230	5600	11.5	110	9000	12
			220	29000	7.6

Types with LED indicator take additional 5 ... 10 mA @ < 80 V

Insulation

Contact Open	1.5 kV rms / 1 min
Contact Contact	1.5 kV rms / 1 min
Contact Coil	2 kV rms / 1 min

Specifications

Ambient temperature operation, storage	-40 ... 70 °C (no ice)
Pickup time AC / DC	3 ... 10 ms / ≤ 12 ms
Release time AC / DC	2 ... 15 ms / ≤ 3.5 ms
Bounce time NO contact AC / DC	3 ... 6 ms / approx. 3.5 ms
Mechanical life	$\geq 100\ 000\ 000$ operations
Max. switching frequency at rated load	360/h
Weight	80 g

Product References

AC 50 Hz / 60 Hz: 24, 48, 115, 230

LED

DC: 12, 24, 48, 110, 220

LED + Free wheeling diode

C22L/AC...V

C22DL/DC...V

"..." List Coil Voltage to complete Product References

Accessories

Socket **S2-B, S2-PO**



Connection diagram

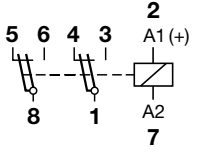


fig. 1 AC voltage endurance

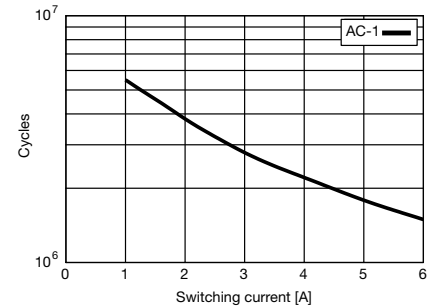
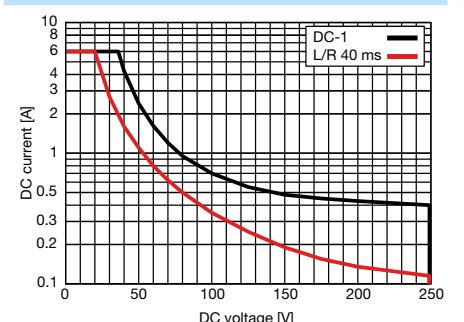
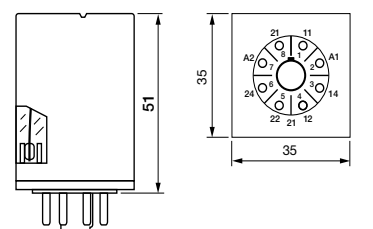


fig. 2 DC load limit curve



Dimensions (mm)



Technical approvals, conformities



C31

Power relay

Maximum contact load	10 A / 250 V AC-1 10 A / 30 V DC-1
Recommended minimum contact load	50 mA / 10 V

Contacts

Material	AgCuNi
Rated operational current	10 A
Max. inrush current (20 ms)	40 A
Rated switching voltage	250 V
Max. AC load	2500 VA AC-1
Max. DC load 30V / 230V DC-1 fig. 2	300W / 90 W

Coil

Pick-up voltage	$\leq 0.8 \times U_N$
Release voltage AC / DC	$> 0.15 \times U_N / > 0.05 \times U_N$
Nominal power AC / DC	2.5 VA / 1.2 W

Coil Table

V_N AC	Ω	mA	V_N DC	Ω	mA
24	52	104	12	115	104
48	240	55	24	480	50
115	1350	23	48	1850	26
230	5600	11.5	110	9000	12
			220	29000	7.6

Types with LED indicator take additional 5 ... 10 mA @ < 80 V

Insulation

Contact Open	1.5 kV rms / 1 min
Contact Contact	1.5 kV rms / 1 min
Contact Coil	2 kV rms / 1 min

Specifications

Ambient temperature operation, storage	-40 ... 70 °C (no ice)
Pickup time AC / DC	3 ... 10 ms / ≤ 12 ms
Release time AC / DC	2 ... 15 ms / ≤ 3.5 ms
Bounce time NO contact AC / DC	3 ... 6 ms / approx. 3.5 ms
Mechanical life	$\geq 100\ 000\ 000$ operations
Max. switching frequency at rated load	360/h
Weight	80 g

Product References

AC 50 Hz / 60 Hz: 24, 48, 115, 230 (240)

LED

DC: 12, 24, 48, 110, 220

LED + Free wheeling diode

Railway EN 50155

C31L/AC...V
C31/DC...V
C31DL/DC...V
C31D/R DC...V

"..." List Coil Voltage to complete Product References

Accessories

Socket **S3-B, S3-S, S3-PO, S3-M0, S3-M1**
Blanking Plug **SO-NP (BAG 10 PCS)**



Connection diagram

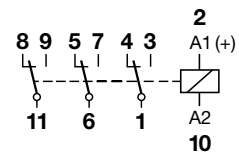


fig. 1 AC voltage endurance

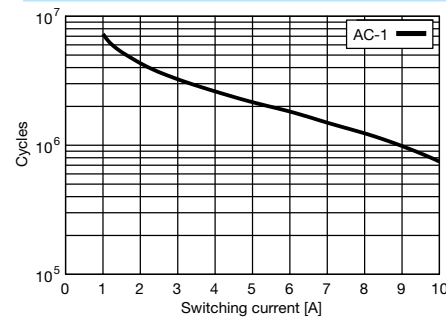
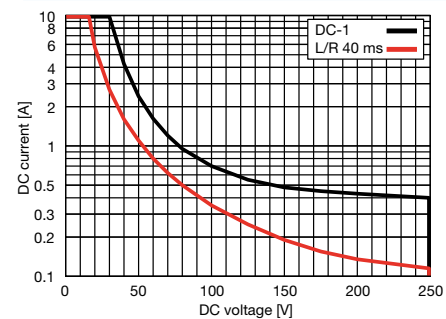
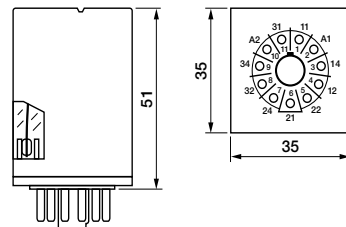


fig. 2 DC load limit curve



Dimensions (mm)



Technical approvals, conformities



IEC/EN 61810; IEC/EN 60947; IEC/EN 50155
IEC/EN 61373; IEC/EN 45545
NF F 16-101/102

C32

Control relay

Maximum contact load	6 A / 250 V AC-1 6 A / 30 V DC-1
Recommended minimum contact load	1 mA / 5 V

Contacts

Material	AgCuNi
Rated operational current	6 A
Max. inrush current (20 ms)	15 A
Rated switching voltage AC-1	250 V
Max. AC load	1500 VA AC-1
Max. DC load 30V / 230V DC-1 fig. 2	200 W / 90 W

Coil

Pick-up voltage	$\leq 0.8 \times U_N$
Release voltage AC / DC	$> 0.15 \times U_N / > 0.05 \times U_N$
Nominal power AC / DC	2.5 VA / 1.2 W

Coil Table

V_N AC	Ω	mA	V_N DC	Ω	mA
24	52	104	12	115	104
48	240	55	24	480	50
115	1350	23	48	1850	26
230	5600	11.5	110	9000	12
			220	29000	7.6

Types with LED indicator take additional 5 ... 10 mA @ < 80 V

Insulation

Contact Open	1.5 kV rms / 1 min
Contact Contact	1.5 kV rms / 1 min
Contact Coil	2 kV rms / 1 min

Specifications

Ambient temperature operation, storage	-40 ... 70 °C (no ice)
Pickup time AC / DC	3 ... 10 ms / ≤ 12 ms
Release time AC / DC	2 ... 15 ms / ≤ 3.5 ms
Bounce time NO contact AC / DC	3 ... 6 ms / approx. 3.5 ms
Mechanical life	$\geq 100\ 000\ 000$ operations
Max. switching frequency at rated load	360/h
Weight	80 g

Product References

AC 50 Hz / 60 Hz: 24, 48, 115, 230 (240)

LED

DC: 12, 24, 48, 110, 220

LED + Free wheeling diode

Railway EN 50155

C32L/AC...V
C32/DC...V
C32DL/DC...V
C32D/R DC...V

"..." List Coil Voltage to complete Product References

Accessories

Socket **S3-B, S3-S, S3-PO, S3-M0, S3-M1**
Blanking Plug **SO-NP (BAG 10 PCS)**



Connection diagram

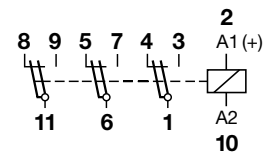


fig. 1 AC voltage endurance

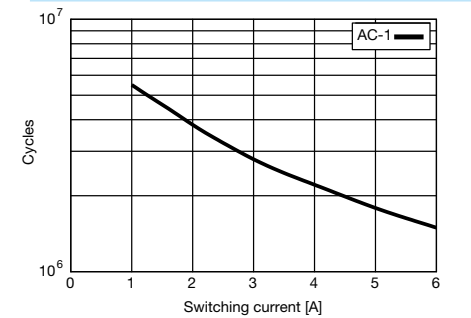
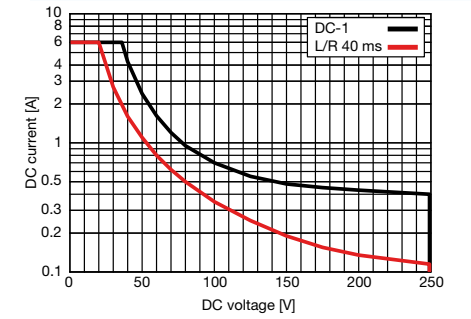
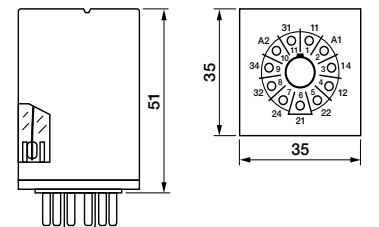


fig. 2 DC load limit curve



Dimensions (mm)



Technical approvals, conformities



IEC/EN 61810; IEC/EN 60947; IEC/EN 50155
IEC/EN 61373; IEC/EN 45545
NF F 16-101/102

CSS-I

1 pole | normally open solid state AC | Faston

Output	1 NO
Operating range	3 A, 24 ... 250 V AC, 50/60 Hz
Minimum contact load	35 mA

Contact

Type	1 NO (Solid state AC)
Material	Triac
Rated Load	3 A AC

Control circuit

Input voltage range	5 ... 48 V DC
Input current	10 mA

Output circuit

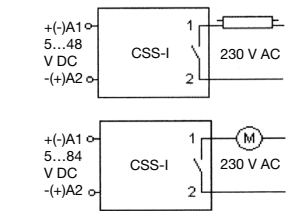
Max. output current	3 A
Min. output current	35 mA
Output voltage range	24...250 V AC
Inrush current	150 A/10 ms
Residual current	1 mA
I ^t value	210 A ² s

Specifications

Ambient temperature operation/storage	-40 ... 70 °C / -40 ... 85 °C (no ice)
Pick-up time	0.06 ms
Release time	0.06 ms
Weight	28 g

Applications

It is specially suitable to switch inductive loads up to 3A/250 V AC. For switching loads with a high inrush or overcurrent as transformers, motors or fluorescents, the maximum output current will limit to 2 A.



Product References

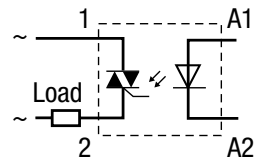
V DC 5-48 **CSS-I12X/DC5-48V**

Accessories

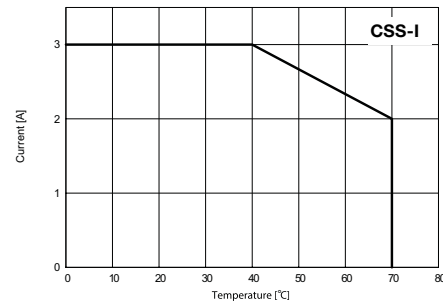
Socket **S10, S10-P**



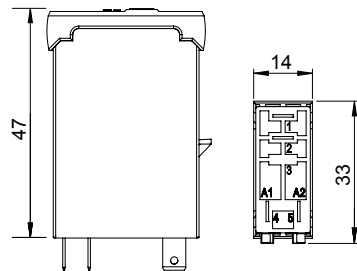
fig. 1 CSS-I diagram



Tab. 2 AC derating curve



Dimensions (mm)



Technical approvals, conformities



IEC/EN 60947

CSS-Z

1 pole | normally open solid state AC | Faston

Output	1 NO
Operating range	3 A, 24 ... 250 V AC, 50/60 Hz
Minimum contact load	35 mA

Contact

Type	1 NO (Solid state AC)
Material	Triac
Rated Load	3 A AC

Control circuit

Input voltage range	5 ... 48 V DC
Input current	10 mA

Output circuit

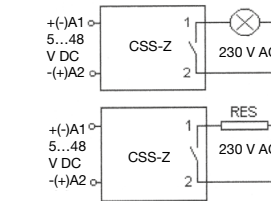
Max. output current	Synchronized zero
Min. output current	3 A
Output voltage range	24 ... 250 V AC
Inrush current	150 A/10 ms
Residual current	1 mA
I ^t value	210 A ² s

Specifications

Ambient temperature operation/storage	-40...70 °C / -40 ... 85 °C (no ice)
Pick-up time	10 ms
Release time	10 ms
Weight	28 g

Applications

Switches ohmic AC loads up to 3 A/250 V AC in the zero-point of the tension and avoids any over-current peak in the connection. Suitable for switching resistors, incandescent lamps, signalling equipment, etc. Not suitable for inductive loads



Product References

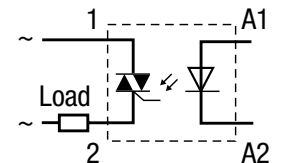
V DC 5-48 **CSS-Z12X/DC5-48V**

Accessories

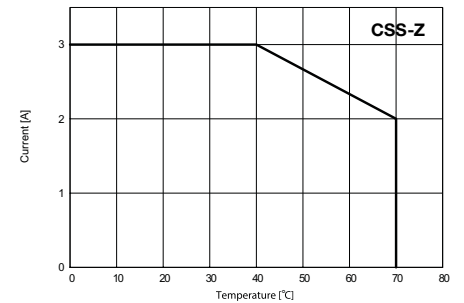
Socket **S10, S10-P**



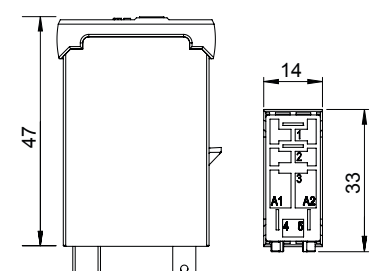
fig. 1 CSS-Z diagram



Tab. 2 AC derating curve



Dimensions (mm)



Technical approvals, conformities



IEC/EN 60947

CSS-N

1 pole | normally open solid state DC | Faston

Output	1 NO
Operating range	6 A, 5 ... 48 V DC
Minimum contact load	1 mA

Contact

Type	1 NO (Solid state AC)
Material	⚡ Triac
Rated Load	3 A AC

Control circuit

Input voltage range	5 ... 48 V DC
Input current	4 mA

Output circuit

Type	NPN
Max. output current	6 A
Output voltage range	5 ... 48 V DC
Max. inrush current	40 A / 10 ms
Max. voltage drop	≤ 0.14 V DC
Residual current	0.1 mA

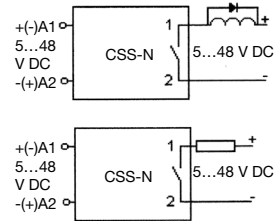
Specifications

Ambient temperature operation/storage	-40 ... 70 °C / -40 ... 85 °C (no ice)
Test voltage between input/output	4 kV rms / 1 min.
Turn-on delay	0.06 ms
Release delay	0.06 ms
Weight	28 g

Applications

For switching heating elements, electro valves, motors, PLC input/output signals, solenoids, incandescent and fluorescent lamps, etc. (up to 48 V DC).

Inductive loads must be shunted with an antiparallel diode.



Product References

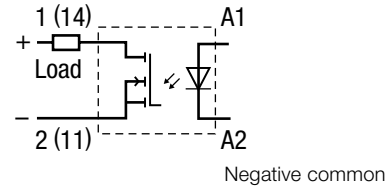
V DC 5-48 **CSS-N13X/DC5-48V**

Accessories

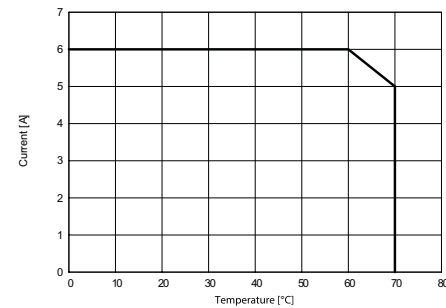
Socket **S10, S10-P**



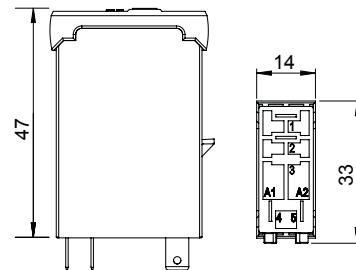
fig. 1 CSS-N diagram



Tab. 2 AC derating curve



Dimensions (mm)



Technical approvals, conformities



IEC/EN 60947

CSS-P

1 pole | normally open solid state DC | Faston

Output	1 NO
Operating range	6 A, 5 ... 48 V DC
Minimum contact load	1 mA

Contact

Type	1 NO (Solid state AC)
Material	⚡ Triac
Rated Load	3 A AC

Control circuit

Input voltage range	5 ... 48 V DC
Input current	4 mA

Output circuit

Type	PNP
Max. output current	6 A
Output voltage range	5 ... 48 V DC
Max. switch-on current	40 A / 10 ms
Max. voltage drop	0.14 V DC
Residual current	0.1 mA

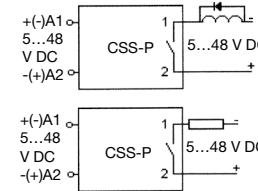
Specifications

Ambient temperature operation/storage	-40 ... 70 °C / -40 ... 85 °C (no ice)
Turn-on delay	0.06 ms
Release delay	0.06 ms
Weight	28 g

Applications

For switching heating elements, electro valves, motors, PLC input/output signals, solenoids, incandescent and fluorescent lamps, etc. (up to 48 V DC).

Inductive loads must be shunted with an antiparallel diode.



Product References

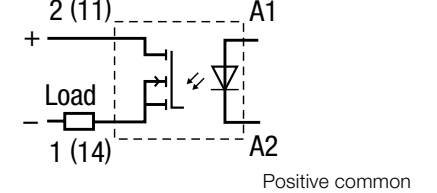
V DC 5-48 **CSS-P13X/DC5-48V**

Accessories

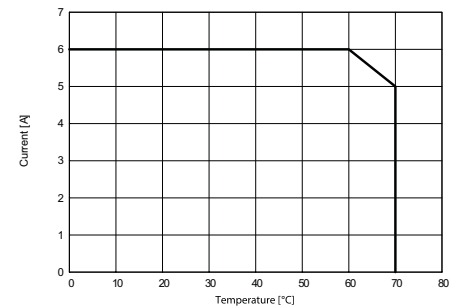
Socket **S10, S10-P**



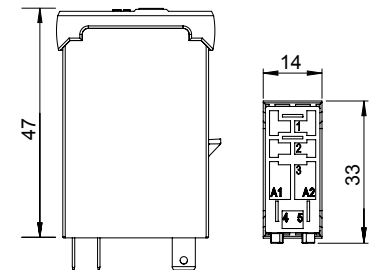
fig. 1 CSS-P diagram



Tab. 2 AC derating curve



Dimensions (mm)



Technical approvals, conformities



IEC/EN 60947

CRINT 1x5 series

1 pole | normally open solid state DC

Maximum contact load	2 A / 24 V DC-1
Recommended minimum contact load	20 mA / 5 V
Contact	
Type	1 NO (Solid state DC)
Material	Mosfet
Max. inrush current (10ms)	48 A

Coil	
Operation voltage DC	0.8 ... 1.25 U _N
Nominal power DC	160 mW

Insulation	
Test voltage I / O	2.5 kV rms / 1 min
Pollution degree	3
Over voltage category	III
Open contact	1000 Vrms dielectric strength 1 min
Standard	EN61810-5

Specifications	
Ambient temperature: operation / storage	-30 ... 70 °C / -40 ... 85 °C (no ice)
Typical response time @ V _n	1 ms
Typical release time @ V _n	1 ms
Cond. cross section screw terminal	2.5 mm ²
Cond. cross section spring cage	0.75 ... 2.5 mm ²
Protection degree	IP 20
Mounting position	any, TS-35 or Back Panel Mounting
Housing material	Polyamide PA 6

Product References	
Screw terminal	
DC 12V, 24V, 60V, 110-125V, 220-240V	CRINT-C115/DC...V

Cage clamp terminal	
DC 12V, 24V, 60V, 110-125V, 220-240V	CRINT-C125/DC...V

Railway EN 50155	CRINT-C125R/DC...V
„...“ List Coil Voltage to complete Product References	

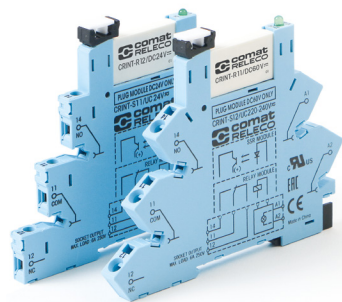
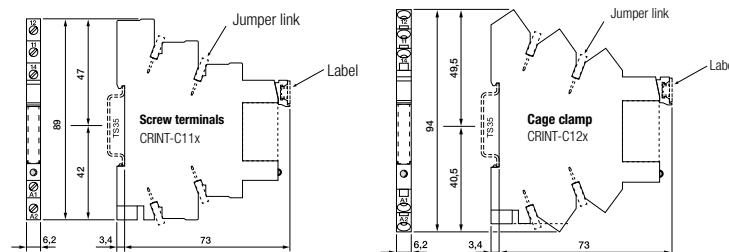
Accessories	
Jumper link	blue: CRINT-BR20-BU (BAG 5 PCS) red: CRINT-BR20-RD (BAG 5 PCS) black: CRINT-BR20-BK (BAG 5 PCS)

Label plate	CRINT-LAB (BAG 4x16 PCS)
Spacer	CRINT-SEP (BAG 5 PCS)

Replacement relays	
DC 12V, 24V, 48V, 60V*	CRINT-R15/DC...V

„...“ List Coil Voltage to complete Product References

*60V Relay used for all sockets with a nominal voltage higher or equal 60V



Connection diagram

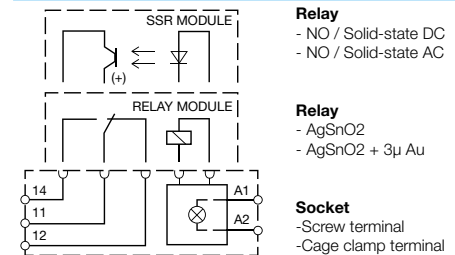


fig. 1 AC voltage endurance

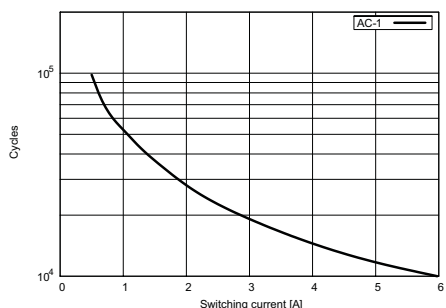
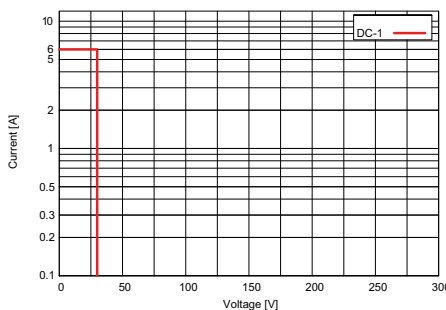


fig. 2 DC load limit curve



Dimensions (mm)

Technical approvals, conformities



IEC/EN 61810, IEC/EN 50155, IEC/EN 45545

CRINT 1x8 series

1 pole | normally open solid state AC

Maximum contact load	2 A
Recommended minimum contact load	20 mA / 5 V
Contact	
Type	1 NO (Solid state AC)
Material	Triac
Max. inrush current (10 ms)	80 A

Coil	
Operation voltage DC	0.8 ... 1.25 U _N
Nominal power DC	150 mW

Insulation	
Test voltage I / O	2.5 kV rms / 1 min
Pollution degree	3
Over voltage category	III
Open contact	1000 Vrms dielectric strength 1 min
Standard	EN61810-5

Specifications	
Ambient temperature: operation / storage	-30 ... 70 °C / -40 ... 85 °C (no ice)
Typical response time @ V _n	1 ms
Typical release time @ V _n	1 ms
Cond. cross section screw terminal	2.5 mm ²
Cond. cross section spring cage	0.75 ... 2.5 mm ²
Protection degree	IP 20
Mounting position	any, TS-35 or Back Panel Mounting
Housing material	Polyamide PA 6

Product References	
Screw terminal	
DC 12V, 24V, 60V, 110-125V, 220-240V	CRINT-C118/DC...V

Cage clamp terminal	
DC 12V, 24V, 60V, 110-125V, 220-240V	CRINT-C128/DC...V

Railway EN 50155	CRINT-C128R/DC...V
„...“ List Coil Voltage to complete Product References	

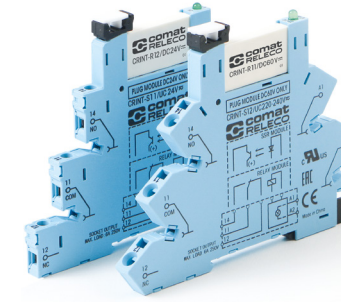
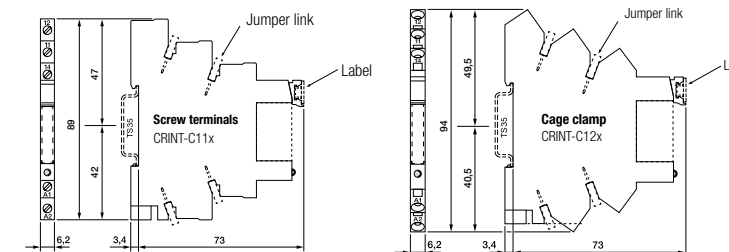
Accessories	
Jumper link	blue: CRINT-BR20-BU (BAG 5 PCS) red: CRINT-BR20-RD (BAG 5 PCS) black: CRINT-BR20-BK (BAG 5 PCS)

Label plate	CRINT-LAB (BAG 4x16 PCS)
Spacer	CRINT-SEP (BAG 5 PCS)

Replacement relays	
DC 12V, 24V, 60V*	CRINT-R18/DC...V

„...“ List Coil Voltage to complete Product References

*60V Relay used for all sockets with a nominal voltage higher or equal 60V



Connection diagram

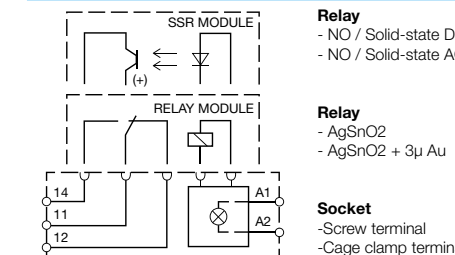


fig. 1 AC voltage endurance

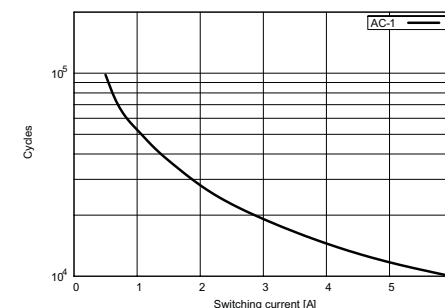
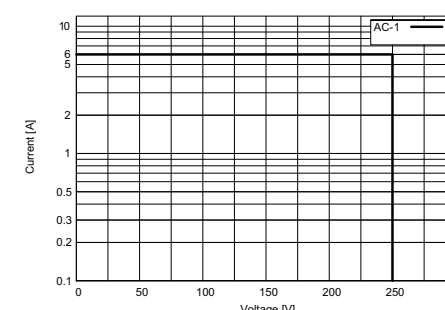


fig. 2 DC load limit curve



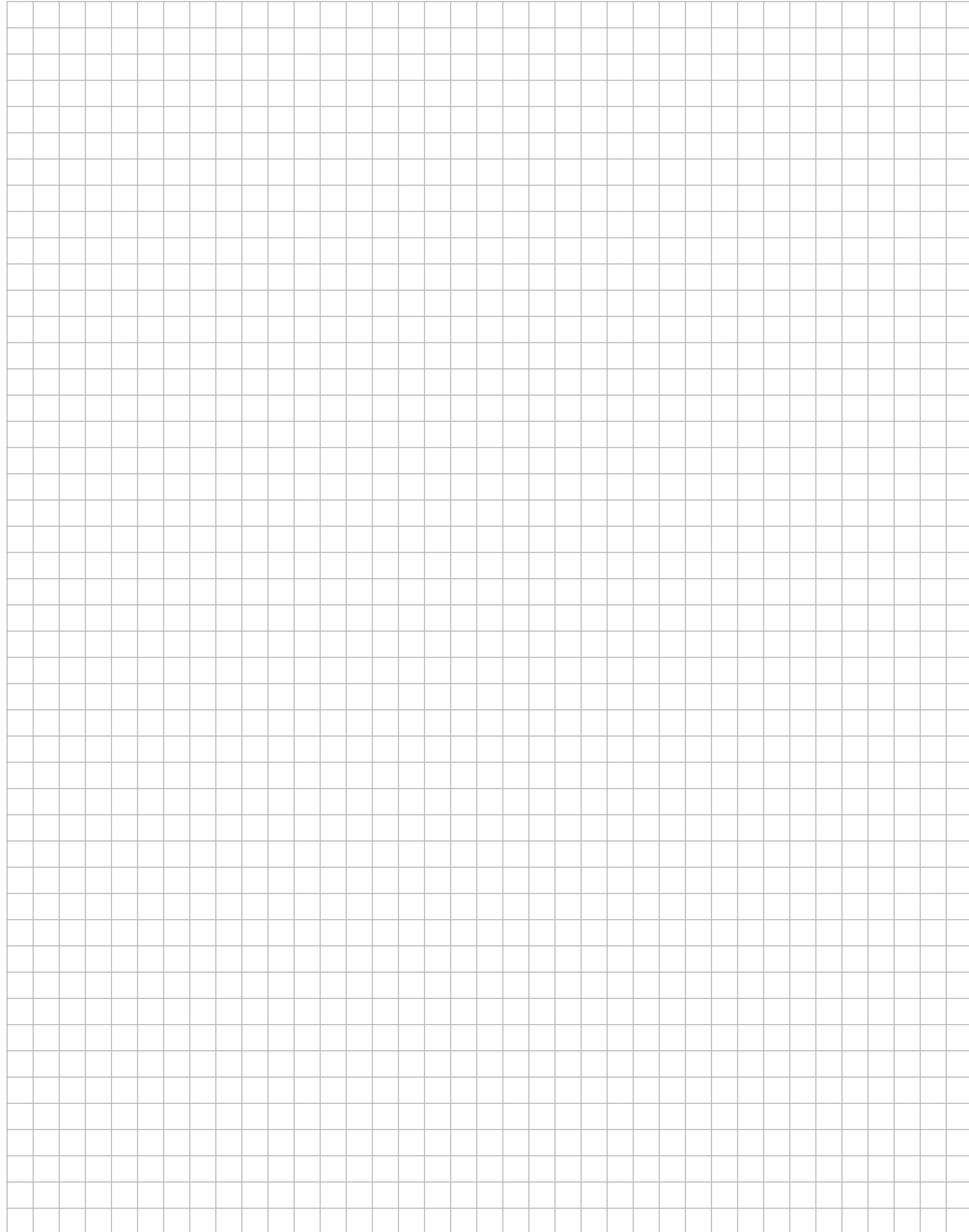
Dimensions (mm)

Technical approvals, conformities



IEC/EN 61810, IEC/EN 50155, IEC/EN 45545

Notes



1.6 Installation Relays

Application	Type	Page
CHI Series		
1 pole High Inrush Relay	CHI14	82
3 pole High Inrush Relay	CHI34	83
C100/200/300 Series		
2 pole Power Relay	C133.01	84
2 pole 2 Coil Control Relay	C203.01	85
2 pole 2 Coil Control Relay	C203.04	86
2 pole 2 Coil Signal Relay	C203.06	87
3 pole 3 Coil Signal Relay	C301.04	88
CR Series		
2 pole Signal Relay	CR11C	89
1 pole Power Relay	CR16CX	90
1 pole Power Relay Step Switch	CRS1C	91
B Series		
1 pole Power Relay	B103	92

CHI14

1 pole | High Inrush Relay

Maximum contact load	16 A / 250 V AC-1
Recommended minimum contact load	100 mA / 12 V

Contacts	
Number of contacts	1
Material	W / AgSnO ₂
Max. inrush current (20 ms)	165 A
(200 μs)	800 A / 200
Max. switching voltage AC-1	250 V
Max. AC load AC-1 fig. 1	4 kVA

Power supply- and control input	
Nominal voltage (A1, B1)	UC 24-240 V (UC = AC / DC)
Operating voltage range	16.8 ... 250 V
Power consumption	1.2 VA / 0.43 W
Frequency range	16 ... 60 Hz

Insulation	
Test voltage open contact	1 kV rms / 1 min
Test voltage between contacts and control input	2.5 kV rms / 1 min

General Specifications	
Ambient temperature storage /operation	-40 ... 85 °C / -40 ...60 °C (no ice)
Mechanical life of contact	5 x 1 000 000 operations
Conductor cross section	Stranded wire 2.5 mm ² , 2 x 1.5 mm ²
Protection degree	IP 20
Nominal screw torque	0.4 Nm
Housing material	Lexan
Weight	70 g

Product References	CHI14/UC24-240V
UC (AC/DC) 15...60 Hz	



Connection diagram

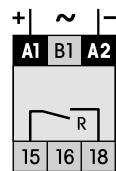


fig. 1 AC voltage endurance

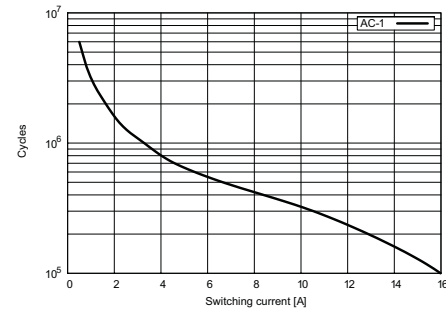
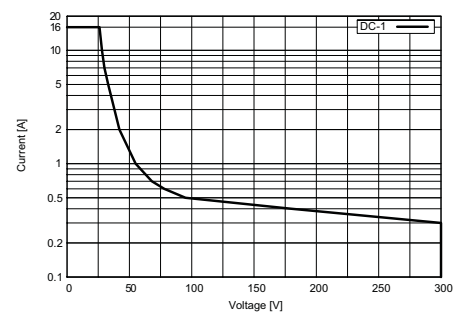
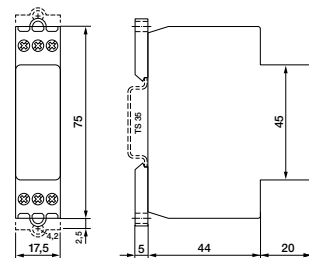


fig. 2 DC load limit curve



Dimensions (mm)



Technical approvals, conformities



CHI34

3 pole | High Inrush Relay

Maximum contact load	16 A / 250 V AC-1
Recommended minimum contact load	100 mA / 12 V

Contacts	
Number of contacts	3
Material	W / AgSnO ₂
Max. inrush current (20 ms)	165 A
(200 μs)	800 A
Max. switching voltage AC-1	250 V
Max. AC load AC-1 fig. 1	4 kVA

Auxiliary Contacts	
Number of contacts	1
Nominal current at 25° C/60° C	90 mA/60 mA
Inrush current	1 A/100 μs
Nominal voltage AC/DC	24 V
Contact Material	Semiconductor

Supply U_B (1-N)	
Nominal operating voltage (AC/DC)	110...240 V
Operating voltage (AC/DC)	80...250 V
Frequency range	47...63 Hz
Power consumption	3.45 VA

Power supply- and control input	
Nominal voltage (A1, A2)	UC 24-240 V (UC = AC / DC)
Operating voltage range	16.8 ... 250 V
Power consumption	30 VA / 30 mW
Frequency range	47...63 Hz

Insulation	
Test voltage open contact	1 kV rms / 1 min
Test voltage between contacts and control input	2.5 kV rms / 1 min
Test voltage between contacts	2.5 kV rms / 1 min

General Specifications	
Ambient temperature storage /operation	-40 ... 85 °C / -25 ...60 °C (no ice)
Mechanical life of contact	5 x 1 000 000 operations
Conductor cross section	Stranded wire 2.5 mm ² , 2 x 1.5 mm ²
Protection degree	IP 20
Nominal screw torque	0.6 Nm
Housing material	Lexan
Weight	125 g

Product References	CHI34/UC24-240V
UC (AC/DC) 47...63 Hz	



Connection diagram

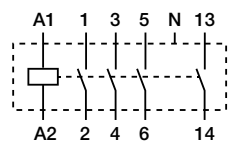


fig. 1 AC voltage endurance

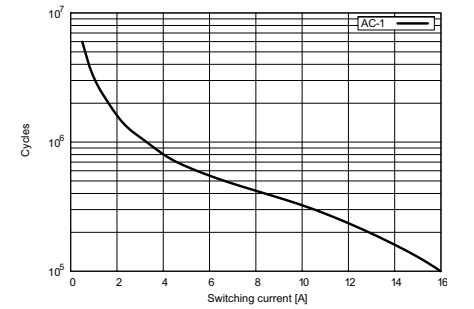
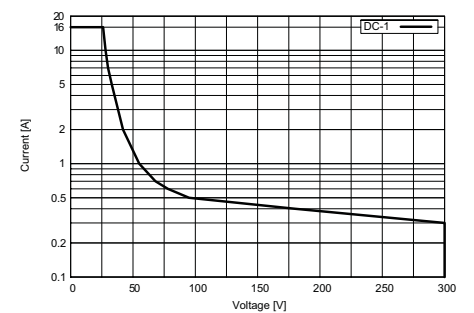
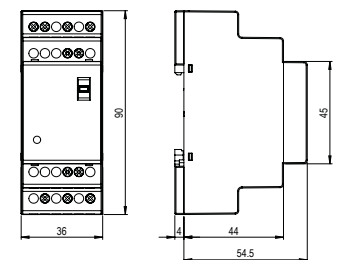


fig. 2 DC load limit curve



Dimensions (mm)



Technical approvals, conformities



C133.01

2 pole | Power Relay

Maximum contact load	6 A / 250 V AC-1
Recommended minimum contact load	100 mA / 12 V
Contacts	
Type	2 CO
Material	AgNi
Max. inrush current (20 ms)	15 A
Coil	
Operation voltage AC 50/60 Hz / DC	0.85 ... 1.15 U _N
Nominal power DC/AC	1.1 W / 1.1 VA
Insulation	
Test voltage I / O	2000 Vrms / 1min
Pollution degree	3
Over voltage category	III
Open contact	1000 Vrms
Standard	EN61810-1
Specifications	
Ambient temperature: operation / storage	-20 ... 55 °C / -40 ... 85 °C (no ice)
Typical response time @ V _n	10 ms
Typical release time @ V _n	10 ms
Cond. cross section screw terminal	2.5 mm ²
Protection degree	IP 20
Mounting position	any
Weight	89 g

Product References

AC220-240V, DC12V, UC24V, UC48V

"..." List Coil Voltage to complete Product References

C133.01/...V



Connection diagram

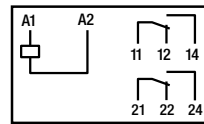
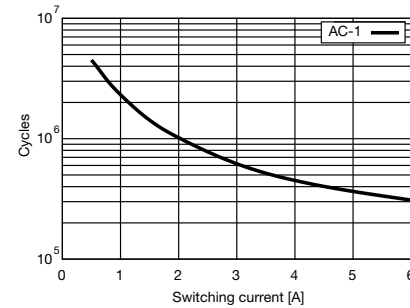
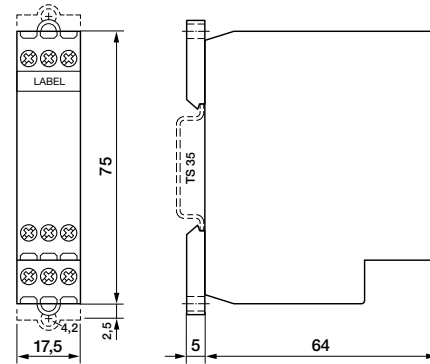


fig. 1 AC voltage endurance



Dimensions (mm)



Technical approvals, conformities



EN 61810

C203.01

2 pole | 2 Coil | Control Relay

Maximum contact load	6 A / 250 V AC-1	6 A 25 V DC-1
Recommended minimum contact load	100 mA / 12 V	
Contacts		
Type	2 x 1 CO	
Material	AgNi	
Max. inrush current (20 ms)	15 A	
Coil		
Operation voltage AC 50/60 Hz / DC	0.85 ... 1.15 U _N	
Nominal power DC/AC	1.1 W / 1.1 VA	
Insulation		
Test voltage I / O	2000 Vrms / 1min	
Pollution degree	3	
Over voltage category	III	
Open contact	1000 Vrms	
Standard	EN61810-1	
Specifications		
Ambient temperature: operation / storage	-20 ... 55 °C / -40 ... 85 °C (no ice)	
Typical response time @ V _n	10 ms	
Typical release time @ V _n	10 ms	
Cond. cross section screw terminal	2.5 mm ²	
Protection degree	IP 20	
Mounting position	any	
Weight	89 g	

Product References

AC220-240V, UC24V

"..." List Coil Voltage to complete Product References

C203.01/...V



Connection diagram

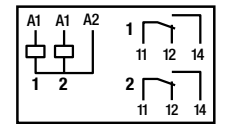
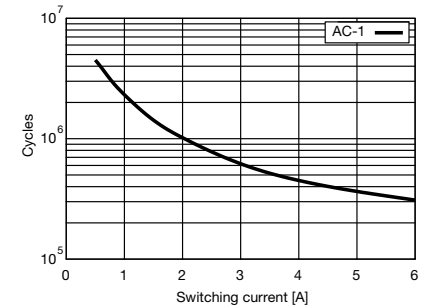
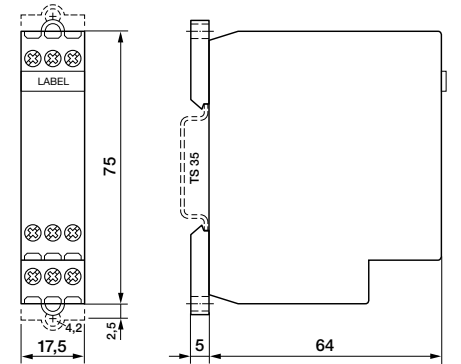


fig. 1 AC voltage endurance 250 V



Dimensions (mm)



Technical approvals, conformities



EN 61810

C203.04

2 pole | 2 Coil | Control Relay

Maximum contact load	5 A / 250 V AC-1	5 A 30 V DC-1
Recommended minimum contact load	1 mA / 0.1 V	

Contacts		
Type	2 CO	
Material	Ag Alloy	
Max. inrush current	-	

Coil		
Operation voltage DC	0.8 ... 1.2 U _N	
Nominal power DC	2 x 0.25 W	

Insulation		
Test voltage I / O	2000 Vrms / 1min	
Pollution degree	3	
Over voltage category	III	
Open contact	1000 Vrms	
Standard	EN61810-1	

Specifications		
Ambient temperature: operation / storage	-20 ... 55 °C / -40 ... 85 °C (no ice)	
Typical response time @ V _n	6 ms	
Typical release time @ V _n	30 ms	
Cond. cross section screw terminal	2.5 mm ²	
Protection degree	IP 20	
Mounting position	any	
Weight	65 g	

Product References
DC24V C203.04...V

"..." List Coil Voltage to complete Product References



Connection diagram

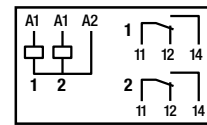
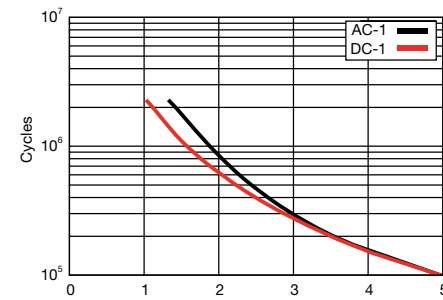
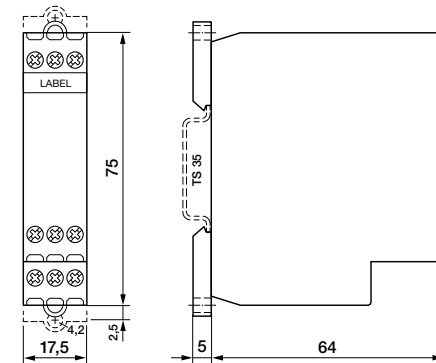


fig. 1 Contact endurance



Dimensions (mm)



Technical approvals, conformities



EN 61810

C203.06

2 pole | 2 Coil | Signal Relay

Maximum contact load	0.5 A / 125 V AC-1	2 A 30 V DC-1
Recommended minimum contact load	10 µA / 10 mV	

Contacts		
Type	2 x 1 CO	
Material	AgAu	
Max. inrush current	-	

Coil		
Operation voltage DC	0.8 ... 1.2 U _N	
Nominal power DC	2 x 0.25 W	

Insulation		
Test voltage I / O	2000 Vrms / 1min	
Pollution degree	3	
Over voltage category	III	
Open contact	1000 Vrms	
Standard	EN61810-1	

Specifications		
Ambient temperature: operation / storage	-20 ... 55 °C / -40 ... 85 °C (no ice)	
Typical response time @ V _n	10 ms	
Typical release time @ V _n	20 ms	
Cond. cross section screw terminal	2.5 mm ²	
Protection degree	IP 20	
Mounting position	any	
Weight	65 g	

Product References
AC220-240V, UC24V, UC48V C203.06/...V
UC24V C203.06R/...V

"..." List Coil Voltage to complete Product References



Connection diagram

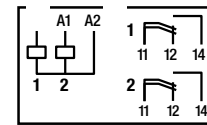


fig. 1 DC Voltage Endurance

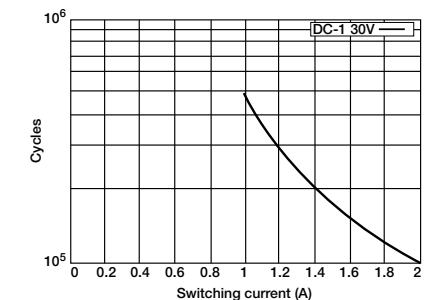
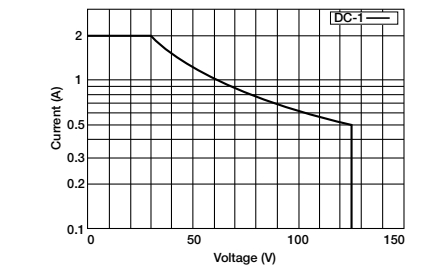
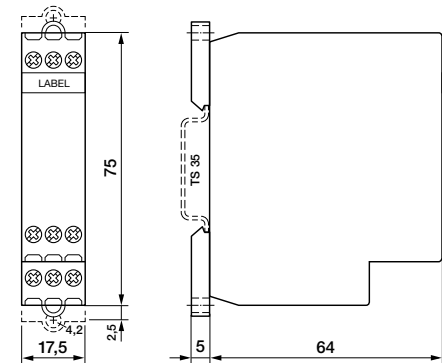


fig. 2 DC load limit curve



Dimensions (mm)



Technical approvals, conformities



EN 61810

C301.04

3 pole | 3 Coil | Signal Relay

Maximum contact load	5 A / 250 V AC-1	5 A 30 V DC-1
Recommended minimum contact load	1 mA / 0.1 V	

Contacts		
Type	3 x 1 NO	
Material	Ag Alloy	
Max. inrush current	-	

Coil		
Operation voltage DC	0.8 ... 1.2 U _N	
Nominal power DC	3 x 0.25 W	

Insulation		
Test voltage I / O	2000 Vrms / 1min	
Pollution degree	3	
Over voltage category	III	
Open contact	1000 Vrms	
Standard	EN61810-1	

Specifications		
Ambient temperature: operation / storage	-20 ... 55 °C / -40 ... 85 °C (no ice)	
Typical response time @ V _n	6 ms	
Typical release time @ V _n	30 ms	
Cond. cross section screw terminal	2.5 mm ²	
Protection degree	IP 20	
Mounting position	any	
Weight	65 g	

Product References	
DC24V	C301.04...V

"..." List Coil Voltage to complete Product References



Connection diagram

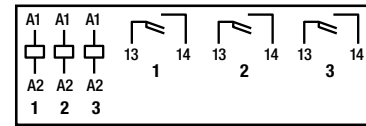
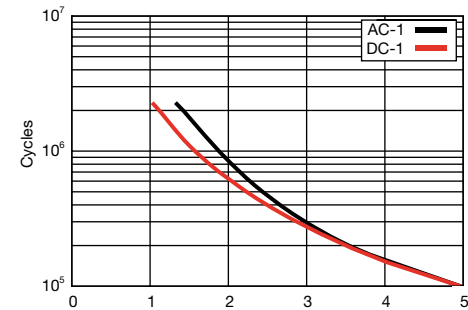
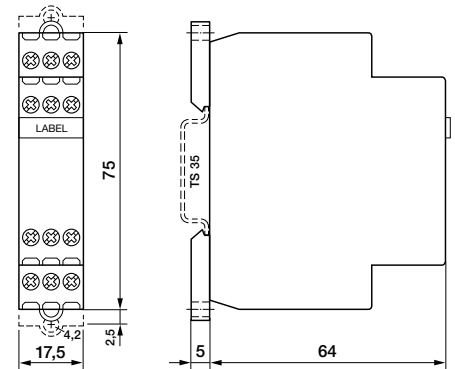


fig. 1 Contact endurance



Dimensions (mm)



Technical approvals, conformities



CR11C

2 pole | Signal Relay

Maximum contact load	0.5 A / 125 V AC-1	1 A 30 V DC-1
Recommended minimum contact load	10 μA / 10 mV	

Contacts		
Type	2 CO	
Material	AgAu	
Max. inrush current	-	

Coil		
Operation voltage DC	0.8 ... 1.2 U _N	
Nominal power DC	0.25 W	

Insulation		
Test voltage I / O	2000 Vrms / 1min	
Pollution degree	3	
Over voltage category	III	
Open contact	1000 Vrms	
Standard	EN61810-1	

Specifications		
Ambient temperature: operation / storage	-20 ... 55 °C / -40 ... 85 °C (no ice)	
Typical response time @ V _n	3 ms	
Typical release time @ V _n	4 ms	
Cond. cross section screw terminal	2.5 mm ²	
Protection degree	IP 20	
Mounting position	any	
Weight	38 g	

Product References	
DC24V	CR11C/...V

"..." List Coil Voltage to complete Product References



Connection diagram

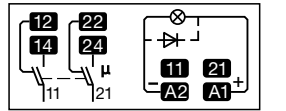
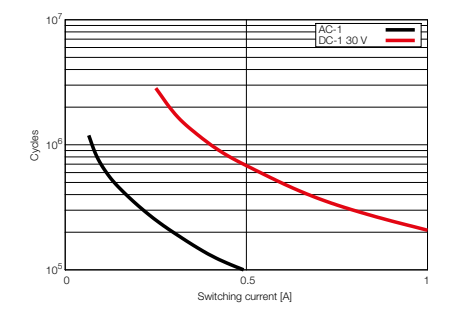
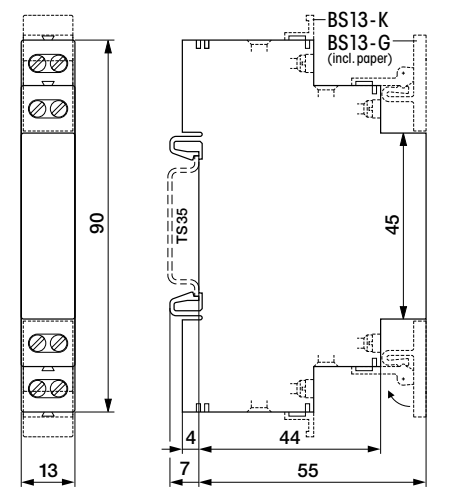


fig. 1 Contact endurance



Dimension



Technical approvals, conformities



CR16CX

1 pole | Power Relay

Maximum contact load	6 A / 250 V AC-1	6 A 30 V DC-1
Recommended minimum contact load	10 mA / 12 V	

Contacts		
Type	1 CO	
Material	⚡ AgNi	
Max. inrush current	-	

Coil		
Operation voltage AC / DC	0.8 ... 1.1 U _N / 0.85 ... 1.15 U _N	
Nominal power AC / DC	2.5 VA / 0.25 W	

Insulation		
Test voltage I / O	2000 Vrms / 1min	
Pollution degree	3	
Over voltage category	III	
Open contact	1000 Vrms	
Standard	EN61810-1	

Specifications		
Ambient temperature: operation / storage	-20 ... +60 °C / -40 ... 85 °C (no ice)	
Typical response time @ V _n	10 ms	
Typical release time @ V _n	20 ms	
Cond. cross section screw terminal	2.5 mm ²	
Protection degree	IP 20	
Mounting position	any	
Weight	45 g	

Product References	
DC24V, AC230V	CR16CX/...V

"..." List Coil Voltage to complete Product References



Connection diagram

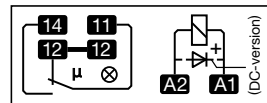
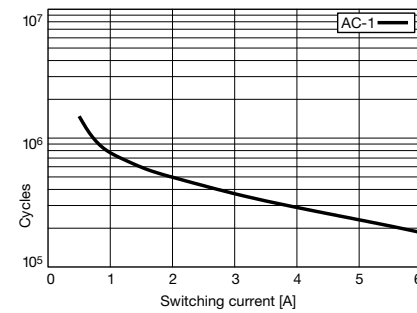
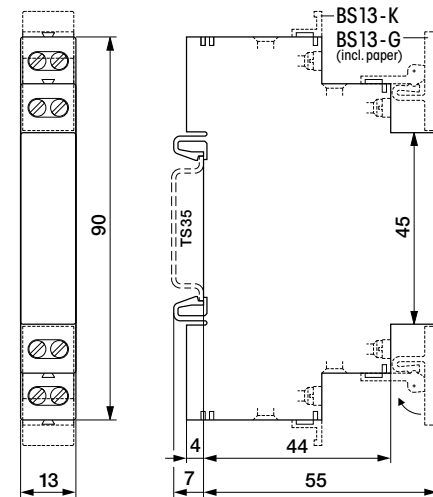


fig. 1 AC voltage endurance 250 V



Dimensions (mm)



Technical approvals, conformities



IEC 61810

CRS1C

1 pole | Power Relay | Step Switch

Maximum contact load	6 A / 250 V AC-1	6 A 30 V DC-1
Recommended minimum contact load	10 mA / 12 V	

Contacts		
Type	1 CO	
Material	⚡ AgNi	
Max. inrush current	-	

Coil		
Operation voltage AC / DC	0.85 ... 1.15 U _N / 0.85 ... 1.15 U _N	
Nominal power AC / DC	2 VA / 1.5 W	

Insulation		
Test voltage I / O	2000 Vrms / 1min	
Pollution degree	3	
Over voltage category	III	
Open contact	1000 Vrms	
Standard	EN61810-1	

Specifications		
Ambient temperature: operation / storage	-20 ... +60 °C / -40 ... 85 °C (no ice)	
Typical response time @ V _n	≥ 50 ms	
Typical release time @ V _n	≥ 50 ms	
Cond. cross section screw terminal	2.5 mm ²	
Protection degree	IP 20	
Mounting position	any	
Weight	45 g	

Product References	
DC24V, AC230V	CRS1C/...V

"..." List Coil Voltage to complete Product References



Connection diagram

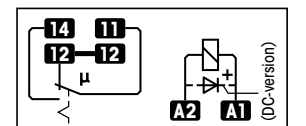
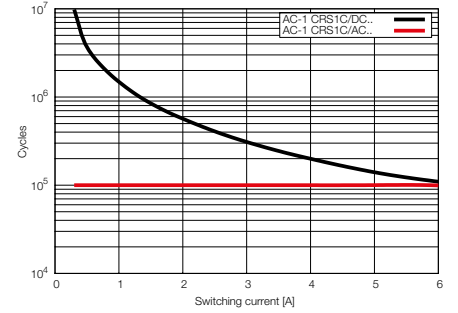
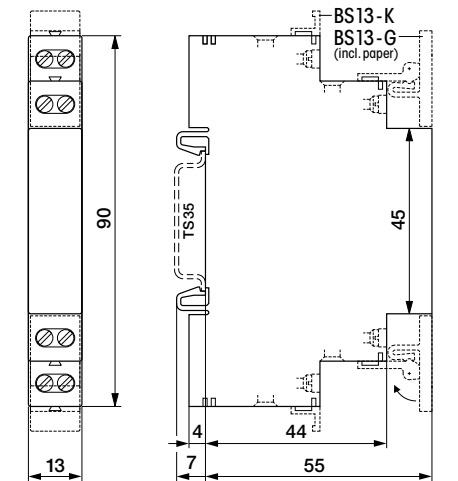


fig. 1 AC voltage endurance 250 V



Dimension



Technical approvals, conformities



IEC 61810

B103

1 pole | Power Relay

Maximum contact load	10 A / 250 V AC-1	6 A 30 V DC-1
Recommended minimum contact load	10 mA / 12 V	

Contacts		
Type	1 CO	
Material	⚡ AgSnO ₂	
Max. inrush current (20 ms)	16 A	

Coil		
Operation voltage AC / DC	0.85 ... 1.15 U _N / 0.85 ... 1.15 U _N	
Nominal power AC / DC	0.5 ... 5.5 VA / 1.2 W	

Insulation		
Test voltage I / O	2000 Vrms / 1min	
Pollution degree	3	
Over voltage category	III	
Open contact	1000 Vrms	
Standard	EN61810-1	

Specifications		
Ambient temperature: operation / storage	-20 ... 55 °C / -40 ... 85 °C (no ice)	
Typical response time @ V _n	20 ms	
Typical release time @ V _n	12 ms	
Cond. cross section screw terminal	2.5 mm ²	
Protection degree	IP 20	
Mounting position	any	
Weight	60 g	

Product References		
AC220-240V, UC8-12V, UC24V	B103/...V	
"... " List Coil Voltage to complete Product References		



Connection diagram

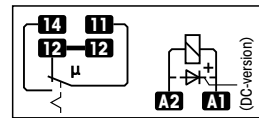


fig. 1 AC voltage endurance 250 V

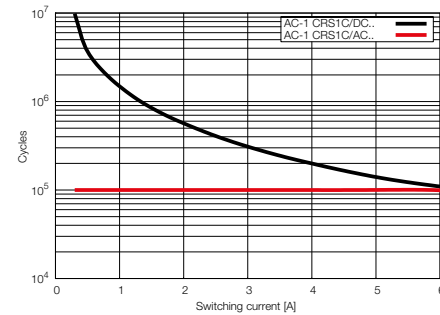
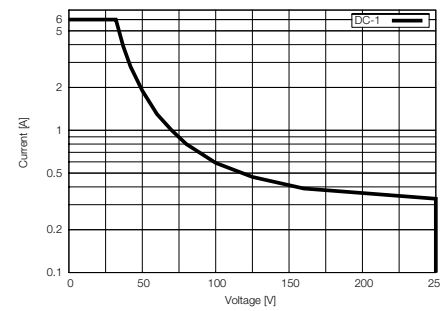
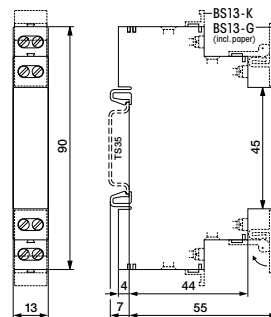


fig. 2 DC load limit curve



Dimensions (mm)



Technical approvals, conformities



IEC 61810



1.7 Installation Contactors

Application	Type	Page
RIC Series		
Installation Contactor 1, 2 or 4 pole 16 A 3.5 kW	RIC16	94
Installation Contactor 2 pole 20 A 4 kW	RIC20	95
Installation Contactor 2 pole 20 A 7 kW Railway	RIC20-xxx-R4A	96
Installation Contactor 2 or 4 pole 25 A 5.4 kW	RIC25	97
Installation Contactor 2 or 4 pole 32 A 7 kW	RIC32	98
Installation Contactor 4 pole 40 A 8.7 kW	RIC40	99
Installation Contactor 4 pole 63 A 13.3 kW	RIC63	100
RAC Series – manual lever Auto – 1 – Lock		
Installation Contactor 2 pole 20 A 4 kW	RAC20	101
Installation Contactor 2 pole 25 A 5.4 kW	RAC25	102
Installation Contactor 4 pole 40 A 8.7 kW	RAC40	103
Installation Contactor 4 pole 63 A 13.3 kW	RAC63	104
RBC Series – Step switch – manual lever 0 – 1 – Lock		
Installation Contactor 2 or 4 pole 20 A 4.4 kW	RBC20	105
Installation Contactor 4 pole 32 A 7 kW	RBC32	106
Accessories		
Auxiliary module 2 pole 6 A	RIC-AUX	107
Auxiliary module 2 pole 6 A	RBC-AUX	108
Auxiliary centralized control On – Off	RBC-AUX-CM	109
Auxiliary group control On – Off	RBC-AUX-GM	110
Spacer	RIC-DIST	111
Sealing cover	RIC-SEAL	112

RIC16

Installation Contactor | 1, 2 or 4 pole | 16 A | 3.5kW

Main circuit

Contact material	AgNi
Rated voltage	400 V
Rated current AC-1	16 A
Minimum contact load	50 mA, 17 V
Inrush current	50 A, 100 ms
Rated load AC-1, 230 V	3.5 kW
Rated load AC-3, 230 V	1.1 kW (NO) / 0.55 kW (NC)
Rated load DC-1, DC-3, DC-5	fig. 2
Mechanical endurance (cycles)	≥ 1 x 10 ⁷
Electrical endurance at rated load AC-1 (cycles)	≥ 2 x 10 ⁵
Electrical endurance at rated load AC-3 (cycles)	≥ 3 x 10 ⁵
Electrical endurance at rated load DC-1 (cycles)	≥ 1 x 10 ⁵
Switching frequency at rated load AC-1 (cycles/h)	≤ 600
Switching frequency at rated load AC-3 (cycles/h)	≤ 600
Switching frequency at rated load DC-1 (cycles/h)	≤ 300

Control circuit

Nominal voltage	230 V UC
Operating voltage range	0.85 ... 1.1 U _N
Typ. pick-up voltage	≤ 0.85 U _N
Typ. release voltage	≥ 0.1 U _N
Pick-up time	15 ... 45 ms
Release time	20 ... 50 ms
Power consumption AC / DC	2.1 VA / 2.1 W
Rated frequency	40 ... 500 Hz

Insulation

Rated insulation voltage	440 V
Rated impulse withstand voltage open contact	4 kV
Pollution degree	3
Overvoltage category	III
Clearance of open contact	3.6 mm

General data

Ambient temperature storage	-30 ... 80 °C
Ambient temperature operation 2 Device / 1 Spacer	-15 ... 55 °C
Ambient temperature operation 3 Device / 1 Spacer	-15 ... 40 °C
Conductor cross section Control / Main Circuit	2.5 mm ² / 6 mm ²
Nominal screw torque Control / Main Circuit	0.6 Nm / 3.5 Nm
Module width	fig. 3
Weight	130 g (1, 2 pole) / 170 g (4 pole)
Protection degree	IP 20
Housing material	PA 6

Product references

Main circuit	Product reference	230
1 NO	RIC16-100/UC...V	✓
1 NC	RIC16-010/UC...V	✓
1 NO + 1 NC	RIC16-110/UC...V	✓
2 NO	RIC16-200/UC...V	✓
2 NC	RIC16-020/UC...V	✓
2 NO + 2 NC	RIC16-220/UC...V	✓
3 NO + 1 NC	RIC16-310/UC...V	✓
4 NO	RIC16-400/UC...V	✓
4 NC	RIC16-040/UC...V	✓

"..." list control circuit voltage to complete product references.
Other voltages on request. Please contact support@comatreleco.com.

Accessories

Sealing cover	RIC-SEAL20 / RIC-SEAL25
Spacer	RIC-DIST



fig. 1. Wiring diagram

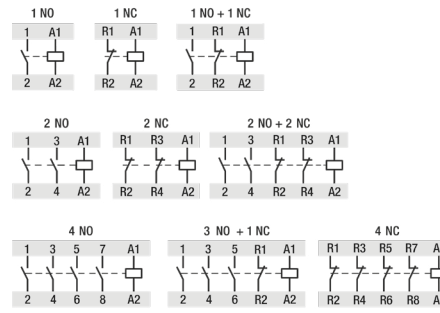


fig. 2. DC load limit curve

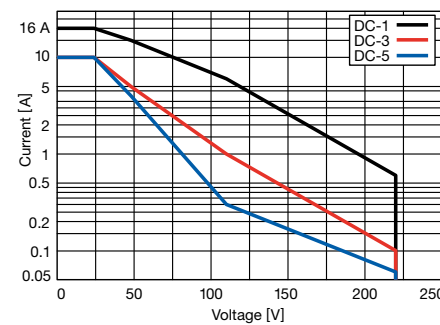
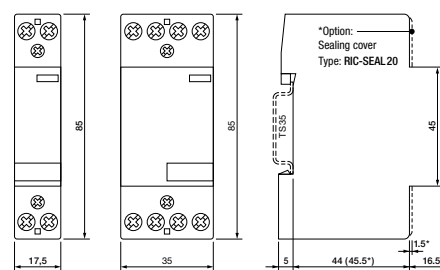


fig. 3. Dimensions (mm)



Standards and approvals

Standards IEC/EN 60947, IEC/EN 61095



Approvals

RIC20

Installation Contactor | 2 pole | 20 A | 4 kW

Main circuit

Contact material	AgNi
Rated voltage	400 V
Rated current AC-1	20 A
Minimum contact load	50 mA, 17 V
Inrush current	50 A, 100 ms / 180 A, 300 μs
Rated load AC-1, 230 V	4 kW
Rated load AC-3, 230 V	1.3 kW (NO) / 0.75 kW (NC)
Rated load DC-1, DC-3, DC-5	fig. 2
Mechanical endurance (cycles)	≥ 1 x 10 ⁷
Electrical endurance at rated load AC-1 (cycles)	≥ 2 x 10 ⁵
Electrical endurance at rated load AC-3 (cycles)	≥ 3 x 10 ⁵
Electrical endurance at rated load DC-1 (cycles)	≥ 1 x 10 ⁵
Switching frequency at rated load AC-1 (cycles/h)	≤ 600
Switching frequency at rated load AC-3 (cycles/h)	≤ 600
Switching frequency at rated load DC-1 (cycles/h)	≤ 300

Control circuit

Nominal voltage	24V UC, 36 V UC, 110 V UC, 230 V UC
Operating voltage range	0.85 ... 1.1 U _N
Typ. pick-up voltage	≤ 0.85 U _N
Typ. release voltage	≥ 0.1 U _N
Pick-up time	15 ... 45 ms
Release time	20 ... 50 ms
Power consumption AC / DC	2.1 VA / 2.1 W
Rated frequency	40 ... 500 Hz

Insulation

Rated insulation voltage	440 V
Rated impulse withstand voltage open contact	4 kV
Pollution degree	3
Overvoltage category	III
Clearance of open contact	3.6 mm

General data

Ambient temperature storage	-30 ... 80 °C
Ambient temperature operation 2 Device / 1 Spacer	-15 ... 55 °C
Ambient temperature operation 3 Device / 1 Spacer	-15 ... 40 °C
Conductor cross section Control / Main Circuit	2.5 mm ² / 6 mm ²
Nominal screw torque Control / Main Circuit	0.6 Nm / 1.2 Nm
Module width	fig. 3
Weight	130 g
Protection degree	IP 20
Housing material	PA 6

Product references

Main circuit	Product reference	24	36	110	230
2 NO	RIC20-200/UC...V	✓	✓	✓	✓
2 NC	RIC20-020/UC...V	✓	✓	✓	✓
1 NO + 1 NC	RIC20-110/UC...V	✓	✓	✓	✓

"..." list control circuit voltage to complete product references.
Other voltages on request. Please contact support@comatreleco.com.

Accessories

Sealing cover	RIC-SEAL20
Spacer	RIC-DIST

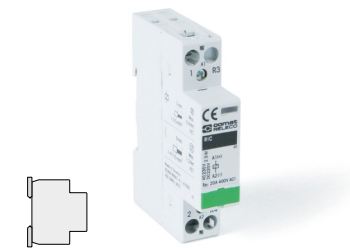


fig. 1. Wiring diagram

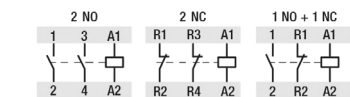


fig. 2. DC load limit curve

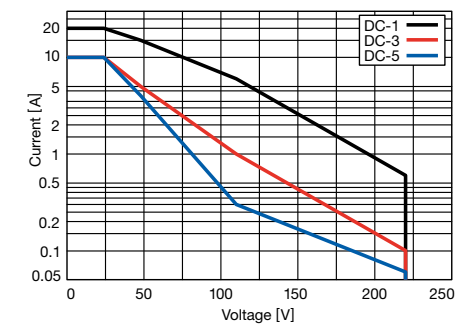
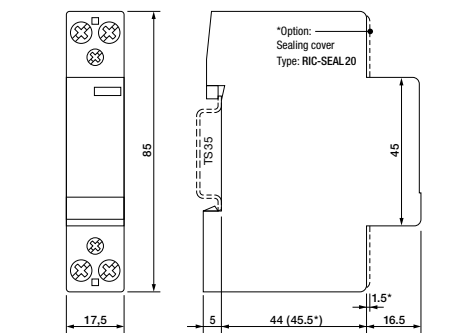


fig. 3. Dimensions (mm)



Standards and approvals

Standards IEC/EN 60947, IEC/EN 61095



Approvals

RIC20-xxx-R4A110V

Installation Contactor | 2 pole | 20 A | 7 kW

Main circuit

Contact material	AgNi
Rated voltage	400 V
Rated current AC-1	20 A
Minimum contact load	50 mA, 17 V
Inrush current	50 A, 100 ms / 180 A, 300 μs
Rated load AC-1, 230 V	7 kW
Rated load AC-3, 230 V	1.3 kW (NO) / 0.75 kW (NC)
Rated load DC-1, DC-3, DC-5	fig. 2
Mechanical endurance (cycles)	≥ 1 x 10 ⁷
Electrical endurance at rated load AC-1 (cycles)	≥ 1.5 x 10 ⁵
Electrical endurance at rated load AC-3 (cycles)	≥ 2 x 10 ⁵
Electrical endurance at rated load DC-1 (cycles)	≥ 2 x 10 ⁵
Electrical endurance at rated load DC-5 (cycles)	≥ 3 x 10 ⁵
Switching frequency at rated load AC-1 (cycles/h)	≤ 600
Switching frequency at rated load AC-3 (cycles/h)	≤ 600
Switching frequency at rated load DC-3 (cycles/h)	≤ 300
Switching frequency at rated load DC-5 (cycles/h)	≤ 300

Control circuit

Nominal voltage	24 V DC, 36 V DC, 72V DC, 110 V DC
Operating voltage range	0.70 ... 1.25 U _N
Typ. pick-up voltage	≤ 0.7 U _N
Typ. release voltage	≥ 0.1 U _N
Pick-up time	15 ... 45 ms
Release time	20 ... 50 ms
Power consumption DC	2.6 W

Insulation

Rated insulation voltage	440 V
Rated impulse withstand voltage open contact	4 kV
Pollution degree	3
Overvoltage category	III
Clearance of open contact	3.6 mm

General data

Ambient temperature storage	-40 ... 80 °C
Ambient temperature operation	-40 ... 70 °C
Conductor cross section Control / Main Circuit	2.5 mm ² / 6 mm ²
Nominal screw torque Control / Main Circuit	0.6 Nm / 1.2 Nm
Module width	fig. 3
Weight	135 g
Protection degree	IP 20
Housing material	PA 6
Spacer	Integrated

Product references

Main circuit	Product reference	24	36	72	110
2 NO	RIC20-200-R4A110V/DC...V	✓	✓	✓	✓
2 NC	RIC20-020-R4A110V/DC...V	✓	✓	✓	✓
1 NO + 1 NC	RIC20-110-R4A110V/DC...V	✓	✓	✓	✓

"..." list control circuit voltage to complete product references.
Other voltages on request. Please contact support@comatreleco.com.

Accessories

Sealing cover	RIC-SEAL20
---------------	------------

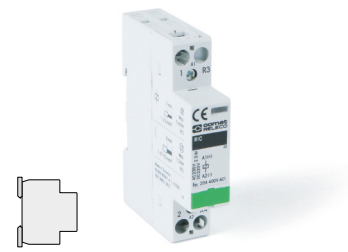


fig. 1. Wiring diagram

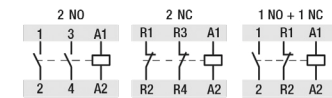


fig. 2. DC load limit curve

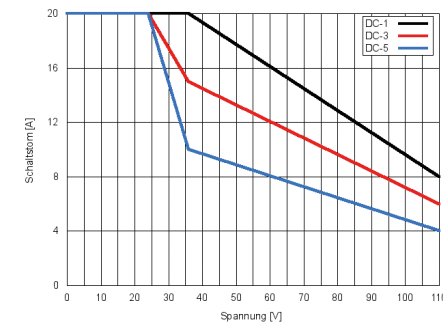
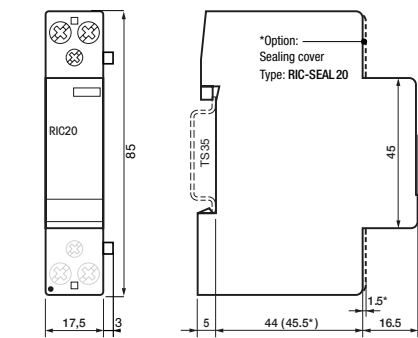
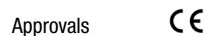


fig. 3. Dimensions (mm)



Standards and approvals

Standards IEC/EN 50155, IEC/EN 61373, IEC/EN 45545-2, IEC/EN 60947



RIC25

Installation Contactor | 2 or 4 pole | 25 A | 5.4 kW

Main circuit

Contact material	AgNi
Rated voltage	400 V
Rated current AC-1	25 A
Minimum contact load	50 mA, 17 V
Inrush current	60 A, 100 ms / 280 A, 300 μs
Rated load AC-1, 230 V	5.4 kW
Rated load AC-3, 230 V	1.3 kW
Rated load DC-1, DC-3, DC-5	fig. 2
Mechanical endurance (cycles)	≥ 1 x 10 ⁷
Electrical endurance at rated load AC-1 (cycles)	≥ 2 x 10 ⁵
Electrical endurance at rated load AC-3 (cycles)	≥ 5 x 10 ⁷
Electrical endurance at rated load DC-1 (cycles)	≥ 1 x 10 ⁵
Switching frequency at rated load AC-1 (cycles/h)	≤ 600
Switching frequency at rated load AC-3 (cycles/h)	≤ 600
Switching frequency at rated load DC-1 (cycles/h)	≤ 300

Control circuit

Nominal voltage	48 V AC, 400 V AC 24 V UC, 36 V UC, 110 V UC, 230 V UC
Operating voltage range	0.85 ... 1.1 U _N
Typ. pick-up voltage	≤ 0.85 U _N
Typ. release voltage	≥ 0.1 U _N
Pick-up time	15 ... 45 ms
Release time	20 ... 70 ms
Power consumption AC / DC	2.6 VA / 2.6 W
Rated frequency	50 / 60 Hz 40 ... 500Hz

Insulation

Rated insulation voltage	440 V
Rated impulse withstand voltage open contact	4 kV
Pollution degree	3
Overvoltage category	III
Clearance of open contact	3.6 mm

General data

Ambient temperature storage	-30 ... 80 °C
Ambient temperature operation 2 Device / 1 Spacer	-15 ... 55 °C
Ambient temperature operation 3 Device / 1 Spacer	-15 ... 40 °C
Conductor cross section Control / Main Circuit	2.5 mm ² / 6 mm ²
Nominal screw torque Control / Main Circuit	0.6 Nm / 1.2 Nm
Module width	fig. 3
Weight	250 g
Protection degree	IP 20
Housing material	PA 6

Product references

Main circuit	Product reference	48	400	24	36	72	110	230
4 NO	RIC25-400/AC...V	✓	✓					
4 NC	RIC25-040/AC...V		✓					
4 NO	RIC25-400/UC...V			✓	✓			✓
4 NC	RIC25-040/UC...V			✓	✓	✓		✓
2 NO + 2 NC	RIC25-220/UC...V			✓	✓	✓	✓	✓
2 CO	RIC25-002/UC...V			✓				✓

"..." list control circuit voltage to complete product references.
Other voltages on request. Please contact support@comatreleco.com.

Accessories

Auxiliary module	RIC-AUX
Sealing cover	RIC-SEAL25
Spacer	RIC-DIST

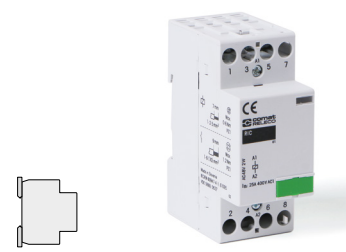


fig. 1. Wiring diagram

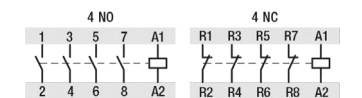
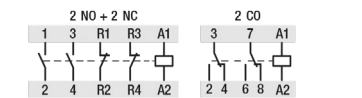


fig. 2. DC load limit curve

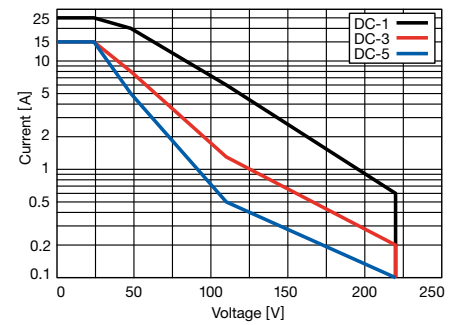
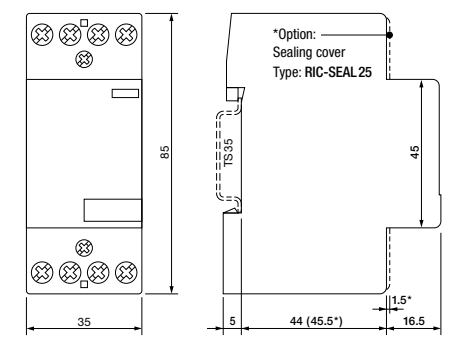


fig. 3. Dimensions (mm)



Standards and approvals

Standards IEC/EN 60947, IEC/EN 61095



RIC32

Installation Contactor | 2 or 4 pole | 32 A | 7 kW

Main circuit

Contact material	AgNi
Rated voltage	400 V
Rated current AC-1	32 A
Minimum contact load	50 mA, 17 V
Inrush current	60 A, 100 ms
Rated load AC-1, 230 V	7 kW
Rated load AC-3, 230 V	1.3 kW
Rated load DC-1, DC-3, DC-5	fig. 2
Mechanical endurance (cycles)	≥ 1 x 10 ⁷
Electrical endurance at rated load AC-1 (cycles)	≥ 2 x 10 ⁵
Electrical endurance at rated load AC-3 (cycles)	≥ 5 x 10 ⁵
Electrical endurance at rated load DC-1 (cycles)	≥ 1 x 10 ⁵
Switching frequency at rated load AC-1 (cycles/h)	≤ 600
Switching frequency at rated load AC-3 (cycles/h)	≤ 600
Switching frequency at rated load DC-1 (cycles/h)	≤ 300

Control circuit

Nominal voltage	230 V UC
Operating voltage range	0.85 ... 1.1 U _N
Typ. pick-up voltage	≤ 0.85 U _N
Typ. release voltage	≥ 0.1 U _N
Pick-up time	15 ... 45 ms
Release time	20 ... 70 ms
Power consumption AC / DC	2.6 VA / 2.6 W
Rated frequency	40 ... 500Hz

Insulation

Rated insulation voltage	440 V
Rated impulse withstand voltage open contact	4 kV
Pollution degree	3
Overvoltage category	III
Clearance of open contact	3.6 mm

General data

Ambient temperature storage	-30 ... 80 °C
Ambient temperature operation 2 Device / 1 Spacer	-15 ... 55 °C
Ambient temperature operation 3 Device / 1 Spacer	-15 ... 40 °C
Conductor cross section Control / Main Circuit	2.5 mm ² / 6 mm ²
Nominal screw torque Control / Main Circuit	0.6 Nm / 1.2 Nm
Module width	fig. 3
Weight	140 g (2 pole) / 250 g (4 pole)
Protection degree	IP 20
Housing material	PA 6

Product references

Main circuit	Product reference	230
2 NO	RIC32-200/UC...V	✓
2 NC	RIC32-020/UC...V	✓
1 NO + 1 NC	RIC32-110/UC...V	✓
4 NO	RIC32-400/UC...V	✓
4 NC	RIC32-040/UC...V	✓
2 NO + 2 NC	RIC32-220/UC...V	✓
3 NO + 1 NC	RIC32-310/UC...V	✓

"..." list control circuit voltage to complete product references.
Other voltages on request. Please contact support@comatreleco.com.

Accessories

Auxiliary module	RIC-AUX
Sealing cover	RIC-SEAL20 / RIC-SEAL25
Spacer	RIC-DIST



fig. 1. Wiring diagram

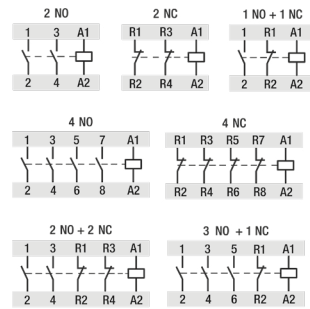


fig. 2. DC load limit curve

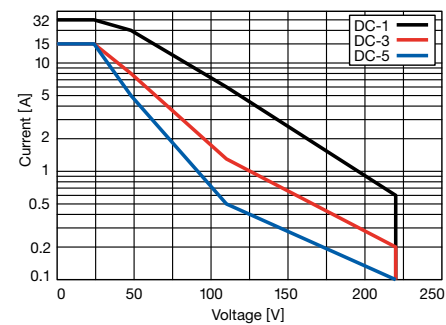
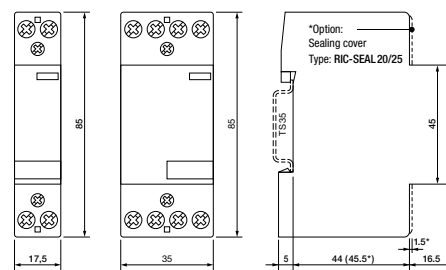


fig. 3. Dimensions (mm)



Standards and approvals

Standards IEC/EN 60947, IEC/EN 61095



RIC40

Installation Contactor | 4 pole | 40 A | 8.7 kW

Main circuit

Contact material	AgSnO ₂
Rated voltage	400 V
Rated current AC-1	40 A
Minimum contact load	50 mA, 17 V
Inrush current	170 A, 100 ms / 970 A, 300 μs
Rated load AC-1, 230 V	8.7 kW
Rated load AC-3, 230 V	3.7 kW
Rated load DC-1, DC-3, DC-5	fig. 2
Mechanical endurance (cycles)	≥ 1 x 10 ⁷
Electrical endurance at rated load AC-1 (cycles)	≥ 1 x 10 ⁵
Electrical endurance at rated load AC-3 (cycles)	≥ 1.5 x 10 ⁵
Electrical endurance at rated load DC-1 (cycles)	≥ 1 x 10 ⁵
Switching frequency at rated load AC-1 (cycles/h)	≤ 600
Switching frequency at rated load AC-3 (cycles/h)	≤ 600
Switching frequency at rated load DC-1 (cycles/h)	≤ 300

Control circuit

Nominal voltage	230 V AC	24 V UC, 48 V UC, 230 V UC
Operating voltage range	0.85 ... 1.1 U _N	
Typ. pick-up voltage	≤ 0.85 U _N	
Typ. release voltage	≥ 0.1 U _N	
Pick-up time	15 ... 20 ms	
Release time	35 ... 45 ms	
Power consumption AC / DC	5 VA / 5 W	
Rated frequency	50 / 60 Hz	40 ... 500 Hz

Insulation

Rated insulation voltage	440 V
Rated impulse withstand voltage open contact	6 kV
Pollution degree	3
Overvoltage category	III
Clearance of open contact	3.6 mm

General data

Ambient temperature storage	-30 ... 80 °C
Ambient temperature operation 2 Device / 1 Spacer	-15 ... 55 °C
Ambient temperature operation 3 Device / 1 Spacer	-15 ... 40 °C
Conductor cross section Control / Main Circuit	2.5 mm ² / 16 mm ²
Nominal screw torque Control / Main Circuit	0.6 Nm / 3.5 Nm
Module width	fig. 3
Weight	420 g
Protection degree	IP 20
Housing material	PA 6

Product references

Main circuit	Product reference	230	24	48
4 NC	RIC40-040/AC...V	✓		
4 NO	RIC40-400/UC...V	✓	✓	
4 NC	RIC40-040/UC...V	✓	✓	
4 NC	RIC40-040/UC...V	✓	✓	✓
2 NO + 2 NC	RIC40-220/UC...V	✓	✓	✓

"..." list control circuit voltage to complete product references.
Other voltages on request. Please contact support@comatreleco.com.

Accessories

Auxiliary module	RIC-AUX
Sealing cover	RIC-SEAL40/63
Spacer	RIC-DIST



fig. 1. Wiring diagram

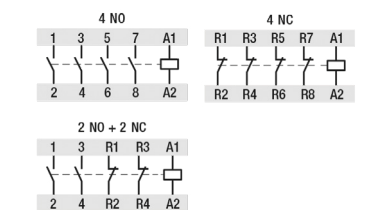


fig. 2. DC load limit curve

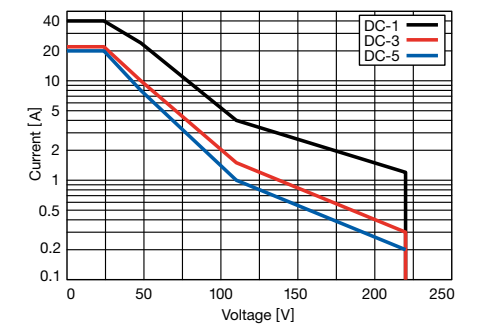
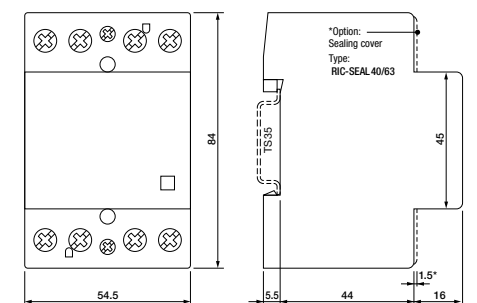


fig. 3. Dimensions (mm)



Standards and approvals

Standards IEC/EN 60947, IEC/EN 61095



Approvals

RIC63

Installation Contactor | 4 pole | 63 A | 13.3 kW

Main circuit

Contact material	AgSnO ₂
Rated voltage	400 V
Rated current AC-1	63A
Minimum contact load	50 mA, 17 V
Inrush current	240 A, 100 ms / 1500 A, 300 μs
Rated load AC-1, 230 V	13.3 kW
Rated load AC-3, 230 V	6 kW
Rated load DC-1, DC-3, DC-5	fig. 2
Mechanical endurance (cycles)	≥ 1 x 10 ⁷
Electrical endurance at rated load AC-1 (cycles)	≥ 1 x 10 ⁵
Electrical endurance at rated load AC-3 (cycles)	≥ 1.5 x 10 ⁵
Electrical endurance at rated load DC-1 (cycles)	≥ 1 x 10 ⁵
Switching frequency at rated load AC-1 (cycles/h)	≤ 600
Switching frequency at rated load AC-3 (cycles/h)	≤ 600
Switching frequency at rated load DC-1 (cycles/h)	≤ 300

Control circuit

Nominal voltage	230 V AC	24 V UC, 230 V UC
Operating voltage range	0.85 ... 1.1 U _N	
Typ. pick-up voltage	≤ 0.85 U _N	
Typ. release voltage	≥ 0.1 U _N	
Pick-up time	15 ... 20 ms	
Release time	35 ... 45 ms	
Power consumption AC / DC	5 VA / 5 W	
Rated frequency	50 / 60 Hz	40 ... 500 Hz

Insulation

Rated insulation voltage	440 V
Rated impulse withstand voltage open contact	6 kV
Pollution degree	3
Overvoltage category	III
Clearance of open contact	3.6 mm

General data

Ambient temperature storage	-30 ... 80 °C
Ambient temperature operation 2 Device / 1 Spacer	-15 ... 55 °C
Ambient temperature operation 3 Device / 1 Spacer	-15 ... 40 °C
Conductor cross section Control / Main Circuit	2.5 mm ² / 16 mm ²
Nominal screw torque Control / Main Circuit	0.6 Nm / 3.5 Nm
Module width	fig. 3
Weight	420 g
Protection degree	IP 20
Housing material	PA 6

Product references

Main circuit	Product reference	230	24
4 NC	RIC63-040/AC...V	✓	
4 NO	RIC63-400/UC...V	✓	✓
4 NC	RIC63-040/UC...V		✓
2 NO + 2 NC	RIC63-220/UC...V	✓	✓

"..." list control circuit voltage to complete product references.
Other voltages on request. Please contact support@comatreleco.com.

Accessories

Auxiliary module	RIC-AUX
Sealing cover	RIC-SEAL40/63
Spacer	RIC-DIST



fig. 1. Wiring diagram

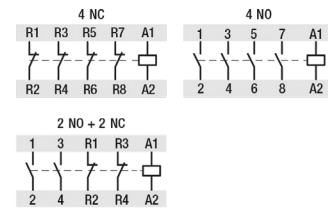


fig. 2. DC load limit curve

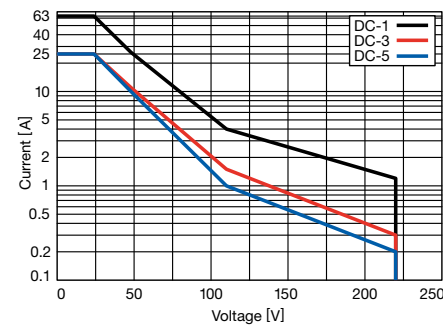
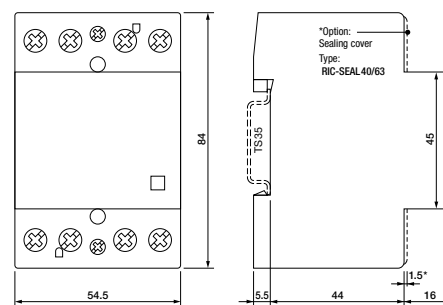


fig. 3. Dimensions (mm)



Standards and approvals

Standards IEC/EN 60947, IEC/EN 61095



RAC20

Installation Contactor – manual lever Auto - 1 - Lock | 2 pole | 20 A | 4 kW

Main circuit

Contact material	AgNi
Rated voltage	400 V
Rated current AC-1	20 A
Minimum contact load	50 mA, 17 V
Inrush current	50 A, 100 ms / 180 A, 300 μs
Rated load AC-1, 230 V	4 kW
Rated load AC-3, 230 V	1.3 kW (NO) / 0.75 kW (NC)
Rated load DC-1, DC-3, DC-5	fig. 2
Mechanical endurance (cycles)	≥ 1 x 10 ⁷
Electrical endurance at rated load AC-1 (cycles)	≥ 2 x 10 ⁵
Electrical endurance at rated load AC-3 (cycles)	≥ 3 x 10 ⁵
Electrical endurance at rated load DC-1 (cycles)	≥ 1 x 10 ⁵
Switching frequency at rated load AC-1 (cycles/h)	≤ 600
Switching frequency at rated load AC-3 (cycles/h)	≤ 600
Switching frequency at rated load DC-1 (cycles/h)	≤ 300

Control circuit

Nominal voltage	24 V UC, 230 V UC
Operating voltage range	0.85 ... 1.1 U _N
Typ. pick-up voltage	≤ 0.85 U _N
Typ. release voltage	≥ 0.1 U _N
Pick-up time	15 ... 45 ms
Release time	20 ... 50 ms
Power consumption AC / DC	2.1 VA / 2.1 W
Rated frequency	40 ... 500Hz

Insulation

Rated insulation voltage	440 V
Rated impulse withstand voltage open contact	4 kV
Pollution degree	3
Overvoltage category	III
Clearance of open contact	3.6 mm

General data

Ambient temperature storage	-30 ... 80 °C
Ambient temperature operation 2 Device / 1 Spacer	-15 ... 55 °C
Ambient temperature operation 3 Device / 1 Spacer	-15 ... 40 °C
Conductor cross section Control / Main Circuit	2.5 mm ² / 6 mm ²
Nominal screw torque Control / Main Circuit	0.6 Nm / 1.2 Nm
Module width	fig. 3
Weight	130 g
Protection degree	IP 20
Housing material	PA 6

Product references

Main circuit	Product reference	24	230
2 NO	RAC20-200/UC...V	✓	✓
2 NC	RAC20-020/UC...V	✓	✓
1 NO + 1 NC	RAC20-110/UC...V	✓	✓

"..." list control circuit voltage to complete product references.
Other voltages on request. Please contact support@comatreleco.com.

Accessories

Sealing cover	RIC-SEAL20
Spacer	RIC-DIST

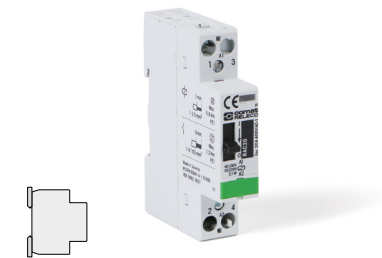


fig. 1. Wiring diagram

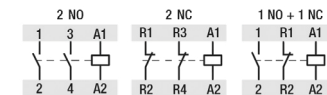


fig. 2. DC load limit curve

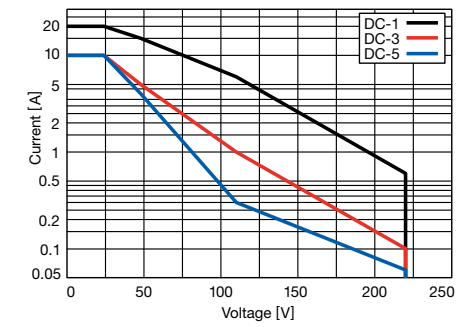
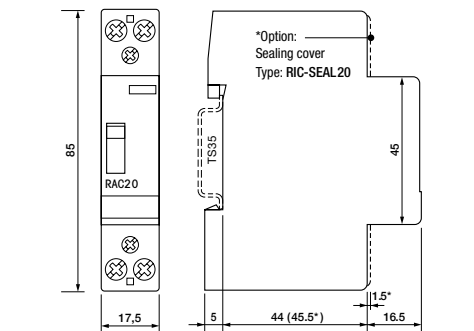


fig. 3. Dimensions (mm)



Standards and approvals

Standards IEC/EN 60947, IEC/EN 61095



RAC25

Installation Contactor – manual lever Auto - 1 - Lock | 2 pole | 25 A | 5.4 kW

Main circuit

Contact material	AgNi
Rated voltage	400 V
Rated current AC-1	25 A
Minimum contact load	50 mA, 17 V
Inrush current	60 A, 100 ms / 280 A, 300 μs
Rated load AC-1, 230 V	5.4 kW
Rated load AC-3, 230 V	1.3 kW
Rated load DC-1, DC-3, DC-5	fig. 2
Mechanical endurance (cycles)	≥ 1 x 10 ⁷
Electrical endurance at rated load AC-1 (cycles)	≥ 2 x 10 ⁵
Electrical endurance at rated load AC-3 (cycles)	≥ 5 x 10 ⁵
Electrical endurance at rated load DC-1 (cycles)	≥ 1 x 10 ⁵
Switching frequency at rated load AC-1 (cycles/h)	≤ 600
Switching frequency at rated load AC-3 (cycles/h)	≤ 600
Switching frequency at rated load DC-1 (cycles/h)	≤ 300

Control circuit

Nominal voltage	24 V UC, 230 V UC
Operating voltage range	0.85 ... 1.1 U _N
Typ. pick-up voltage	≤ 0.85 U _N
Typ. release voltage	≥ 0.1 U _N
Pick-up time	15 ... 45 ms
Release time	20 ... 70 ms
Power consumption AC / DC	2.6 VA / 2.6 W
Rated frequency	40 ... 500Hz

Insulation

Rated insulation voltage	440 V
Rated impulse withstand voltage open contact	4 kV
Pollution degree	3
Overvoltage category	III
Clearance of open contact	3.6 mm

General data

Ambient temperature storage	-30 ... 80 °C
Ambient temperature operation 2 Device / 1 Spacer	-15 ... 55 °C
Ambient temperature operation 3 Device / 1 Spacer	-15 ... 40 °C
Conductor cross section Control / Main Circuit	2.5 mm ² / 6 mm ²
Nominal screw torque Control / Main Circuit	0.6 Nm / 1.2 Nm
Module width	fig. 3
Weight	250 g
Protection degree	IP 20
Housing material	PA 6

Product references

Main circuit	Product reference	24	230
4 NO	RAC25-400/UC...V	✓	✓
2 NO + 2 NC	RAC25-220/UC...V	✓	✓

"..." list control circuit voltage to complete product references.
Other voltages on request. Please contact support@comatreleco.com.

Accessories

Auxiliary module	RIC-AUX
Sealing cover	RIC-SEAL25
Spacer	RIC-DIST



fig. 1. Wiring diagram

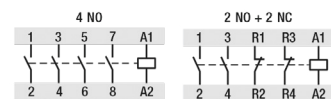


fig. 2. DC load limit curve

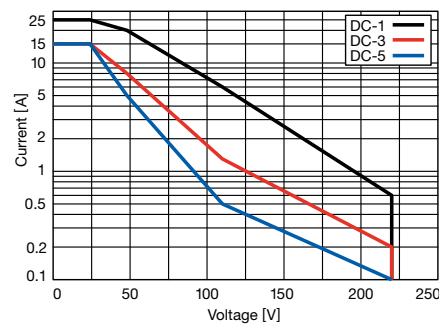
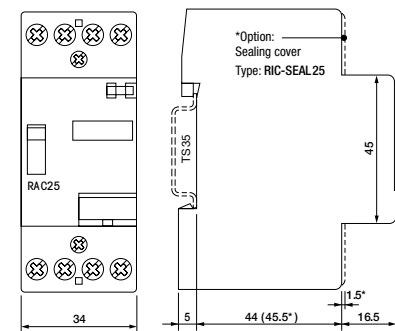


fig. 3. Dimensions (mm)



Standards and approvals

Standards IEC/EN 60947, IEC/EN 61095



Approvals

RAC40

Installation Contactor – manual lever Auto - 1 - Lock | 4 pole | 40 A | 8.7 kW

Main circuit

Contact material	AgSnO ₂
Rated voltage	400 V
Rated current AC-1	40 A
Minimum contact load	50 mA, 17 V
Inrush current	170 A, 100 ms / 970 A, 300 μs
Rated load AC-1, 230 V	8.7 kW
Rated load AC-3, 230 V	3.7 kW
Rated load DC-1, DC-3, DC-5	fig. 2
Mechanical endurance (cycles)	≥ 1 x 10 ⁷
Electrical endurance at rated load AC-1 (cycles)	≥ 1 x 10 ⁵
Electrical endurance at rated load AC-3 (cycles)	≥ 1.5 x 10 ⁵
Electrical endurance at rated load DC-1 (cycles)	≥ 1 x 10 ⁵
Switching frequency at rated load AC-1 (cycles/h)	≤ 600
Switching frequency at rated load AC-3 (cycles/h)	≤ 600
Switching frequency at rated load DC-1 (cycles/h)	≤ 300

Control circuit

Nominal voltage	230 V AC
Operating voltage range	0.85 ... 1.1 U _N
Typ. pick-up voltage	≤ 0.85 U _N
Typ. release voltage	≥ 0.1 U _N
Pick-up time	15 ... 20 ms
Release time	35 ... 45 ms
Power consumption AC / DC	5 VA / 5 W
Rated frequency	50 / 60 Hz

Insulation

Rated insulation voltage	440 V
Rated impulse withstand voltage open contact	6 kV
Pollution degree	3
Overvoltage category	III
Clearance of open contact	3.6 mm

General data

Ambient temperature storage	-30 ... 80 °C
Ambient temperature operation 2 Device / 1 Spacer	-15 ... 55 °C
Ambient temperature operation 3 Device / 1 Spacer	-15 ... 40 °C
Conductor cross section Control / Main Circuit	2.5 mm ² / 16 mm ²
Nominal screw torque Control / Main Circuit	0.6 Nm / 3.5 Nm
Module width	fig. 3
Weight	420 g
Protection degree	IP 20
Housing material	PA 6

Product references

Main circuit	Product reference	230
4 NO	RAC40-400/AC...V	✓
3 NO + 1 NC	RAC40-310/AC...V	✓

"..." list control circuit voltage to complete product references.
Other voltages on request. Please contact support@comatreleco.com.

Accessories

Auxiliary module	RIC-AUX
Sealing cover	RIC-SEAL40/63
Spacer	RIC-DIST



fig. 1. Wiring diagram

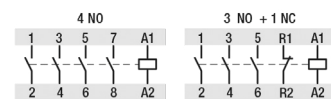


fig. 2. DC load limit curve

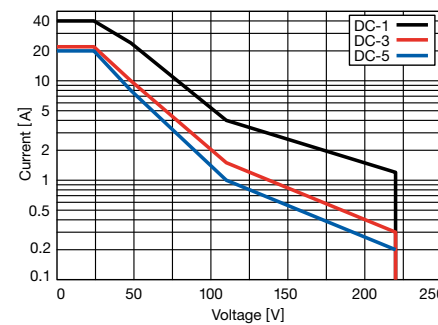
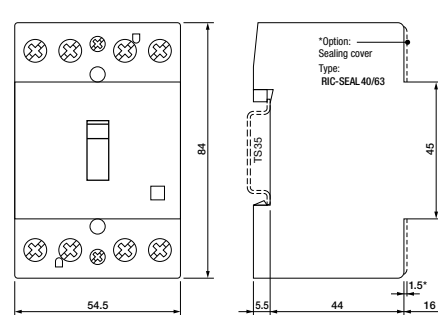


fig. 3. Dimensions (mm)



Standards and approvals

Standards IEC/EN 60947, IEC/EN 61095



Approvals

RAC63

Installation Contactor – manual lever Auto - 1 - Lock | 4 pole | 63 A | 13.3 kW

Main circuit

Contact material	AgSnO ₂
Rated voltage	400 V
Rated current AC-1	63 A
Minimum contact load	50 mA, 17 V
Inrush current	240 A, 100 ms / 1500 A, 300 μs
Rated load AC-1, 230 V	13.3 kW
Rated load AC-3, 230 V	6 kW
Rated load DC-1, DC-3, DC-5	fig. 2
Mechanical endurance (cycles)	≥ 1 x 10 ⁷
Electrical endurance at rated load AC-1 (cycles)	≥ 1 x 10 ⁵
Electrical endurance at rated load AC-3 (cycles)	≥ 1.5 x 10 ⁵
Electrical endurance at rated load DC-1 (cycles)	≥ 1 x 10 ⁵
Switching frequency at rated load AC-1 (cycles/h)	≤ 600
Switching frequency at rated load AC-3 (cycles/h)	≤ 600
Switching frequency at rated load DC-1 (cycles/h)	≤ 300

Control circuit

Nominal voltage	230 V AC
Operating voltage range	0.85 ... 1.1 U _N
Typ. pick-up voltage	≤ 0.85 U _N
Typ. release voltage	≥ 0.1 U _N
Pick-up time	15 ... 20 ms
Release time	35 ... 45 ms
Power consumption AC / DC	5 VA / 5 W
Rated frequency	50 / 60 Hz

Insulation

Rated insulation voltage	440 V
Rated impulse withstand voltage open contact	6 kV
Pollution degree	3
Overvoltage category	III
Clearance of open contact	3.6 mm

General data

Ambient temperature storage	-30 ... 80 °C
Ambient temperature operation 2 Device / 1 Spacer	-15 ... 55 °C
Ambient temperature operation 3 Device / 1 Spacer	-15 ... 40 °C
Conductor cross section Control / Main Circuit	2.5 mm ² / 16 mm ²
Nominal screw torque Control / Main Circuit	0.6 Nm / 3.5 Nm
Module width	fig. 3
Weight	420 g
Protection degree	IP 20
Housing material	PA 6

Product references

Main circuit	Product reference	230
4 NO	RAC63-400/AC...V	✓
3 NO + 1 NC	RAC63-310/AC...V	✓

"..." list control circuit voltage to complete product references.
Other voltages on request. Please contact support@comatreleco.com.

Accessories

Auxiliary module	RIC-AUX
Sealing cover	RIC-SEAL40/63
Spacer	RIC-DIST

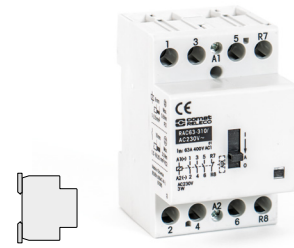


fig. 1. Wiring diagram

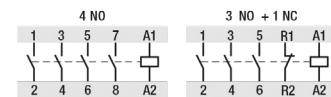


fig. 2. DC load limit curve

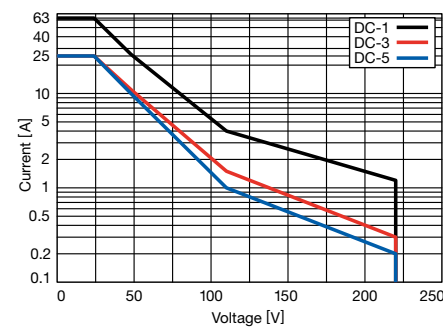
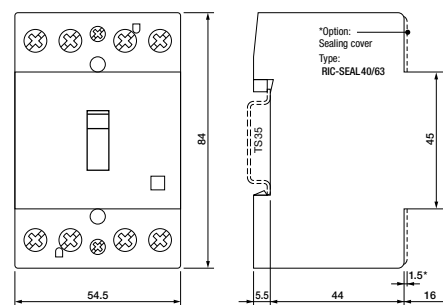
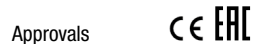


fig. 3. Dimensions (mm)



Standards and approvals

Standards IEC/EN 60947, IEC/EN 61095



Approvals

RBC20

Installation Contactor – Step switch - manual lever 0 - 1 - Lock | 2 or 4 pole | 20 A | 4.4 kW

Main circuit

Contact material	AgNi
Rated voltage	400 V
Rated current AC-1	20 A
Minimum contact load	100 mA, 10 V
Inrush current	50 A, 100 ms / 180 A, 300 μs
Rated load AC-1, 230 V	4.4 kW
Rated load AC-3, 230 V	0.55 kW
Rated load DC-1, DC-3, DC-5	fig. 2
Mechanical endurance (cycles)	≥ 1 x 10 ⁶
Electrical endurance at rated load AC-1 (cycles)	≥ 1 x 10 ⁵
Electrical endurance at rated load AC-3 (cycles)	≥ 1 x 10 ⁵
Electrical endurance at rated load DC-1 (cycles)	≥ 1 x 10 ⁵
Switching frequency at rated load AC-1 (cycles/h)	≤ 600
Switching frequency at rated load AC-3 (cycles/h)	≤ 600
Switching frequency at rated load DC-1 (cycles/h)	≤ 300

Control circuit

Nominal voltage	24 V AC, 230 V AC
Operating voltage range	0.9 ... 1.1 U _N
Typ. pick-up voltage	≤ 0.75 U _N
Typ. release voltage	≥ 0.1 U _N
Minimal impulse duration at rated voltage U _N	50 ms
Minimal impulse duration at 0.9 U _N	100 ms
Minimal pause between two impulses	150 ms
Maximal number of impulses	≤ 15 / min
Maximal impulse duration	≤ 60 / min
Pick-up time	5 ... 35 ms
Release time	5 ... 35 ms
Power consumption AC / DC	9 VA / - W
Rated frequency	50 / 60 Hz

Insulation

Rated insulation voltage	440 V
Rated impulse withstand voltage open contact	4 kV
Pollution degree	3
Overvoltage category	III
Clearance of open contact	> 3 mm

General data

Ambient temperature storage	-30 ... 80 °C
Ambient temperature operation 2 Device / 1 Spacer	55 ° ... 70 °C
Ambient temperature operation 3 Device / 1 Spacer	40 ° ... 55 °C
Conductor cross section Control / Main Circuit	4 mm ² / 10 mm ²
Nominal screw torque Control / Main Circuit	0.6 Nm / 1.2 Nm
Module width	fig. 3
Weight	132 g (2 pole) / 250 g (4 pole)
Protection degree	IP 20
Housing material	PA 6

Product references

Main circuit	Product reference	24	230
2 NO	RBC20-200/AC...V	✓	✓
1 NO + 1 NC	RBC20-110/AC...V	✓	
4 NO	RBC20-400/AC...V	✓	✓

"..." list control circuit voltage to complete product references.
Other voltages on request. Please contact support@comatreleco.com.

Accessories

Auxiliary module	RBC-AUX
Auxiliary module for centralised control	RBC-AUX-CM
Auxiliary module for group control	RBC-AUX-GM
Spacer	RIC-DIST



fig. 1. Wiring diagram

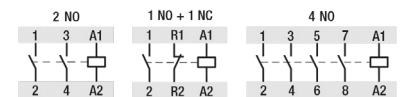


fig. 2. DC load limit curve

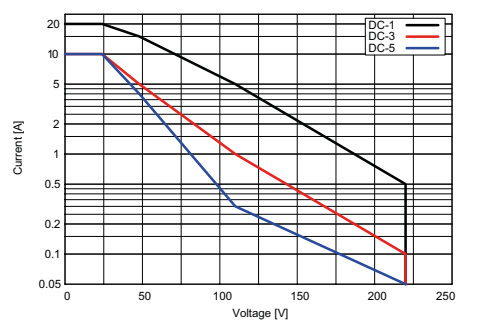
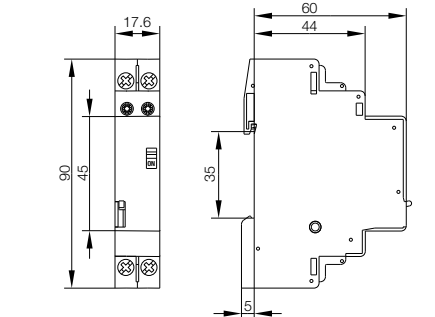
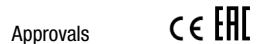


fig. 3. Dimensions (mm)



Standards and approvals

Standards IEC/EN 60947, IEC/EN 61095



Approvals

RBC32

Installation Contactor – Step switch - manual lever 0 - 1 - Lock | 4 pole | 32 A | 7 kW

Main circuit

Contact material	AgNi
Rated voltage	440 V
Rated current AC-1	32 A
Minimum contact load	100 mA, 10 V
Inrush current	50 A, 100 ms / 180 A, 300 μs
Rated load AC-1, 230 V	7 kW
Rated load AC-3, 230 V	1.1 kW
Rated load DC-1, DC-3, DC-5	fig. 2
Mechanical endurance (cycles)	≥ 1 x 10 ⁶
Electrical endurance at rated load AC-1 (cycles)	≥ 1 x 10 ⁵
Electrical endurance at rated load AC-3 (cycles)	≥ 1 x 10 ⁵
Electrical endurance at rated load DC-1 (cycles)	≥ 1 x 10 ⁵
Switching frequency at rated load AC-1 (cycles/h)	≤ 450
Switching frequency at rated load AC-3 (cycles/h)	≤ 450
Switching frequency at rated load DC-1 (cycles/h)	≤ 300

Control circuit

Nominal voltage	230 V AC
Operating voltage range	0.9 ... 1.1 U _N
Typ. pick-up voltage	≤ 0.75 U _N
Typ. release voltage	≥ 0.1 U _N
Minimal impulse duration at rated voltage U _N	50 ms
Minimal impulse duration at 0.9 U _N	100 ms
Minimal pause between two impulses	150 ms
Maximal number of impulses	≤ 8 / min
Maximal impulse duration	≤ 60 / min
Pick-up time	5 ... 35 ms
Release time	5 ... 35 ms
Power consumption AC / DC	9 VA / - W
Rated frequency	50 / 60 Hz

Insulation

Rated insulation voltage	440 V
Rated impulse withstand voltage open contact	4 kV
Pollution degree	3
Overtoltage category	III
Clearance of open contact	> 3 mm

General data

Ambient temperature storage	-30 ... 80 °C
Ambient temperature operation 2 Device / 1 Spacer	55 ° ... 70 °C
Ambient temperature operation 3 Device / 1 Spacer	40 ° ... 55 °C
Conductor cross section Control / Main Circuit	4 mm ² / 10 mm ²
Nominal screw torque Control / Main Circuit	0.6 Nm / 1.2 Nm
Module width	fig. 3
Weight	192 g
Protection degree	IP 20
Housing material	PA 6

Product references

Main circuit	Product reference	230
4 NO	RBC32-400/AC...V	✓
2 NO + 2 NC	RBC32-220/AC...V	✓

"..." list control circuit voltage to complete product references.

Other voltages on request. Please contact support@comatreleco.com.

Accessories

Auxiliary module	RBC-AUX
Auxiliary module for centralised control	RBC-AUX-CM
Auxiliary module for group control	RBC-AUX-GM
Spacer	RIC-DIST



fig. 1. Wiring diagram

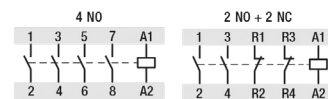


fig. 2. DC load limit curve

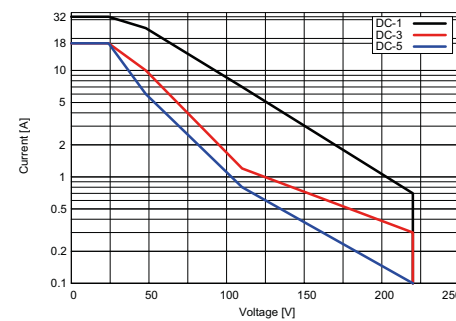
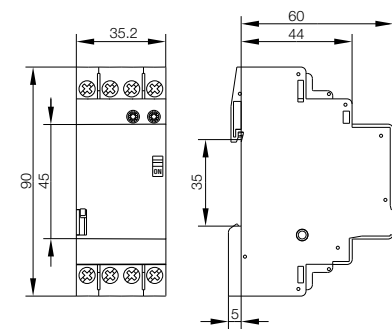


fig. 3. Dimensions (mm)



Standards and approvals

Standards IEC/EN 60947, IEC/EN 61095



RIC-AUX

Auxiliary module for RIC | RAC Installation contactors | 2 pole | 6 A

Main circuit

Contact material	AgNi
Rated voltage	230 V / 400 V
Rated current AC-1	6 A / 4 A
Minimum contact load	5 mA, 12 V

Insulation

Rated insulation voltage	500 V
Rated impulse withstand voltage	4 kV
Pollution degree	3
Overtoltage category	III
Clearance of open contact	3.6 mm

General data

Ambient temperature storage	-30 ... 80 °C
Ambient temperature operation	-25 ... 55 °C
Conductor cross section main circuit	2.5 mm ²
Nominal screw torque Control / Main Circuit	- Nm / 0.8 Nm
Module width	fig. 2
Weight	30 g
Protection degree	IP 20
Housing material	PA 6

Product references

Main circuit	Product reference
2 NO	RIC-AUX20
2 NC	RIC-AUX02
1 NO + 1 NC	RIC-AUX11

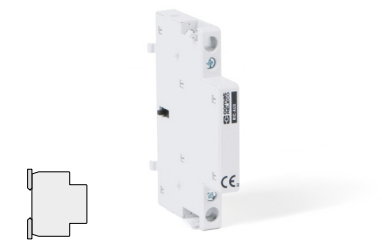


fig. 1. Wiring diagram

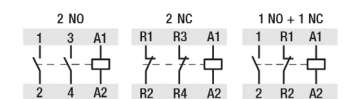
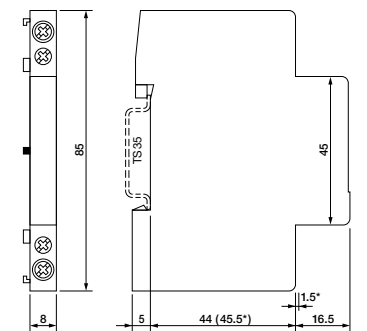


fig. 2. Dimensions (mm)



Standards and approvals

Standards IEC/EN 60947



RBC-AUX

Auxiliary module for step switch Installation contactors | 2 pole | 6 A

Main circuit

Contact material	AgNi
Rated voltage	250 V
Rated current AC-1	6 A
Minimum contact load	5 mA, 12 V

Insulation

Rated insulation voltage	440 V
Rated impulse withstand voltage open contact	4 kV
Rated impulse withstand voltage	4 kV
Pollution degree	3
Overvoltage category	III
Clearance of open contact	> 3 mm

General data

Ambient temperature storage	-30 ... 80 °C
Ambient temperature operation open contact	-25 ... 70 °C
Conductor cross section main circuit	2.5 mm ²
Nominal screw torque Control / Main Circuit	- Nm / 0.8 Nm
Module width	fig. 2
Weight	30 g
Protection degree	IP 20
Housing material	PA 6

Product references

Main circuit	Product reference
2 NO	RBC-AUX20
1 NO + 1 NC	RBC-AUX11

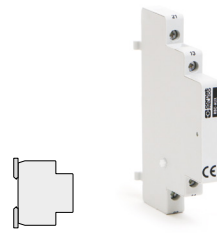


fig. 1. Wiring diagram

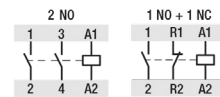
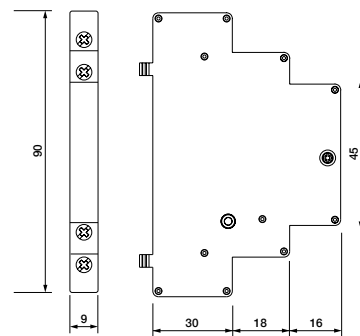


fig. 2. Dimensions (mm)



Standards and approvals

Standards IEC/EN 60947

Approvals

RBC-AUX-CM

Auxiliary module for step switch Installation contactors - centralized control ON - OFF

Main circuit

Rated voltage	250 V
---------------	-------

Insulation

Rated insulation voltage	440 V
Pollution degree	3

General data

Ambient temperature storage	-30 ... 80 °C
Ambient temperature operation open contact	-25 ... 70 °C
Conductor cross section main circuit	2.5 mm ²
Nominal screw torque Control / Main Circuit	- Nm / 0.8 Nm
Module width	fig. 2
Weight	30 g
Protection degree	IP 20
Housing material	PA 6

Product references

Description	Product reference
Centralized control ON – OFF	RBC-AUX-CM

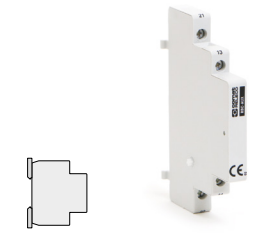


fig. 1. Wiring diagram

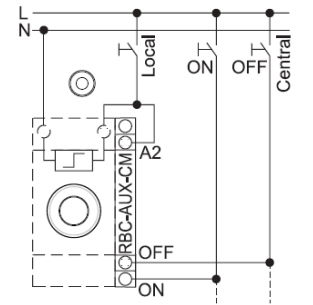
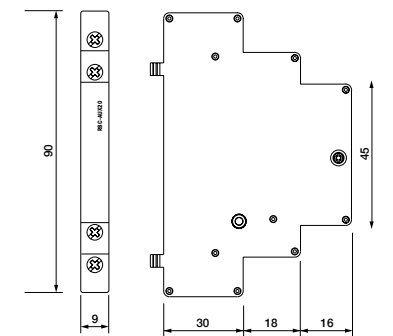


fig. 2. Dimensions (mm)



Standards and approvals

Standards IEC/EN 60947

Approvals

RBC-AUX-GM

Auxiliary module for step switch Installation contactors - group control ON - OFF

Main circuit	
Rated voltage	250 V
Insulation	
Rated insulation voltage	440 V
Pollution degree	3
General data	
Ambient temperature storage	-30 ... 80 °C
Ambient temperature operation open contact	-25 ... 70 °C
Conductor cross section main circuit	2.5 mm ²
Nominal screw torque Control / Main Circuit	- Nm / 0.8 Nm
Module width	fig. 2
Weight	30 g
Protection degree	IP 20
Housing material	PA 6

Product references	
Description	Product reference
Group control ON – OFF	RBC-AUX-GM



fig. 1. Wiring diagram

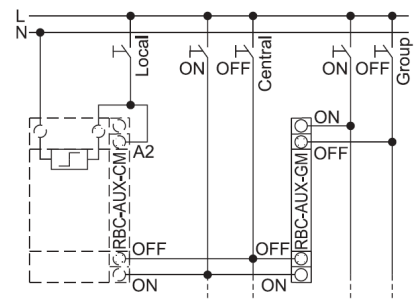
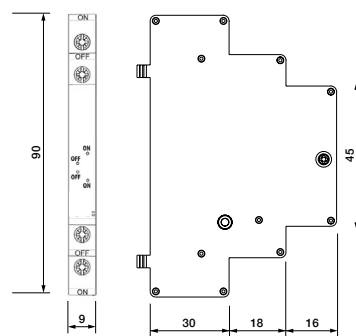


fig. 2. Dimensions (mm)



Standards and approvals

Standards IEC/EN 60947

Approvals

RIC-DIST

Auxiliary spacer module for RIC / RAC installation contactors

General data	
Ambient temperature storage	-30 ... 80 °C
Module width	fig. 1
Weight	13 g
Material	PA 6

Product references	
Description	Product reference
Spacer	RIC-DIST

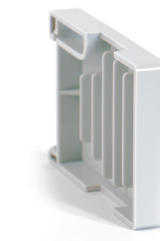
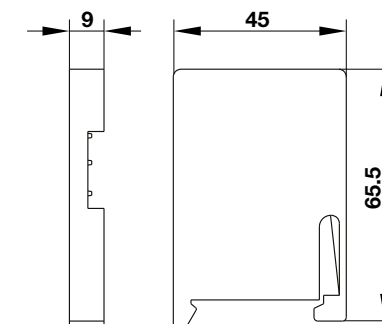


fig. 1. Dimensions (mm)



RIC-SEAL**Auxiliary sealing cover for RIC / RAC installation contactors****General data**

Ambient temperature storage	-30 ... 80 °C
Weight RIC-SEAL20, RIC-SEAL25, RIC-SEAL 40/63	1 g, 2 g, 3 g
Material	PA 6

Product references

Description	Product reference
Sealing cover	RIC-SEAL20
Sealing cover	RIC-SEAL25
Sealing cover	RIC-SEAL40/63



1.8 Industrial Contactors

Application	Type	Page
RMC Series		
Industrial Contactor 4 pole 8.5 A 4 kW	RMC08	114
Industrial Contactor 4 pole 11.3 A 5.5 kW	RMC11	115
RSC Series		
Industrial Contactor 3 or 4 pole 9 A 4 kW	RSC09	116
Industrial Contactor 3 or 4 pole 12 A 5.5 kW	RSC12	117
Industrial Contactor 3 or 4 pole 16 A 7.5 kW	RSC16	118
Industrial Contactor 3 pole 22 A 11 kW	RSC22	119
Industrial Contactor 3 pole 30 A 15 kW	RSC30	120
Industrial Contactor 3 pole 38 A 18.5 kW	RSC38	121
Industrial Contactor 5 pole 43 A 22 kW	RSC43	122
Industrial Contactor 5 pole 63 A 30 kW	RSC63	123
Bimetallic thermal relay 5 pole 01 ... 10 A	RSC-MP	124
Accessories		
Auxiliary module 2 or 4 pole 6 A	RMC-AUX	125
Auxiliary module 2 or 4 pole 6 A	RSC-AUX	126
Supressor	RMC-RC	127
Supressor	RSC-RC	128
Supressor	RMC-DI	129
Mechanical interlock	RSC-MBL	130

RMC08

Industrial Contactor | 4 pole | 8.5 A | 4 kW

Main circuit

Contact material	AgNi
Rated voltage	690 V
Rated current AC-1	20 A
Rated current AC-3	8.5 A, 400 V
Rated current DC-13	0.25 A, 110 VDC
Minimum contact load	50 mA, 17 V
Rated load AC-1, 400 V	13 kW
Rated load AC-3, 400 V	4 kW
Mechanical endurance (cycles)	≥ 1 x 10 ⁷
Electrical endurance at rated load AC-1 (cycles)	≥ 2 x 10 ⁵
Electrical endurance at rated load AC-3 (cycles)	fig. 2
Switching frequency at rated load AC-1 (cycles/h)	≤ 600
Switching frequency at rated load AC-3 (cycles/h)	≤ 600
Switching frequency at rated load DC-3	≤ 300

Control circuit

Nominal voltage	24 V AC, 230 V AC	24 V DC
Operating voltage range	0.85 ... 1.1 U _N	
Typ. pick-up voltage	≤ 0.85 U _N	
Typ. release voltage	≥ 0.2 U _N AC	≥ 0.1 U _N DC
Pick-up time	10 ... 15 ms	
Release time	6 ... 15 ms	
Power consumption AC / DC	8.1 VA / 4 W	
Rated frequency	50 / 60 Hz	

Insulation

Rated insulation voltage	690 V
Rated impulse withstand voltage	6 kV
Pollution degree	3
Overvoltage category	III
Clearance of open contact	3.6 mm

General data

Ambient temperature storage	-30 ... 80 °C
Ambient temperature operation open contact	-20 ... 60 °C
Ambient temperature operation close contact	-20 ... 45 °C
Conductor cross section Control / Main Circuit	2.5 mm ² / 2.5 mm ²
Nominal screw torque Control / Main Circuit	1.2 Nm / 1.2 Nm
Module width	fig. 3
Weight AC / DC Device	160 g / 215 g
Protection degree	IP 20
Housing material	PA 66

Product references

Main circuit	Product reference	24	230
3 NO + 1 NO	RMC08-310/AC...V	✓	✓
3 NO + 1 NC	RMC08-301/AC...V	✓	✓
3 NO + 1 NO	RMC08-310/DC...V	✓	
3 NO + 1 NC	RMC08-301/DC...V	✓	

"..." list control circuit voltage to complete product references
Other voltages on request. Please contact support@comatreleco.com

Accessories

Auxiliary module	RMC-AUX
RC - Suppressor	RMC-RC
DI - Suppressor	RMC-DI



fig. 1. Wiring diagram

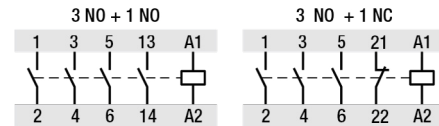


fig. 2. Electrical endurance

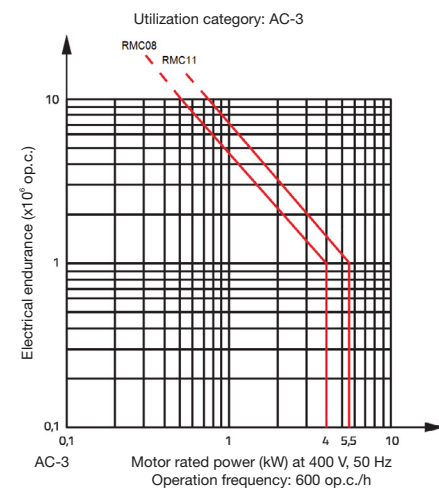
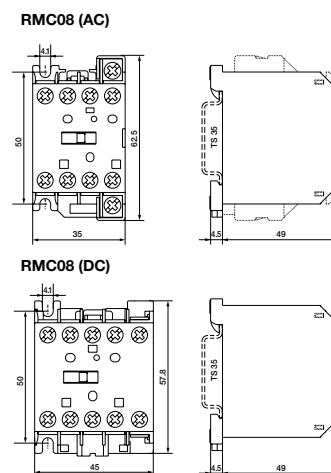


fig. 3. Dimensions (mm)



Standards and approvals

Standards IEC/EN 60947



RMC11

Industrial Contactor | 4 pole | 11.3 A | 5.5 kW

Main circuit

Contact material	AgNi
Rated voltage	690 V
Rated current AC-1	20 A
Rated current AC-3	11.3 A, 400 V
Rated current DC-13	0.25 A, 110 VDC
Minimum contact load	50 mA, 17 V
Rated load AC-1, 400 V	13 kW
Rated load AC-3, 400 V	5.5 kW
Mechanical endurance (cycles)	≥ 1 x 10 ⁷
Electrical endurance at rated load AC-1 (cycles)	≥ 2 x 10 ⁵
Electrical endurance at rated load AC-3 (cycles)	fig. 2
Switching frequency at rated load AC-1 (cycles/h)	≤ 600
Switching frequency at rated load AC-3 (cycles/h)	≤ 600
Switching frequency at rated load DC-3	≤ 300

Control circuit

Nominal voltage	24 V AC, 230 V AC	24 V DC
Operating voltage range	0.85 ... 1.1 U _N	
Typ. pick-up voltage	≤ 0.85 U _N	
Typ. release voltage	≥ 0.2 U _N AC	≥ 0.1 U _N DC
Pick-up time	10 ... 15 ms	
Release time	6 ... 15 ms	
Power consumption AC / DC	8.1 VA / 4 W	
Rated frequency	50 / 60 Hz	

Insulation

Rated insulation voltage	690 V
Rated impulse withstand voltage	6 kV
Pollution degree	3
Overvoltage category	III
Clearance of open contact	3.6 mm

General data

Ambient temperature storage	-30 ... 80 °C
Ambient temperature operation open contact	-20 ... 60 °C
Ambient temperature operation close contact	-20 ... 45 °C
Conductor cross section Control / Main Circuit	2.5 mm ² / 2.5 mm ²
Nominal screw torque Control / Main Circuit	1.2 Nm / 1.2 Nm
Module width	fig. 3
Weight AC / DC Device	170 g / 215 g
Protection degree	IP 20
Housing material	PA 66

Product references

Main circuit	Product reference	24	230
3 NO + 1 NO	RMC11-310/AC...V	✓	✓
3 NO + 1 NC	RMC11-301/AC...V	✓	✓
3 NO + 1 NO	RMC11-310/DC...V	✓	
3 NO + 1 NC	RMC11-301/DC...V	✓	

"..." list control circuit voltage to complete product references
Other voltages on request. Please contact support@comatreleco.com

Accessories

Auxiliary module	RMC-AUX
RC - Suppressor	RMC-RC
DI - Suppressor	RMC-DI

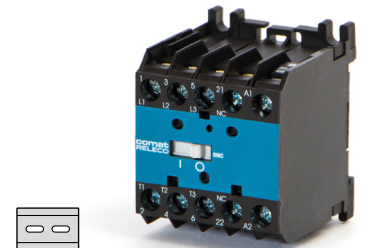


fig. 1. Wiring diagram

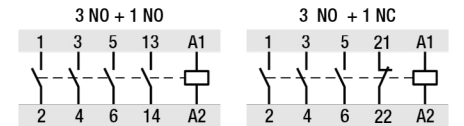


fig. 2. Electrical endurance

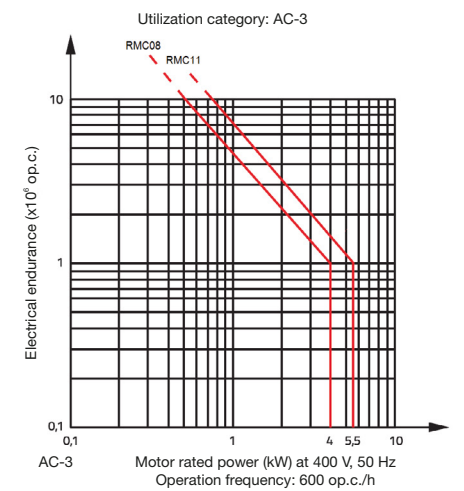
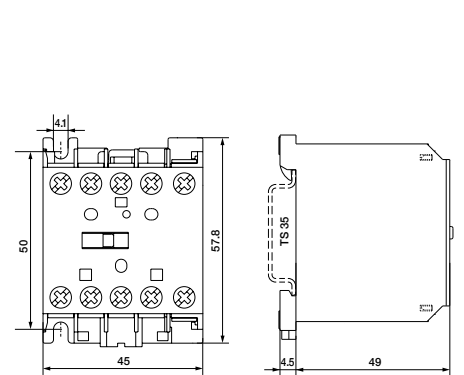


fig. 3. Dimensions (mm)



Standards and approvals

Standards IEC/EN 60947



RSC09

Industrial Contactor | 3 or 4 pole | 9 A | 4 kW

Main circuit

Contact material	AgNi
Rated voltage	690 V
Rated current AC-1	25 A
Rated current AC-3	9 A, 400 V
Rated current DC-3	0.75 A, 220 V DC
Minimum contact load	50 mA, 17 V
Overload current	72 A (10 s) / 220 A (0.001 s)
Rated load AC-1, 400 V	16 kW
Rated load AC-3, 400 V	4 kW
Mechanical endurance (cycles)	$\geq 1 \times 10^7$
Electrical endurance at rated load AC-1 (cycles)	$\geq 2 \times 10^5$
Electrical endurance at rated load AC-3 (cycles)	fig. 2
Switching frequency at rated load AC-1 (cycles/h)	≤ 600
Switching frequency at rated load AC-3 (cycles/h)	≤ 600
Switching frequency at rated load DC-3	≤ 300

Control circuit

Nominal voltage	24 V AC, 230 V AC	24 V DC
Operating voltage range	0.85 ... 1.1 U _N	
Typ. pick-up voltage	$\leq 0.85 U_N$	
Typ. release voltage	$\geq 0.2 U_N$ AC	$\geq 0.1 U_N$ DC
Pick-up time	10 ... 25 ms	
Release time	5 ... 15 ms	
Power consumption AC / DC	8.0 VA / 2.5 W	
Rated frequency	50 / 60 Hz	

Insulation

Rated insulation voltage	690 V
Rated impulse withstand voltage	6 kV
Pollution degree	3
Overvoltage category	III
Clearance of open contact	3.6 mm

General data

Ambient temperature storage	-30 ... 80 °C
Ambient temperature operation open contact	-25 ... 55 °C
Ambient temperature operation close contact	-25 ... 45 °C
Conductor cross section Control / Main Circuit	4 mm ² / 6 mm ²
Nominal screw torque Control / Main Circuit	1.4 Nm / 1.4 Nm
Module width	fig. 3
Weight	300 g
Protection degree	IP 20
Housing material	PA 66

Product references

Main circuit	Product reference	24	230
3 NO + 1 NO	RSC09-310/AC...V	✓	✓
3 NO + 1 NC	RSC09-301/AC...V	✓	✓
3 NO	RSC09-300/DC...V	✓	

"..." list control circuit voltage to complete product references
Other voltages on request. Please contact support@comatreleco.com

Accessories

Auxiliary module	RSC-AUX
Bimetallic thermal relay	RSC-MP
RC - Suppressor	RSC-RC
DI - Suppressor	RMC-DI
MBL - Mechanical locking	RSC-MBL1



fig. 1. Wiring diagram

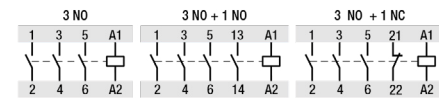


fig. 2. Electrical endurance

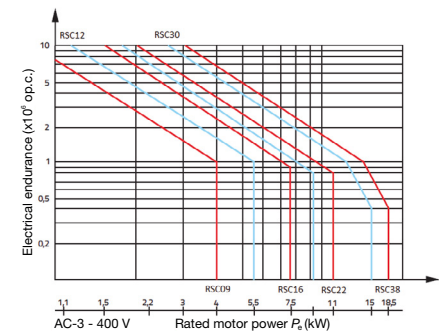
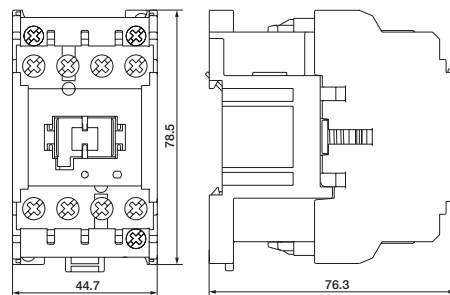


fig. 3. Dimensions (mm)



Standards and approvals

Standards	IEC/EN 60947
Approvals	CE EAC UL US

RSC12

Industrial Contactor | 3 or 4 pole | 12 A | 5.5 kW

Main circuit

Contact material	AgNi
Rated voltage	690 V
Rated current AC-1	25 A
Rated current AC-3	12 A, 400 V
Rated current DC-3	0.75 A, 220 V DC
Minimum contact load	50 mA, 17 V
Overload current	96 A (10 s) / 330 A (0.001 s)
Rated load AC-1, 400 V	16 kW
Rated load AC-3, 400 V	5.5 kW
Mechanical endurance (cycles)	$\geq 1 \times 10^7$
Electrical endurance at rated load AC-1 (cycles)	$\geq 2 \times 10^5$
Electrical endurance at rated load AC-3 (cycles)	fig. 2
Switching frequency at rated load AC-1 (cycles/h)	≤ 600
Switching frequency at rated load AC-3 (cycles/h)	≤ 600
Switching frequency at rated load DC-3	≤ 300

Control circuit

Nominal voltage	24 V AC, 230 V AC	24 V DC
Operating voltage range	0.85 ... 1.1 U _N	
Typ. pick-up voltage	$\leq 0.85 U_N$	
Typ. release voltage	$\geq 0.2 U_N$ AC	$\geq 0.1 U_N$ DC
Pick-up time	10 ... 25 ms	
Release time	5 ... 15 ms	
Power consumption AC / DC	8.0 VA / 2.5 W	
Rated frequency	50 / 60 Hz	

Insulation

Rated insulation voltage	690 V
Rated impulse withstand voltage	6 kV
Pollution degree	3
Overvoltage category	III
Clearance of open contact	3.6 mm

General data

Ambient temperature storage	-30 ... 80 °C
Ambient temperature operation open contact	-25 ... 55 °C
Ambient temperature operation close contact	-25 ... 45 °C
Conductor cross section Control / Main Circuit	4 mm ² / 6 mm ²
Nominal screw torque Control / Main Circuit	1.4 Nm / 1.4 Nm
Module width	fig. 3
Weight	300 g
Protection degree	IP 20
Housing material	PA 66

Product references

Main circuit	Product reference	24	230
3 NO + 1 NO	RSC12-310/AC...V	✓	✓
3 NO + 1 NC	RSC12-301/AC...V	✓	✓
3 NO	RSC12-300/DC...V	✓	

"..." list control circuit voltage to complete product references
Other voltages on request. Please contact support@comatreleco.com

Accessories

Auxiliary module	RSC-AUX
Bimetallic thermal relay	RSC-MP
RC - Suppressor	RSC-RC
DI - Suppressor	RMC-DI
MBL - Mechanical locking	RSC-MBL1



fig. 1. Wiring diagram

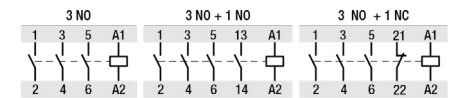


fig. 2. Electrical endurance

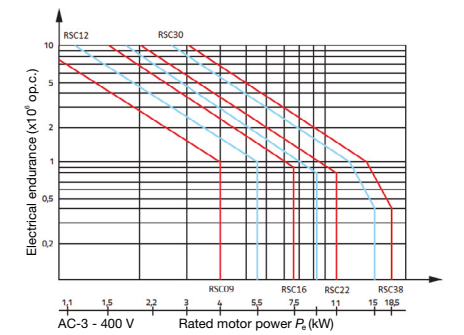
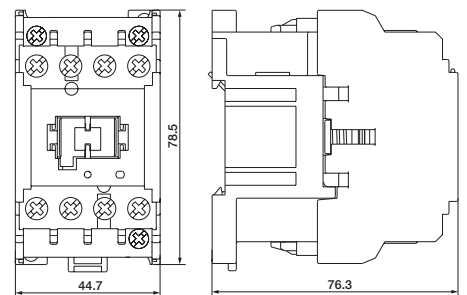


fig. 3. Dimensions (mm)



Standards and approvals

Standards	IEC/EN 60947
Approvals	CE EAC UL US

RSC16

Industrial Contactor | 3 or 4 pole | 16 A | 7.5 kW

Main circuit

Contact material	AgNi
Rated voltage	690 V
Rated current AC-1	25 A
Rated current AC-3	16 A, 400 V
Rated current DC-3	0.75 A, 220 V DC
Minimum contact load	50 mA, 17 V
Overload current	128 A (10 s) / 450 A (0.001 s)
Rated load AC-1, 400 V	16 kW
Rated load AC-3, 400 V	7.5 kW
Mechanical endurance (cycles)	≥ 1 x 10 ⁷
Electrical endurance at rated load AC-1 (cycles)	≥ 2 x 10 ⁵
Electrical endurance at rated load AC-3 (cycles)	fig. 2
Switching frequency at rated load AC-1 (cycles/h)	≤ 600
Switching frequency at rated load AC-3 (cycles/h)	≤ 600
Switching frequency at rated load DC-3	≤ 300

Control circuit

Nominal voltage	24 V AC, 230 V AC	24 V DC
Operating voltage range	0.85 ... 1.1 U _N	
Typ. pick-up voltage	≤ 0.85 U _N	
Typ. release voltage	≥ 0.2 U _N AC	≥ 0.1 U _N DC
Pick-up time	10 ... 25 ms	
Release time	5 ... 15 ms	
Power consumption AC / DC	8.0 VA / 2.5 W	
Rated frequency	50 / 60 Hz	

Insulation

Rated insulation voltage	690 V
Rated impulse withstand voltage	6 kV
Pollution degree	3
Overvoltage category	III
Clearance of open contact	3.6 mm

General data

Ambient temperature storage	-30 ... 80 °C
Ambient temperature operation open contact	-25 ... 55 °C
Ambient temperature operation close contact	-25 ... 45 °C
Conductor cross section Control / Main Circuit	4 mm ² / 6 mm ²
Nominal screw torque Control / Main Circuit	1.4 Nm / 1.4 Nm
Module width	fig. 3
Weight	300 g
Protection degree	IP 20
Housing material	PA 66

Product references

Main circuit	Product reference	24	230
3 NO + 1 NO	RSC16-310/AC...V	✓	✓
3 NO + 1 NC	RSC16-301/AC...V	✓	✓
3 NO	RSC16-300/DC...V	✓	

"..." list control circuit voltage to complete product references
Other voltages on request. Please contact support@comatreleco.com

Accessories

Auxiliary module	RSC-AUX
Bimetallic thermal relay	RSC-MP
RC - Suppressor	RSC-RC
DI - Suppressor	RMC-DI
MBL - Mechanical locking	RSC-MBL1



fig. 1. Wiring diagram

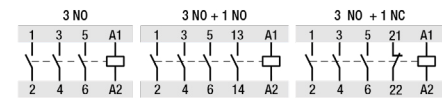


fig. 2. Electrical endurance

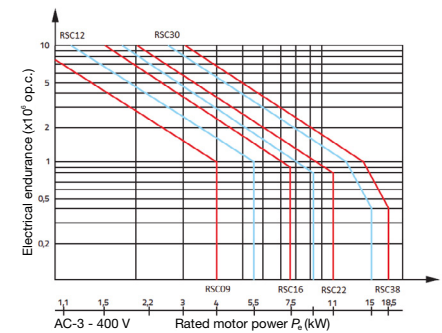
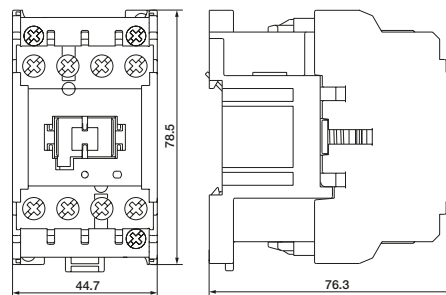


fig. 3. Dimensions (mm)



Standards and approvals

Standards IEC/EN 60947



RSC22

Industrial Contactor | 3 pole | 22 A | 11 kW

Main circuit

Contact material	AgNiO ₂
Rated voltage	1000 V
Rated current AC-1	35 A
Rated current AC-3	22 A, 400 V
Rated current DC-3	1 A, 220 V DC
Minimum contact load	50 mA, 17 V
Overload current	176 A (10 s) / 600 A (0.001 s)
Rated load AC-1, 400 V	23 kW
Rated load AC-3, 400 V	11 kW
Mechanical endurance (cycles)	≥ 1 x 10 ⁷
Electrical endurance at rated load AC-1 (cycles)	≥ 2 x 10 ⁵
Electrical endurance at rated load AC-3 (cycles)	fig. 2
Switching frequency at rated load AC-1 (cycles/h)	≤ 600
Switching frequency at rated load AC-3 (cycles/h)	≤ 600
Switching frequency at rated load DC-3	≤ 300

Control circuit

Nominal voltage	24 V AC, 230 V AC	24 V DC
Operating voltage range	0.85 ... 1.1 U _N	
Typ. pick-up voltage	≤ 0.85 U _N	
Typ. release voltage	≥ 0.2 U _N AC	≥ 0.1 U _N DC
Pick-up time	10 ... 20 ms	
Release time	5 ... 15 ms	
Power consumption AC / DC	8.0 VA / 2.5 W	
Rated frequency	50 / 60 Hz	

Insulation

Rated insulation voltage	1000 V
Rated impulse withstand voltage	6 kV
Pollution degree	3
Overvoltage category	III
Clearance of open contact	3.6 mm

General data

Ambient temperature storage	-30 ... 80 °C
Ambient temperature operation open contact	-25 ... 55 °C
Ambient temperature operation close contact	-25 ... 45 °C
Conductor cross section Control / Main Circuit	4 mm ² / 10 mm ²
Nominal screw torque Control / Main Circuit	1.4 Nm / 1.8 Nm
Module width	fig. 3
Weight	320 g
Protection degree	IP 20
Housing material	PA 66

Product references

Main circuit	Product reference	24	230
3 NO	RSC22-300/AC...V	✓	✓
3 NO	RSC22-300/DC...V	✓	

"..." list control circuit voltage to complete product references
Other voltages on request. Please contact support@comatreleco.com

Accessories

Auxiliary module	RSC-AUX
RC - Suppressor	RSC-RC
DI - Suppressor	RMC-DI
MBL - Mechanical locking	RSC-MBL1



fig. 1. Wiring diagram

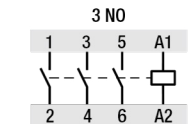


fig. 2. Electrical endurance

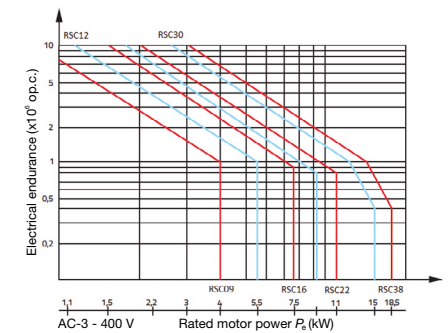
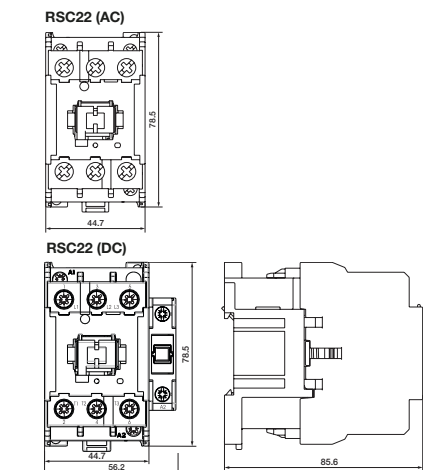


fig. 3. Dimensions (mm)



Standards and approvals

Standards IEC/EN 60947



RSC30

Industrial Contactor | 3 pole | 30 A | 15 kW

Main circuit

Contact material	AgNiO ₂
Rated voltage	1000 V
Rated current AC-1	35 A
Rated current AC-3	30 A, 400 V
Rated current DC-3	1 A, 220 V DC
Minimum contact load	50 mA, 17 V
Overload current	240 A (10 s) / 900 A (0.001 s)
Rated load AC-1, 400 V	23 kW
Rated load AC-3, 400 V	15 kW
Mechanical endurance (cycles)	≥ 1 x 10 ⁷
Electrical endurance at rated load AC-1 (cycles)	≥ 2 x 10 ⁵
Electrical endurance at rated load AC-3 (cycles)	fig. 2
Switching frequency at rated load AC-1 (cycles/h)	≤ 600
Switching frequency at rated load AC-3 (cycles/h)	≤ 600
Switching frequency at rated load DC-3	≤ 300

Control circuit

Nominal voltage	24 V AC, 230 V AC	24 V DC
Operating voltage range	0.85 ... 1.1 U _N	
Typ. pick-up voltage	≤ 0.85 U _N	
Typ. release voltage	≥ 0.2 U _N AC	≥ 0.1 U _N DC
Pick-up time	10 ... 20 ms	
Release time	5 ... 15 ms	
Power consumption AC / DC	8.0 VA / 2.5 W	
Rated frequency	50 / 60 Hz	

Insulation

Rated insulation voltage	1000 V
Rated impulse withstand voltage	6 kV
Pollution degree	3
Overvoltage category	III
Clearance of open contact	3.6 mm

General data

Ambient temperature storage	-30 ... 80 °C
Ambient temperature operation open contact	-25 ... 55 °C
Ambient temperature operation close contact	-25 ... 45 °C
Conductor cross section Control / Main Circuit	4 mm ² / 10 mm ²
Nominal screw torque Control / Main Circuit	1.4 Nm / 1.8 Nm
Module width	fig. 3
Weight	320 g
Protection degree	IP 20
Housing material	PA 66

Product references

Main circuit	Product reference	24	230
3 NO	RSC30-300/AC...V	✓	✓
3 NO	RSC30-300/DC...V	✓	

"..." list control circuit voltage to complete product references
Other voltages on request. Please contact support@comatreleco.com

Accessories

Auxiliary module	RSC-AUX
RC - Suppressor	RSC-RC
DI - Suppressor	RMC-DI
MBL - Mechanical locking	RSC-MBL1



fig. 1. Wiring diagram



fig. 2. Electrical endurance

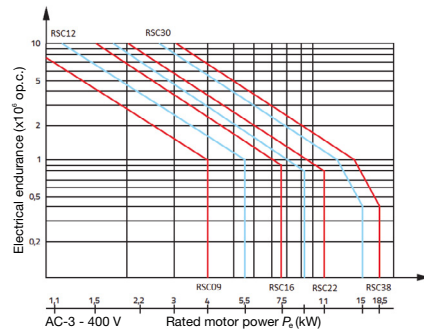
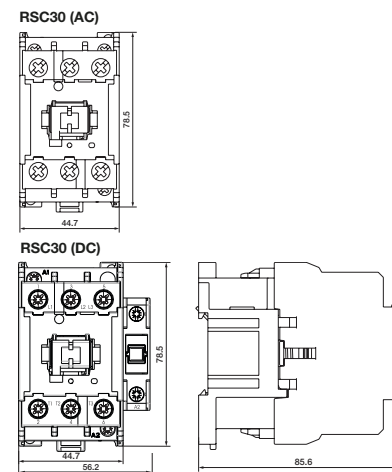


fig. 3. Dimensions (mm)



Standards and approvals

Standards IEC/EN 60947



RSC38

Industrial Contactor | 3 pole | 38 A | 18.5 kW

Main circuit

Contact material	AgNiO ₂
Rated voltage	1000 V
Rated current AC-1	45 A
Rated current AC-3	38 A, 400 V
Rated current DC-3	1 A, 220 V DC
Minimum contact load	50 mA, 17 V
Overload current	304 A (10 s) / 900 A (0.001 s)
Rated load AC-1, 400 V	29 kW
Rated load AC-3, 400 V	18.5 kW
Mechanical endurance (cycles)	≥ 1 x 10 ⁷
Electrical endurance at rated load AC-1 (cycles)	≥ 2 x 10 ⁵
Electrical endurance at rated load AC-3 (cycles)	fig. 2
Switching frequency at rated load AC-1 (cycles/h)	≤ 600
Switching frequency at rated load AC-3 (cycles/h)	≤ 600
Switching frequency at rated load DC-3	≤ 300

Control circuit

Nominal voltage	24 V AC, 230 V AC	24 V DC
Operating voltage range	0.85 ... 1.1 U _N	
Typ. pick-up voltage	≤ 0.85 U _N	
Typ. release voltage	≥ 0.2 U _N AC	≥ 0.1 U _N DC
Pick-up time	10 ... 20 ms	
Release time	5 ... 15 ms	
Power consumption AC / DC	10 VA / 2.5 W	
Rated frequency	50 / 60 Hz	

Insulation

Rated insulation voltage	1000 V
Rated impulse withstand voltage	6 kV
Pollution degree	3
Overvoltage category	III
Clearance of open contact	3.6 mm

General data

Ambient temperature storage	-30 ... 80 °C
Ambient temperature operation open contact	-25 ... 55 °C
Ambient temperature operation close contact	-25 ... 45 °C
Conductor cross section Control / Main Circuit	4 mm ² / 10 mm ²
Nominal screw torque Control / Main Circuit	1.4 Nm / 1.8 Nm
Module width	fig. 3
Weight	320 g
Protection degree	IP 20
Housing material	PA 66

Product references

Main circuit	Product reference	24	230
3 NO	RSC38-300/AC...V	✓	✓
3 NO	RSC38-300/DC...V	✓	

"..." list control circuit voltage to complete product references
Other voltages on request. Please contact support@comatreleco.com

Accessories

Auxiliary module	RSC-AUX
RC - Suppressor	RSC-RC
DI - Suppressor	RMC-DI
MBL - Mechanical locking	RSC-MBL1



fig. 1. Wiring diagram

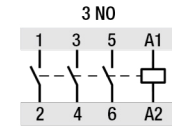


fig. 2. Electrical endurance

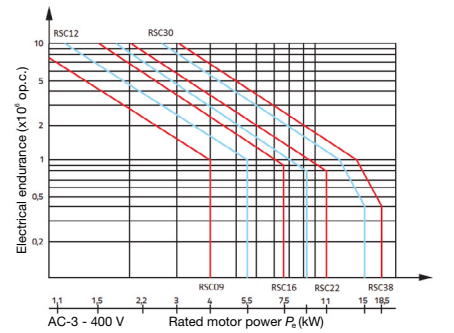
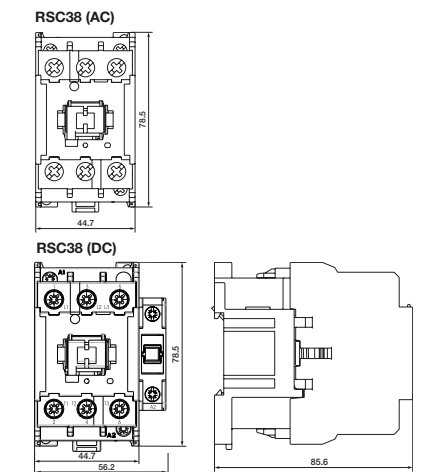


fig. 3. Dimensions (mm)



Standards and approvals

Standards IEC/EN 60947



RSC43

Industrial Contactor | 5 pole | 43 A | 22 kW

Main circuit

Contact material	AgNiO ₂
Rated voltage	1000 V
Rated current AC-1	75 A
Rated current AC-3	43 A, 400 V
Rated current DC-1	6 A, 220 V DC
Minimum contact load	50 mA, 17 V
Overload current	344 A (10 s)
Rated load AC-1, 400 V	56 kW
Rated load AC-3, 400 V	22 kW
Mechanical endurance (cycles)	≥ 3 x 10 ⁶
Electrical endurance at rated load AC-1 (cycles)	≥ 2 x 10 ⁵
Electrical endurance at rated load AC-3 (cycles)	fig. 2
Switching frequency at rated load AC-1 (cycles/h)	≤ 600
Switching frequency at rated load AC-3 (cycles/h)	≤ 600
Switching frequency at rated load DC-3	≤ 300

Control circuit

Nominal voltage	24 V AC, 230 V AC
Operating voltage range	0.85 ... 1.1 U _N
Typ. pick-up voltage	≤ 0.85 U _N
Typ. release voltage	≥ 0.2 U _N AC
Pick-up time	10 ... 20 ms
Release time	8 ... 15 ms
Power consumption AC	10 VA
Rated frequency	50 / 60 Hz

Insulation

Rated insulation voltage	1000 V
Rated impulse withstand voltage	6 kV
Pollution degree	3
Overvoltage category	III
Clearance of open contact	3.6 mm

General data

Ambient temperature storage	-30 ... 80 °C
Ambient temperature operation open contact	-20 ... 60 °C
Ambient temperature operation close contact	-20 ... 45 °C
Conductor cross section Control / Main Circuit	2.5 mm ² / 35 mm ²
Nominal screw torque Control / Main Circuit	0.8 Nm / 4 Nm
Module width	fig. 3
Weight	930 g
Protection degree	IP 20
Housing material	PA 66

Product references

Main circuit	Product reference	24	230
3 NO + 1 NO + 1 NC	RSC43-310/AC...V	✓	✓

"..." list control circuit voltage to complete product references
Other voltages on request. Please contact support@comatreleco.com

Accessories

Auxiliary module	RSC-AUX
RC - Suppressor	RSC-RC
DI - Suppressor	RMC-DI
MBL - Mechanical locking	RSC-MBL2



fig. 1. Wiring diagram

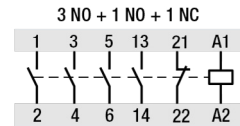


fig. 2. Electrical endurance

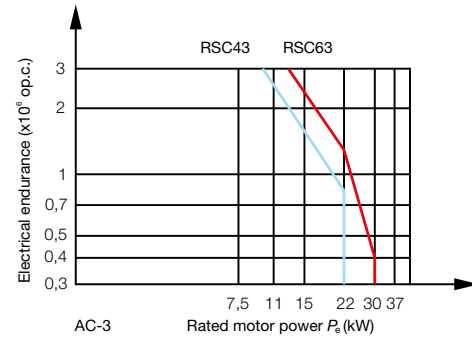
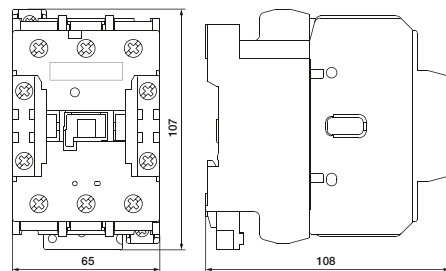


fig. 3. Dimensions (mm)



Standards and approvals

Standards IEC/EN 60947



RSC63

Industrial Contactor | 5 pole | 63 A | 30 kW

Main circuit

Contact material	AgNiO ₂
Rated voltage	1000 V
Rated current AC-1	85 A
Rated current AC-3	63 A, 400 V
Rated current DC-1	6 A, 220 V DC
Minimum contact load	50 mA, 17 V
Overload current	504 A (10 s)
Rated load AC-1, 400 V	66 kW
Rated load AC-3, 400 V	30 kW
Mechanical endurance (cycles)	≥ 3 x 10 ⁶
Electrical endurance at rated load AC-1 (cycles)	≥ 2 x 10 ⁵
Electrical endurance at rated load AC-3 (cycles)	fig. 2
Switching frequency at rated load AC-1 (cycles/h)	≤ 600
Switching frequency at rated load AC-3 (cycles/h)	≤ 600
Switching frequency at rated load DC-3	≤ 300

Control circuit

Nominal voltage	24 V AC, 230 V AC
Operating voltage range	0.85 ... 1.1 U _N
Typ. pick-up voltage	≤ 0.85 U _N
Typ. release voltage	≥ 0.2 U _N AC
Pick-up time	10 ... 20 ms
Release time	8 ... 15 ms
Power consumption AC	10 VA
Rated frequency	50 / 60 Hz

Insulation

Rated insulation voltage	1000 V
Rated impulse withstand voltage	6 kV
Pollution degree	3
Overvoltage category	III
Clearance of open contact	3.6 mm

General data

Ambient temperature storage	-30 ... 80 °C
Ambient temperature operation open contact	-20 ... 60 °C
Ambient temperature operation close contact	-20 ... 45 °C
Conductor cross section Control / Main Circuit	2.5 mm ² / 35 mm ²
Nominal screw torque Control / Main Circuit	0.8 Nm / 4 Nm
Module width	fig. 3
Weight	930 g
Protection degree	IP 20
Housing material	PA 66

Product references

Main circuit	Product reference	24	230
3 NO + 1 NO + 1 NC	RSC63-310/AC...V	✓	✓

"..." list control circuit voltage to complete product references
Other voltages on request. Please contact support@comatreleco.com

Accessories

Auxiliary module	RSC-AUX
RC - Suppressor	RSC-RC
DI - Suppressor	RMC-DI
MBL - Mechanical locking	RSC-MBL2



fig. 1. Wiring diagram

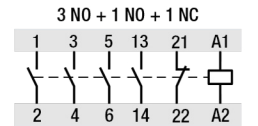


fig. 2. Electrical endurance

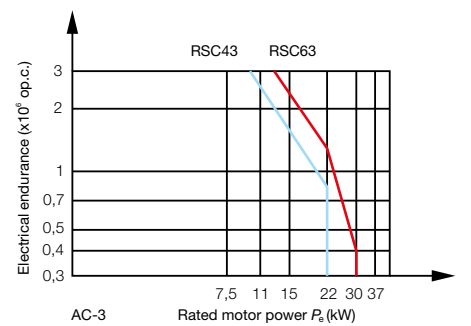
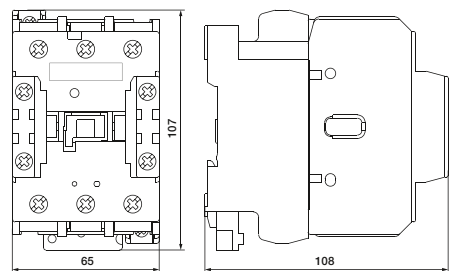


fig. 3. Dimensions (mm)



Standards and approvals

Standards IEC/EN 60947



RSC-MP

Bimetallic thermal relay | 5 pole | 0.1 ... 10 A | RSC09 ... RSC16

Main circuit

Contact material	AgNi
Rated voltage	690 V
Rated current AC-1	0.1 ... 10 A
Rated current auxiliary contact AC / DC	3 A, 230 V / 0.1 A, 230 V
Overload current	72 A (100 ms)
Tripping curve	fig. 2

Control circuit

Phase loss protection	Yes
Ambient temperature compensation	Yes
Reset mode	manual / automatic
Rated operational current auxiliary contact AC-15	3 A, 250 V

Insulation

Rated insulation voltage	690 V
Rated impulse withstand voltage	6 kV
Pollution degree	3
Overvoltage category	III

General data

Ambient temperature storage	-25 ... 70 °C
Ambient temperature operation	-5 ... 55 °C
Conductor cross section Auxiliary / Main Circuit	2.5 mm ² / 10 mm ²
Nominal screw torque Auxiliary / Main Circuit	0.8 Nm / 1.2 Nm
Module width	fig. 3
Weight	115 g
Protection degree	IP 20
Housing material	PA 66

Product references

Description	Product reference
Bimetallic thermal relay	RSC-MP-0.16
Bimetallic thermal relay	RSC-MP-0.25
Bimetallic thermal relay	RSC-MP-0.4
Bimetallic thermal relay	RSC-MP-0.5
Bimetallic thermal relay	RSC-MP-0.63
Bimetallic thermal relay	RSC-MP-0.8
Bimetallic thermal relay	RSC-MP-1.0
Bimetallic thermal relay	RSC-MP-1.3
Bimetallic thermal relay	RSC-MP-1.6
Bimetallic thermal relay	RSC-MP-2.0
Bimetallic thermal relay	RSC-MP-2.5
Bimetallic thermal relay	RSC-MP-3.2
Bimetallic thermal relay	RSC-MP-4.0
Bimetallic thermal relay	RSC-MP-4.8
Bimetallic thermal relay	RSC-MP-6.3
Bimetallic thermal relay	RSC-MP-7.5
Bimetallic thermal relay	RSC-MP-10.0

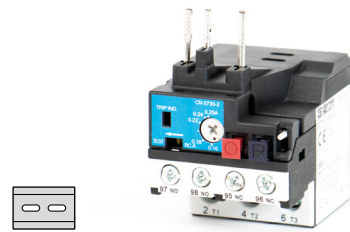


fig. 1. Wiring diagram

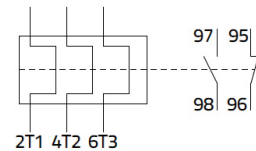


fig. 2. Electrical endurance

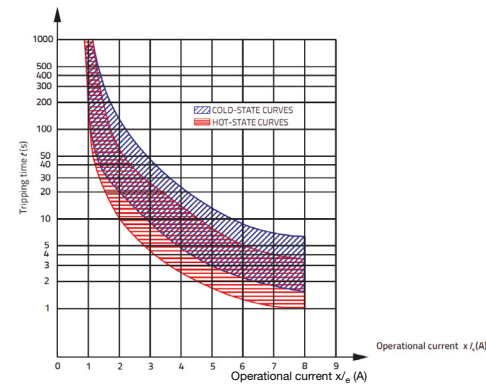
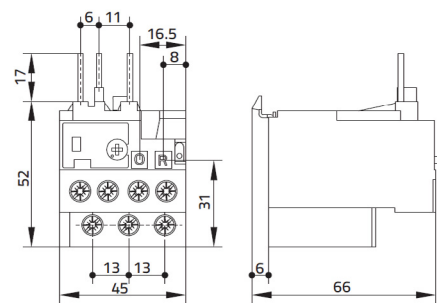


fig. 3. Dimensions (mm)



Standards and approvals

Standards IEC/EN 60947

Approvals CE cULus

RMC-AUX

Auxiliary module for industrial contactors | 2 or 4 pole | 6 A

Main circuit

Contact material	AgNi
Rated voltage	690 V
Rated current AC-1	20 A
Rated current AC-15	6 A, 230 V
Rated current DC-13	0.15 A, 110 V DC
Minimum contact load	50 mA, 17 V
Mechanical endurance (cycles)	≥ 1 x 10 ⁷
Electrical endurance at rated load AC-15 (cycles)	≥ 5 x 10 ⁵
Electrical endurance at rated load DC-13	≥ 5 x 10 ⁵
Switching frequency at rated load AC-15 (cycles/h)	≤ 1200
Switching frequency at rated load DC-13	≤ 1200

Insulation

Rated insulation voltage	690 V
Rated impulse withstand voltage	6 kV
Pollution degree	3

General data

Ambient temperature storage	-30 ... 80 °C
Conductor cross section Control / Main Circuit	- mm ² / 2.5 mm ²
Nominal screw torque Control / Main Circuit	- Nm / 1.2 Nm
Module width	fig. 2
Weight	20 g (2 pole) / 36 g (4 pole)
Protection degree	IP 20
Housing material	PA 66

Product references

Main circuit	Product reference
2 NO	RMC-AUX20
2 NC	RMC-AUX02
1 NO + 1 NC	RMC-AUX11
4 NO	RMC-AUX40
4 NC	RMC-AUX04
2 NO + 2 NC	RMC-AUX22



fig. 1. Wiring diagram

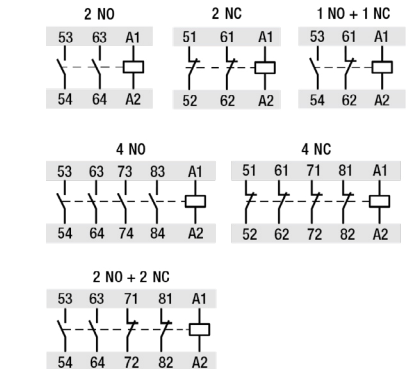
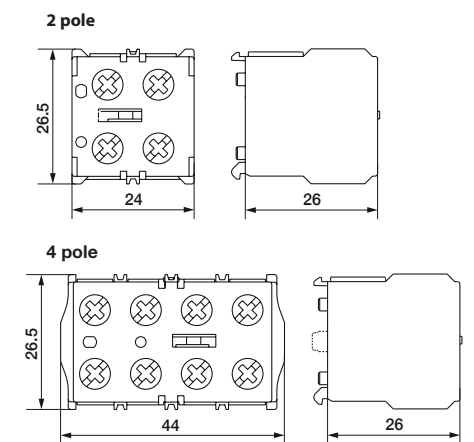


fig. 2. Dimensions (mm)



Standards and approvals

Standards IEC/EN 60947

Approvals CE cULus

RSC-AUX

Auxiliary module for industrial contactors | 2 or 4 pole | 6 A

Main circuit

Contact material	AgNi
Rated voltage	690 V
Rated current AC-1	20 A
Rated current AC-15	6 A, 230 V
Rated current DC-13	0.15 A, 110 V DC
Minimum contact load	50 mA, 17 V
Mechanical endurance (cycles)	≥ 1 x 10 ⁷
Electrical endurance at rated load AC-15 (cycles)	≥ 5 x 10 ⁵
Electrical endurance at rated load DC-13	≥ 5 x 10 ⁵
Switching frequency at rated load AC-15(cycles/h)	≤ 1200
Switching frequency at rated load DC-13	≤ 1200

Insulation

Rated insulation voltage	690 V
Rated impulse withstand voltage	6 kV
Pollution degree	3

General data

Ambient temperature storage	-30 ... 80 °C
Conductor cross section Control / Main Circuit	- mm ² / 2.5 mm ²
Nominal screw torque Control / Main Circuit	- Nm / 1.2 Nm
Module width	fig. 2
Weight	20 g (2 pole) / 36 g (4 pole)
Protection degree	IP 20
Housing material	PA 66

Product references

Main circuit	Product reference
2 NO	RSC-AUX20
2 NC	RSC-AUX02
1 NO + 1 NC	RSC-AUX11
4 NO	RSC-AUX40
4 NC	RSC-AUX04
2 NO + 2 NC	RSC-AUX22



fig. 1. Wiring diagram

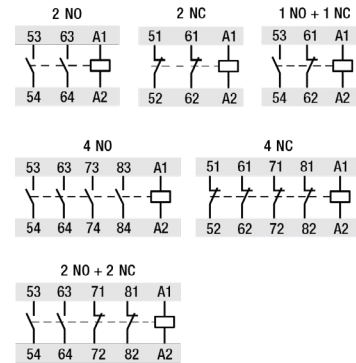
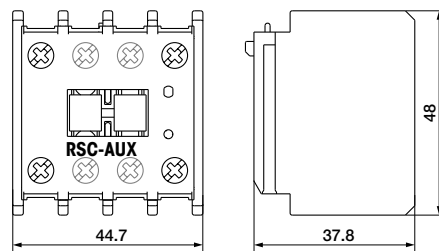


fig. 2. Dimensions (mm)



Standards and approvals

Standards IEC/EN 60947

Approvals CE

RMC-RC

RC - Suppressor

Control circuit

Operating voltage range	12 - 48 V AC / 48 - 250 V AC
-------------------------	------------------------------

General data

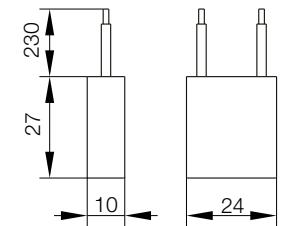
Module width	fig. 1
Weight	16 g

Product references

Description	Product reference
RC - Suppressor 12 - 48 V	RMC-RC1
RC - Suppressor 48 - 250 V	RMC-RC2



fig. 1. Dimensions (mm)



RSC-RC

RC - Suppressor

Control circuit	
Operating voltage range	12 - 48 V AC / 48 - 250 V AC

General data	
Module width	fig. 1
Weight	16 g

Product references	
Description	Product reference
RC - Suppressor 12 - 48 V	RSC-RC1
RC - Suppressor 48 - 250 V	RSC-RC2

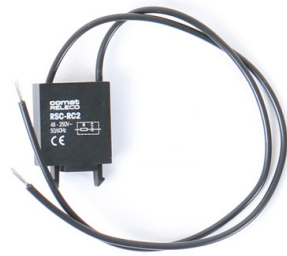
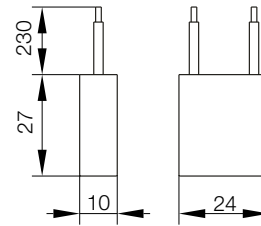


fig. 1. Dimensions (mm)



RMC-DI

DI - Suppressor

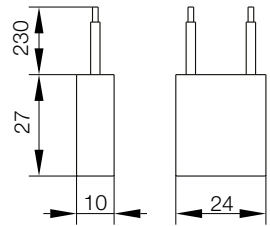
Control circuit	
Operating voltage range	6 - 250 V DC

General data	
Module width	fig. 1
Weight	16 g

Product references	
Description	Product reference
RC - Suppressor Diode 6 - 250 V	RMC-DI



fig. 1. Dimensions (mm)



RSC-MBL

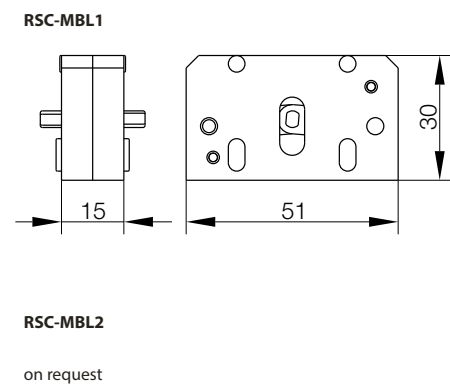
MBL - Mechanical locking

General data	
Module width	15 mm
Weight	14 g 16 g

Product references	
Description	Product reference
RSC - Mechanical locking	RSC-MBL1
RSC - Mechanical locking RSC43 / 63	RSC-MBL2



fig. 1. Dimensions (mm)



1.9 Solid State Contactors

Application	Type	Output	Page
CC1 Series			
Solid State Contactor 230 V 15 A	CC1H215	1	132
Solid State Contactor 230 V 30 A	CC1H230	1	133
Solid State Contactor 230 V 50 A	CC1H250	1	134
Solid State Contactor 400 V 15 A	CC1H415	1	135
Solid State Contactor 400 V 30 A	CC1H430	1	136
Solid State Contactor 400 V 50 A	CC1H450	1	137
CC3 Series			
Solid State Contactor 400 V 10 A	CC3H410	3	138
Solid State Contactor 400 V 20 A	CC3H420	3	139
Solid State Contactor 400 V 10 A Reversing	CCR3H410	3	140
CPC Series			
Solid State Power Controller 230 V 30 A	CPC1230	1	141
Solid State Power Controller 230 V 50 A	CPC1250	1	142
Solid State Power Controller 400 V 30 A	CPC1430	1	143
Solid State Power Controller 400 V 50 A	CPC1450	1	144

CC1H215

Solid State Contactor | 1 phase | 230 V | 15 A

Main circuit	
Output type	Thyristor
Number of outputs	1
Rated voltage	230 V
Output voltage range	12 ... 240 V AC
Reverse voltage	1000 V _{rrm}
Peak reverse voltage	1100 V _{rrm}
Rated current AC-1	15 A
Rated current AC-3	15 A
Minimum load	10 mA
Typ. leakage current	1 mA
Rated limit load	1800 A ² t

Control circuit	
Nominal voltage	24 ... 230 V UC
Operating voltage range	0.85 ... 1.1 U _N
Typ. pick-up voltage	20.4 V
Typ. release voltage	7.2 V
Pick-up time	20 ms
Release time	20 ms
Power consumption AC / DC	1.5 VA / 150 mW
Rated frequency	50 / 60 Hz

Insulation	
Rated insulation voltage	660 V
Rated impulse withstand voltage	4 kV
Pollution degree	3
Overvoltage category	III

General data	
Ambient temperature storage	-20 ... 80 °C
Ambient temperature operation	-5 ... 40 °C
Ambient temperature operation derated power	-5 ... 60 °C, 0.7 I _N
Conductor cross section Control / Main Circuit	1.5 mm ² / 10 mm ²
Nominal screw torque Control / Main Circuit	0.5 Nm / 1.2 Nm
Module width	fig. 2
Weight	270 g
Protection degree	IP 20
Housing material	PPE
Mounting	TS 35 or Back Panel Mounting

Product references	
Description	Product reference
Solid State Contactor, 1 phase	CC1H215

Other devices on request. Please contact support@comatreleco.com.

Accessories	
Thermal overload protection	P82-100C



fig. 1. Wiring diagram

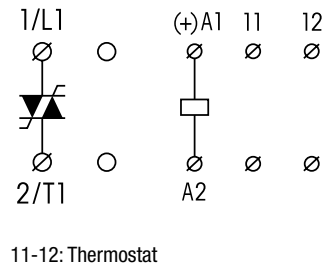
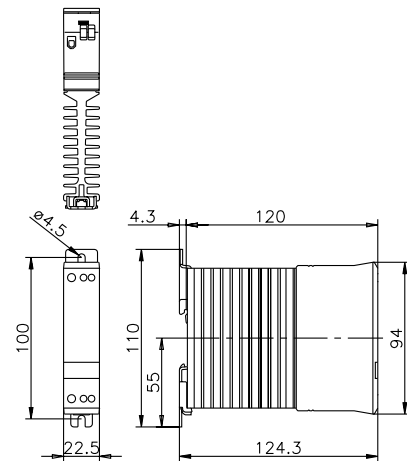


fig. 2. Dimensions (mm)



Standards and approvals

Standards IEC/EN 60947, 50022, 60068



CC1H230

Solid State Contactor | 1 phase | 230 V | 30 A

Main circuit	
Output type	Thyristor
Number of outputs	1
Rated voltage	230 V
Output voltage range	12 ... 240 V AC
Reverse voltage	1000 V _{rrm}
Peak reverse voltage	1100 V _{rrm}
Rated current AC-1	30 A
Rated current AC-3	15 A
Minimum load	10 mA
Typ. leakage current	1 mA
Rated limit load	1800 A ² t

Control circuit	
Nominal voltage	24 ... 230 V UC
Operating voltage range	0.85 ... 1.1 U _N
Typ. pick-up voltage	20.4 V
Typ. release voltage	7.2 V
Pick-up time	20 ms
Release time	20 ms
Power consumption AC / DC	1.5 VA / 150 mW
Rated frequency	50 / 60 Hz

Insulation	
Rated insulation voltage	660 V
Rated impulse withstand voltage	4 kV
Pollution degree	3
Overvoltage category	III

General data	
Ambient temperature storage	-20 ... 80 °C
Ambient temperature operation	-5 ... 40 °C
Ambient temperature operation derated power	-5 ... 60 °C, 0.7 I _N
Conductor cross section Control / Main Circuit	1.5 mm ² / 10 mm ²
Nominal screw torque Control / Main Circuit	0.5 Nm / 1.2 Nm
Module width	fig. 2
Weight	650 g
Protection degree	IP 20
Housing material	PPE
Mounting	TS 35 or Back Panel Mounting

Product references	
Description	Product reference
Solid State Contactor, 1 phase	CC1H230

Other devices on request. Please contact support@comatreleco.com.

Accessories	
Thermal overload protection	P82-100C

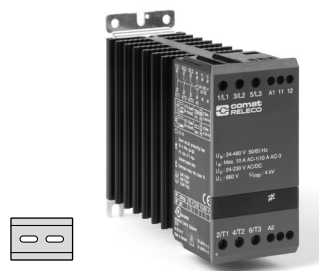


fig. 1. Wiring diagram

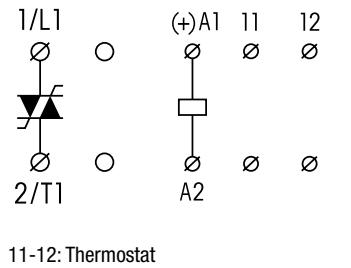
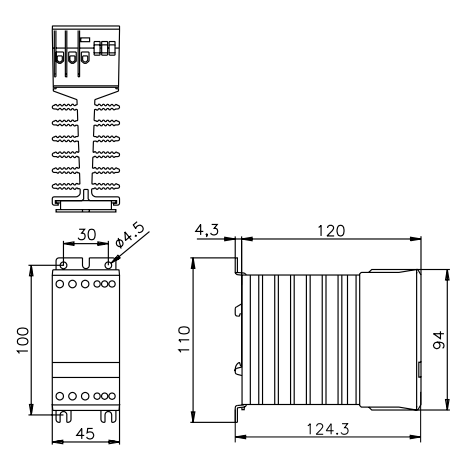


fig. 2. Dimensions (mm)



Standards and approvals

Standards IEC/EN 60947, 50022, 60068



CC1H250

Solid State Contactor | 1 phase | 230 V | 50 A

Main circuit	
Output type	Thyristor
Number of outputs	1
Rated voltage	230 V
Output voltage range	12 ... 240 V AC
Reverse voltage	1000 V _{rrm}
Peak reverse voltage	1100 V _{rrm}
Rated current AC-1	50 A
Rated current AC-3	15 A
Minimum load	10 mA
Typ. leakage current	1 mA
Rated limit load	1800 A ² t

Control circuit	
Nominal voltage	24 ... 230 V UC
Operating voltage range	0.85 ... 1.1 U _N
Typ. pick-up voltage	20.4 V
Typ. release voltage	7.2 V
Pick-up time	20 ms
Release time	20 ms
Power consumption AC / DC	1.5 VA / 150 mW
Rated frequency	50 / 60 Hz

Insulation	
Rated insulation voltage	660 V
Rated impulse withstand voltage	4 kV
Pollution degree	3
Overvoltage category	III

General data	
Ambient temperature storage	-20 ... 80 °C
Ambient temperature operation	-5 ... 40 °C
Ambient temperature operation derated power	-5 ... 60 °C, 0.7 I _N
Conductor cross section Control / Main Circuit	1.5 mm ² / 10 mm ²
Nominal screw torque Control / Main Circuit	0.5 Nm / 1.2 Nm
Module width	fig. 2
Weight	1050 g
Protection degree	IP 20
Housing material	PPE
Mounting	TS 35 or Back Panel Mounting

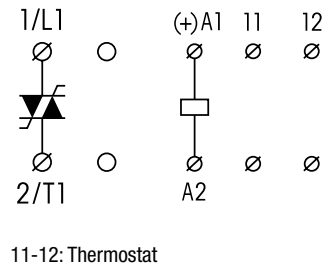
Product references	
Description	Product reference
Solid State Contactor, 1 phase	CC1H250

Other devices on request. Please contact support@comatreleco.com.

Accessories	
Thermal overload protection	P82-100C

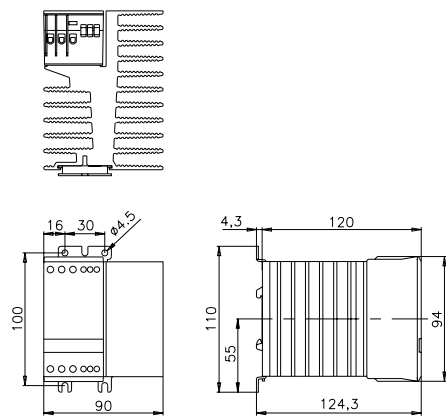


fig. 1. Wiring diagram



11-12: Thermostat

fig. 2. Dimensions (mm)



Standards and approvals

Standards IEC/EN 60947, 50022, 60068



CC1H415

Solid State Contactor | 1 phase | 400 V | 15 A

Main circuit	
Output type	Thyristor
Number of outputs	1
Rated voltage	400 V
Output voltage range	24 ... 480 VAC
Reverse voltage	1200 V _{rrm}
Peak reverse voltage	1300 V _{rrm}
Rated current AC-1	15 A
Rated current AC-3	15 A
Minimum load	10 mA
Typ. leakage current	1 mA
Rated limit load	1800 A ² t

Control circuit	
Nominal voltage	24 ... 230 V UC
Operating voltage range	0.85 ... 1.1 U _N
Typ. pick-up voltage	20.4 V
Typ. release voltage	7.2 V
Pick-up time	20 ms
Release time	20 ms
Power consumption AC / DC	1.5 VA / 150 mW
Rated frequency	50 / 60 Hz

Insulation	
Rated insulation voltage	660 V
Rated impulse withstand voltage	4 kV
Pollution degree	3
Overvoltage category	III

General data	
Ambient temperature storage	-20 ... 80 °C
Ambient temperature operation	-5 ... 40 °C
Ambient temperature operation derated power	-5 ... 60 °C, 0.7 I _N
Conductor cross section Control / Main Circuit	1.5 mm ² / 10 mm ²
Nominal screw torque Control / Main Circuit	0.5 Nm / 1.2 Nm
Module width	fig. 2
Weight	270 g
Protection degree	IP 20
Housing material	PPE
Mounting	TS 35 or Back Panel Mounting

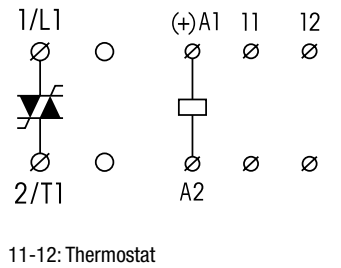
Product references	
Description	Product reference
Solid State Contactor, 1 phase	CC1H415

Other devices on request. Please contact support@comatreleco.com.

Accessories	
Thermal overload protection	P82-100C

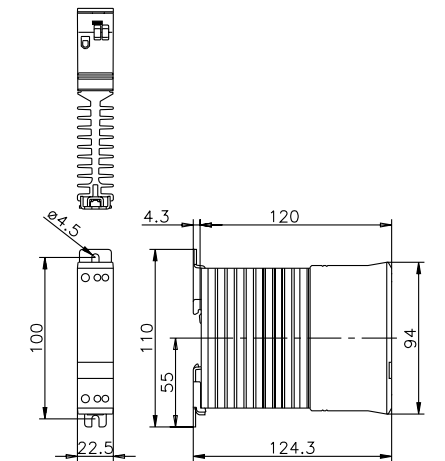


fig. 1. Wiring diagram



11-12: Thermostat

fig. 2. Dimensions (mm)



Standards and approvals

Standards IEC/EN 60947, 50022, 60068



CC1H430

Solid State Contactor | 1 phase | 400 V | 30 A

Main circuit	
Output type	Thyristor
Number of outputs	1
Rated voltage	400 V
Output voltage range	24 ... 480 VAC
Reverse voltage	1200 V _{rrm}
Peak reverse voltage	1300 V _{rrm}
Rated current AC-1	30 A
Rated current AC-3	15 A
Minimum load	10 mA
Typ. leakage current	1 mA
Rated limit load	1800 A ² t

Control circuit	
Nominal voltage	24 ... 230 V UC
Operating voltage range	0.85 ... 1.1 U _N
Typ. pick-up voltage	20.4 V
Typ. release voltage	7.2 V
Pick-up time	20 ms
Release time	20 ms
Power consumption AC / DC	1.5 VA / 150 mW
Rated frequency	50 / 60 Hz

Insulation	
Rated insulation voltage	660 V
Rated impulse withstand voltage	4 kV
Pollution degree	3
Overvoltage category	III

General data	
Ambient temperature storage	-20 ... 80 °C
Ambient temperature operation	-5 ... 40 °C
Ambient temperature operation derated power	-5 ... 60 °C, 0.7 I _N
Conductor cross section Control / Main Circuit	1.5 mm ² / 10 mm ²
Nominal screw torque Control / Main Circuit	0.5 Nm / 1.2 Nm
Module width	fig. 2
Weight	650 g
Protection degree	IP 20
Housing material	PPE
Mounting	TS 35 or Back Panel Mounting

Product references	
Description	Product reference
Solid State Contactor, 1 phase	CC1H430

Other devices on request. Please contact support@comatreleco.com.

Accessories	
Thermal overload protection	P82-100C



fig. 1. Wiring diagram

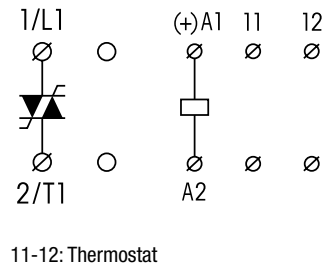
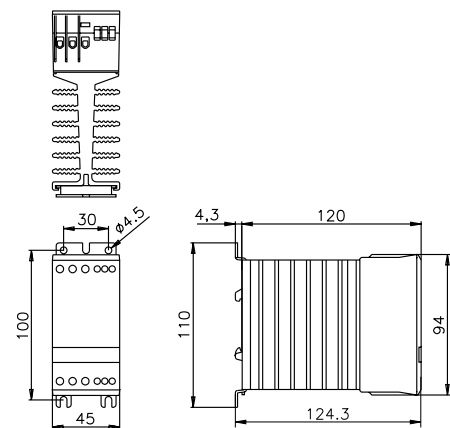


fig. 2. Dimensions (mm)



Standards and approvals

Standards IEC/EN 60947, 50022, 60068



CC1H450

Solid State Contactor | 1 phase | 400 V | 50 A

Main circuit	
Output type	Thyristor
Number of outputs	1
Rated voltage	400 V
Output voltage range	24 ... 480 VAC
Reverse voltage	1200 V _{rrm}
Peak reverse voltage	1300 V _{rrm}
Rated current AC-1	50 A
Rated current AC-3	15 A
Minimum load	10 mA
Typ. leakage current	1 mA
Rated limit load	1800 A ² t

Control circuit	
Nominal voltage	24 ... 230 V UC
Operating voltage range	0.85 ... 1.1 U _N
Typ. pick-up voltage	20.4 V
Typ. release voltage	7.2 V
Pick-up time	20 ms
Release time	20 ms
Power consumption AC / DC	1.5 VA / 150 mW
Rated frequency	50 / 60 Hz

Insulation	
Rated insulation voltage	660 V
Rated impulse withstand voltage	4 kV
Pollution degree	3
Overvoltage category	III

General data	
Ambient temperature storage	-20 ... 80 °C
Ambient temperature operation	-5 ... 40 °C
Ambient temperature operation derated power	-5 ... 60 °C, 0.7 I _N
Conductor cross section Control / Main Circuit	1.5 mm ² / 10 mm ²
Nominal screw torque Control / Main Circuit	0.5 Nm / 1.2 Nm
Module width	fig. 2
Weight	1050 g
Protection degree	IP 20
Housing material	PPE
Mounting	TS 35 or Back Panel Mounting

Product references	
Description	Product reference
Solid State Contactor, 1 phase	CC1H450

Other devices on request. Please contact support@comatreleco.com.

Accessories	
Thermal overload protection	P82-100C



fig. 1. Wiring diagram

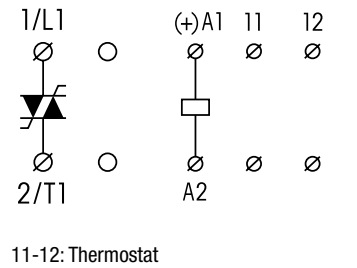
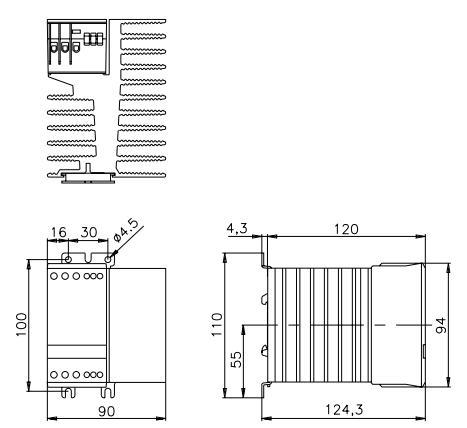


fig. 2. Dimensions (mm)



Standards and approvals

Standards IEC/EN 60947, 50022, 60068



CC3H410

Solid State Contactor | 3 phase | 400 V | 10 A

Main circuit	
Output type	Thyristor
Number of outputs	3
Rated voltage	400 V
Output voltage range	24 ... 480 VAC
Reverse voltage	1200 V _{rrm}
Peak reverse voltage	1300 V _{rrm}
Rated current AC-1	10 A
Rated current AC-3	10 A
Minimum load	10 mA
Typ. leakage current	1 mA
Rated limit load	610 A ² t

Control circuit	
Nominal voltage	24 ... 230 V UC
Operating voltage range	0.85 ... 1.1 U _N
Typ. pick-up voltage	20.4 V
Typ. release voltage	7.2 V
Pick-up time	20 ms
Release time	20 ms
Power consumption AC / DC	1.5 VA / 150 mW
Rated frequency	50 / 60 Hz

Insulation	
Rated insulation voltage	660 V
Rated impulse withstand voltage	4 kV
Pollution degree	3
Overvoltage category	III

General data	
Ambient temperature storage	-20 ... 80 °C
Ambient temperature operation	-5 ... 40 °C
Ambient temperature operation derated power	-5 ... 60 °C, 0.7 I _N
Conductor cross section Control / Main Circuit	1.5 mm ² / 10 mm ²
Nominal screw torque Control / Main Circuit	0.5 Nm / 1.2 Nm
Module width	fig. 2
Weight	650 g
Protection degree	IP 20
Housing material	PPE
Mounting	TS 35 or Back Panel Mounting

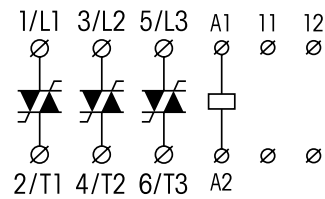
Product references	
Description	Product reference
Solid State Contactor, 3 phase	CC3H410

Other devices on request. Please contact support@comatreleco.com.

Accessories	
Thermal overload protection	P82-100C

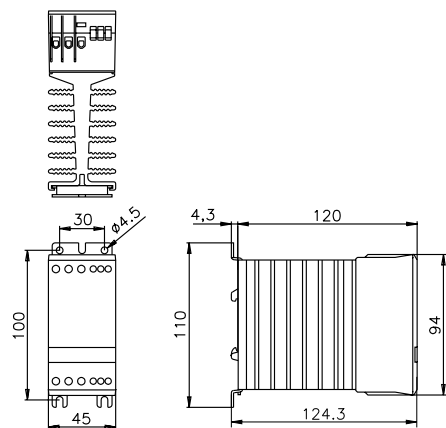


fig. 1. Wiring diagram



11-12: Thermostat

fig. 2. Dimensions (mm)



Standards and approvals

Standards IEC/EN 60947, 50022, 60068



CC3H420

Solid State Contactor | 3 phase | 400 V | 20 A

Main circuit	
Output type	Thyristor
Number of outputs	3
Rated voltage	400 V
Output voltage range	24 ... 480 VAC
Reverse voltage	1200 V _{rrm}
Peak reverse voltage	1300 V _{rrm}
Rated current AC-1	20 A
Rated current AC-3	10 A
Minimum load	10 mA
Typ. leakage current	1 mA
Rated limit load	610 A ² t

Control circuit	
Nominal voltage	24 ... 230 V UC
Operating voltage range	0.85 ... 1.1 U _N
Typ. pick-up voltage	20.4 V
Typ. release voltage	7.2 V
Pick-up time	20 ms
Release time	20 ms
Power consumption AC / DC	1.5 VA / 150 mW
Rated frequency	50 / 60 Hz

Insulation	
Rated insulation voltage	660 V
Rated impulse withstand voltage	4 kV
Pollution degree	3
Overvoltage category	III

General data	
Ambient temperature storage	-20 ... 80 °C
Ambient temperature operation	-5 ... 40 °C
Ambient temperature operation derated power	-5 ... 60 °C, 0.7 I _N
Conductor cross section Control / Main Circuit	1.5 mm ² / 10 mm ²
Nominal screw torque Control / Main Circuit	0.5 Nm / 1.2 Nm
Module width	fig. 2
Weight	1050 g
Protection degree	IP 20
Housing material	PPE
Mounting	TS 35 or Back Panel Mounting

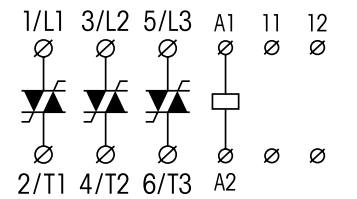
Product references	
Description	Product reference
Solid State Contactor, 3 phase	CC3H420

Other devices on request. Please contact support@comatreleco.com.

Accessories	
Thermal overload protection	P82-100C

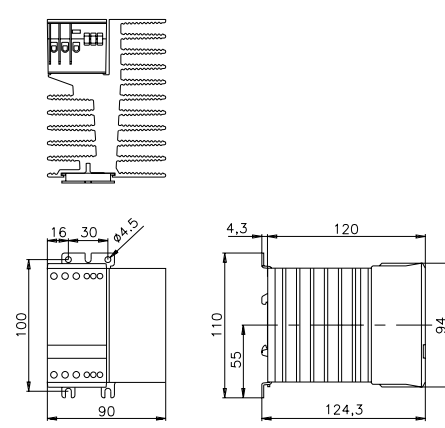


fig. 1. Wiring diagram



11-12: Thermostat

fig. 2. Dimensions (mm)



Standards and approvals

Standards IEC/EN 60947, 50022, 60068



CCR3H410

Solid State Contactor | Reversing | 3 phase | 400 V | 10 A

Main circuit	
Output type	Thyristor
Number of outputs	3
Rated voltage	400 V
Output voltage range	24 ... 480 VAC
Reverse voltage	1200 Vrrm
Peak reverse voltage	1300 Vrrm
Rated current AC-1	10 A
Rated current AC-3	10 A
Minimum load	10 mA
Typ. leakage current	1 mA
Rated limit load	610 A ² t

Control circuit	
Nominal voltage	24 ... 230 V UC
Operating voltage range	0.85 ... 1.1 U _N
Typ. pick-up voltage	20.4 V
Typ. release voltage	7.2 V
Pick-up time	20 ms
Release time	20 ms
Interlock time	150 ms
Power consumption AC / DC	1.5 VA / 150 mW
Rated frequency	50 / 60 Hz

Insulation	
Rated insulation voltage	660 V
Rated impulse withstand voltage	4 kV
Pollution degree	3
Overtoltage category	III

General data	
Ambient temperature storage	-20 ... 80 °C
Ambient temperature operation	-5 ... 40 °C
Ambient temperature operation derated power	-5 ... 60 °C, 0.7 I _N
Conductor cross section Control / Main Circuit	1.5 mm ² / 10 mm ²
Nominal screw torque Control / Main Circuit	0.5 Nm / 1.2 Nm
Module width	fig. 2
Weight	650 g
Protection degree	IP 20
Housing material	PPE
Mounting	TS 35 or Back Panel Mounting

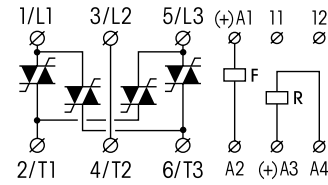
Product references	
Description	Product reference
Solid State Contactor - Reversing, 3 phase	CCR3H410

Other devices on request. Please contact support@comatreleco.com.

Accessories	
Thermal overload protection	P82-100C

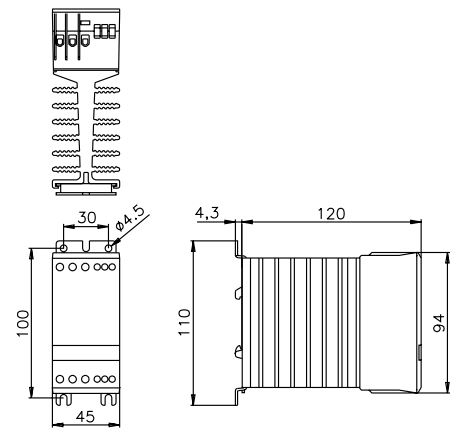


fig. 1. Wiring diagram



11-12: Thermostat

fig. 2. Dimensions (mm)



Standards and approvals

Standards IEC/EN 60947, 50022, 60068



CPC1230

Solid State Power Controller | 1 phase | 230 V | 30 A

Main circuit	
Output type	Thyristor
Number of outputs	1
Rated voltage	230 V
Output voltage range	380 ... 480 V
Reverse voltage	1000 Vrrm
Peak reverse voltage	1100 Vrrm
Rated current AC-1	30 A
Minimum load	10 mA
Typ. leakage current	1 mA
Rated limit load	1800 A ² t

Control circuit	
Nominal voltage	24 V UC
Operating voltage range	0.5 ... 1.5 U _N
Typ. pick-up voltage	≤ 12 V
Typ. release voltage	≥ 12 V
Pick-up time	20 ms
Release time	20 ms
Control input	0 ... 20 mA / 4 ... 20 mA / 0 - 10 V
Potentiometer_input	0 - 10 kOhm

Insulation	
Rated insulation voltage	660 V
Rated impulse withstand voltage	4 kV
Pollution degree	3
Overtoltage category	III

General data	
Ambient temperature storage	-20 ... 80 °C
Ambient temperature operation	-5 ... 40 °C
Ambient temperature operation derated power	-5 ... 60 °C, 0.7 I _N
Conductor cross section Control / Main Circuit	1.5 mm ² / 10 mm ²
Nominal screw torque Control / Main Circuit	0.5 Nm / 1.2 Nm
Module width	fig. 2
Weight	650 g
Protection degree	IP 20
Housing material	PPE
Mounting	TS 35 or Back Panel Mounting

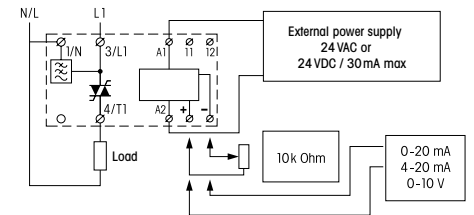
Product references	
Description	Product reference
Power Controller, 1 phase	CPC1230

Other devices on request. Please contact support@comatreleco.com.

Accessories	
Thermal overload protection	P82-100C

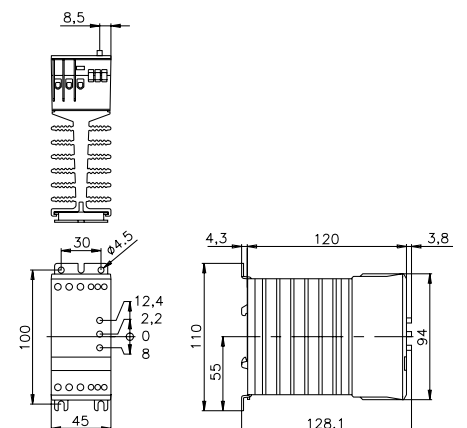


fig. 1. Wiring diagram



11-12: Thermostat

fig. 2. Dimensions (mm)



Standards and approvals

Standards IEC/EN 60947, 50022, 60068



CPC1250

Solid State Power Controller | 1 phase | 230 V | 50 A

Main circuit	
Output type	Thyristor
Number of outputs	1
Rated voltage	230 V
Output voltage range	380 ... 480 V
Reverse voltage	1000 V _{rrm}
Peak reverse voltage	1100 V _{rrm}
Rated current AC-1	50 A
Minimum load	10 mA
Typ. leakage current	1 mA
Rated limit load	1800 A ² t

Control circuit	
Nominal voltage	24 V UC
Operating voltage range	0.5 ... 1.5 U _N
Typ. pick-up voltage	≤ 12 V
Typ. release voltage	≥ 12 V
Pick-up time	20 ms
Release time	20 ms
Control input	0 ... 20 mA / 4 ... 20 mA / 0 - 10 V
Potentiometer_input	0 - 10 kOhm

Insulation	
Rated insulation voltage	660 V
Rated impulse withstand voltage	4 kV
Pollution degree	3
Overvoltage category	III

General data	
Ambient temperature storage	-20 ... 80 °C
Ambient temperature operation	-5 ... 40 °C
Ambient temperature operation derated power	-5 ... 60 °C, 0.7 I _N
Conductor cross section Control / Main Circuit	1.5 mm ² / 10 mm ²
Nominal screw torque Control / Main Circuit	0.5 Nm / 1.2 Nm
Module width	fig. 2
Weight	650 g
Protection degree	IP 20
Housing material	PPE
Mounting	TS 35 or Back Panel Mounting

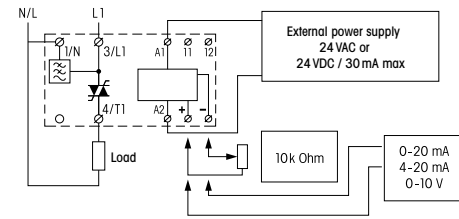
Product references	
Description	Product reference
Power Controller, 1 phase	CPC1250

Other devices on request. Please contact support@comatreleco.com.

Accessories	
Thermal overload protection	P82-100C

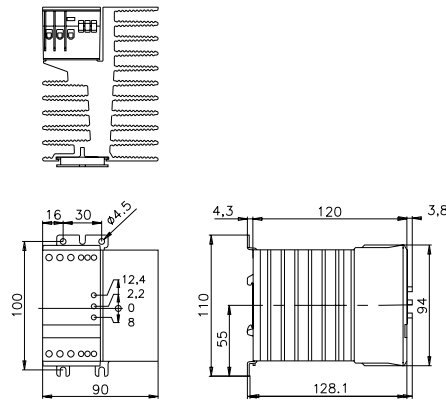


fig. 1. Wiring diagram



11-12: Thermostat

fig. 2. Dimensions (mm)



Standards and approvals

Standards IEC/EN 60947, 50022, 60068



CPC1430

Solid State Power Controller | 1 phase | 400 V | 30 A

Main circuit	
Output type	Thyristor
Number of outputs	1
Rated voltage	400 V
Output voltage range	380 ... 480 V
Reverse voltage	1200 V _{rrm}
Peak reverse voltage	1300 V _{rrm}
Rated current AC-1	30 A
Minimum load	10 mA
Typ. leakage current	1 mA
Rated limit load	1800 A ² t

Control circuit	
Nominal voltage	24 V UC
Operating voltage range	0.5 ... 1.5 U _N
Typ. pick-up voltage	≤ 12 V
Typ. release voltage	≥ 12 V
Pick-up time	20 ms
Release time	20 ms
Control input	0 ... 20 mA / 4 ... 20 mA / 0 - 10 V
Potentiometer_input	0 - 10 kOhm

Insulation	
Rated insulation voltage	660 V
Rated impulse withstand voltage	4 kV
Pollution degree	3
Overvoltage category	III

General data	
Ambient temperature storage	-20 ... 80 °C
Ambient temperature operation	-5 ... 40 °C
Ambient temperature operation derated power	-5 ... 60 °C, 0.7 I _N
Conductor cross section Control / Main Circuit	1.5 mm ² / 10 mm ²
Nominal screw torque Control / Main Circuit	0.5 Nm / 1.2 Nm
Module width	fig. 2
Weight	650 g
Protection degree	IP 20
Housing material	PPE
Mounting	TS 35 or Back Panel Mounting

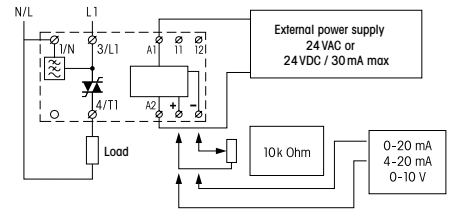
Product references	
Description	Product reference
Power Controller, 1 phase	CPC1430

Other devices on request. Please contact support@comatreleco.com.

Accessories	
Thermal overload protection	P82-100C

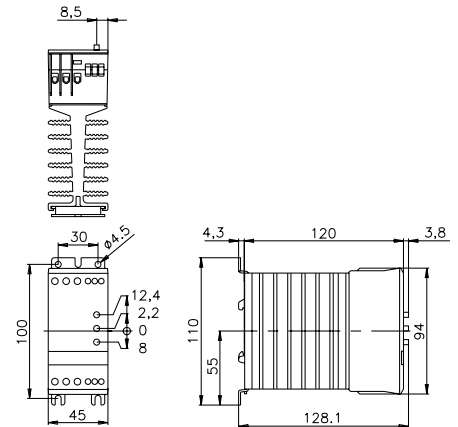


fig. 1. Wiring diagram



11-12: Thermostat

fig. 2. Dimensions (mm)



Standards and approvals

Standards IEC/EN 60947, 50022, 60068



CMD11-A

Off delay | single voltage | 1 CO

Time data	
Timing functions	A
Timing range	50 ms ... 60 min
Timing scale	0.6 s / 6 s / 60 s / 6 min / 60 min

Main circuit	
Number of contacts	1 CO
Contact Material	AgNi
Rated voltage	250 V AC
Rated current	8 A
Minimum load	10 mA, 12 V
Inrush current	15 A, 20 ms
Rated load DC	fig. 2
Rated load AC-1	2000 VA
Mechanical endurance (cycles)	3 x 10 ⁷
Electrical endurance at rated load AC-1 (cycles)	fig. 3

Control circuit				
Nominal voltage	12 V UC	24 V UC	115 V AC	230 V AC
Operating voltage range	0.8 ... 1.2 U _N	0.8 ... 1.2 U _N	0.8 ... 1.2 U _N	0.8 ... 1.2 U _N
Power consumption AC / DC	50 / 32 mA	21 / 12 mA	47 mA / -	60 mA / -
Typ. input current on command input AC / DC	2.7 / 4.3 mA	11.6 / 9.5 mA	1.7 mA / -	1.9 mA / -
Typ. threshold voltage on command input AC / DC	5.2 / 8.8 V	9.5 / 14 V	42 V / -	80 V / -
Rated frequency	48 ... 62 Hz	48 ... 62 Hz	48 ... 62 Hz	48 ... 62 Hz

Insulation	
Rated test voltage control / main circuit	2 kV rms / 1 min
Rated test voltage open contact	1 kV rms / 1 min
Pollution degree	2
Overvoltage category	III

General data	
Ambient temperature storage	-40 ... 85 °C
Ambient temperature operation	-40 ... 60 °C
Conductor cross section	2.5 mm ² , 2 x 1.5 mm ²
Nominal screw torque	0.5 Nm
Module width	fig. 4
Weight	48 g
Protection degree	IP 20
Housing material	PA 66

Product references					
Types	Product reference	12	24	115	230
UC supply	CMD11-A/UC...V	✓	✓		
AC supply	CMD11-A/AC...V			✓	✓

"..." list control circuit voltage to complete product references.
Other voltages on request. Please contact support@comatreleco.com.



fig. 1. Wiring diagram

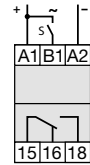


fig. 2. DC load limit curve

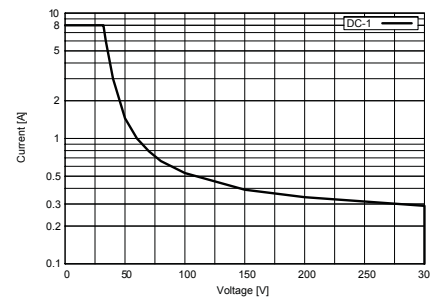


fig. 3. AC voltage endurance

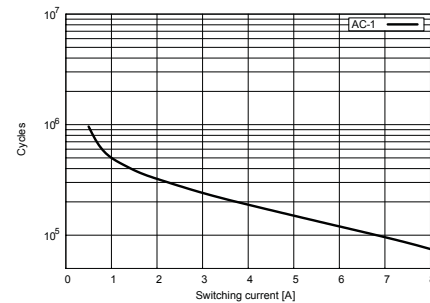
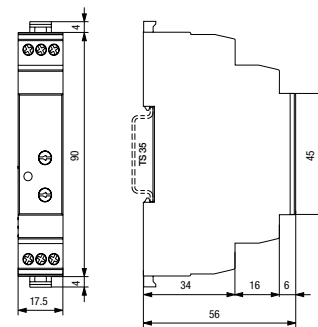


fig. 4. Dimensions (mm)



Standards and approvals

Standards IEC/EN 60947



CMD11-E

On delay | single voltage | 1 CO

Time data	
Timing functions	E
Timing range	50 ms ... 60 min
Timing scale	0.6 s / 6 s / 60 s / 6 min / 60 min

Main circuit	
Number of contacts	1 CO
Contact Material	AgNi
Rated voltage	250 V AC
Rated current	8 A
Minimum load	10 mA, 12 V
Inrush current	15 A, 20 ms
Rated load DC	fig. 2
Rated load AC-1	2000 VA
Mechanical endurance (cycles)	3 x 10 ⁷
Electrical endurance at rated load AC-1 (cycles)	fig. 3

Control circuit				
Nominal voltage	12 V UC	24 V UC	115 V AC	230 V AC
Operating voltage range	0.8 ... 1.2 U _N	0.8 ... 1.2 U _N	0.8 ... 1.2 U _N	0.8 ... 1.2 U _N
Power consumption AC / DC	50 / 32 mA	21 / 12 mA	47 mA / -	60 mA / -
Typ. input current on command input AC / DC	2.7 / 4.3 mA	11.6 / 9.5 mA	1.7 mA / -	1.9 mA / -
Typ. threshold voltage on command input AC / DC	5.2 / 8.8 V	9.5 / 14 V	42 V / -	80 V / -
Rated frequency	48 ... 62 Hz	48 ... 62 Hz	48 ... 62 Hz	48 ... 62 Hz

Insulation	
Rated test voltage control / main circuit	2 kV rms / 1 min
Rated test voltage open contact	1 kV rms / 1 min
Pollution degree	2
Overvoltage category	III

General data	
Ambient temperature storage	-40 ... 85 °C
Ambient temperature operation	-40 ... 60 °C
Conductor cross section	2.5 mm ² , 2 x 1.5 mm ²
Nominal screw torque	0.5 Nm
Module width	fig. 4
Weight	48 g
Protection degree	IP 20
Housing material	PA 66

Product references					
Types	Product reference	12	24	115	230
UC supply	CMD11-E/UC...V	✓	✓		
AC supply	CMD11-E/AC...V			✓	✓

"..." list control circuit voltage to complete product references.
Other voltages on request. Please contact support@comatreleco.com.



fig. 1. Wiring diagram

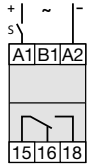


fig. 2. DC load limit curve

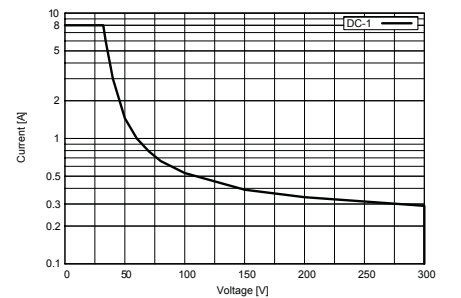


fig. 3. AC voltage endurance

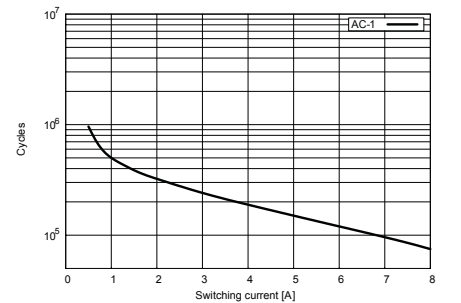
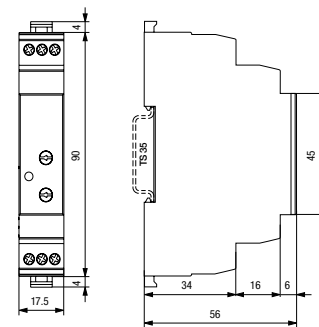


fig. 4. Dimensions (mm)



Standards and approvals

Standards IEC/EN 60947



AA2, AA2M

Off delay | 24 V UC | 220 ... 240 V AC | 1 CO

Time data	
Timing functions	A
Timing range	AA2: 0.8 s ... 1.5 min / AA2M: 0.1 min ... 12 min
Timing scale	AA2: 12 s / 1.5 min / AA2M: 1.5 min / 12 min

Main circuit	
Number of contacts	1 CO
Contact Material	AgNi
Rated voltage	250 V AC
Rated current	10 A
Minimum load	10 mA, 12 V
Inrush current	16 A, 10 ms
Rated load DC	fig. 2
Rated load AC-1	2500 VA
Mechanical endurance (cycles)	2 x 10 ⁷
Electrical endurance at rated load AC-1 (cycles)	fig. 3

Control circuit		
Nominal voltage	24 V UC	220 ... 240 V AC
Operating voltage range	0.8 ... 1.3 U _N	0.8 ... 1.1 U _N
Power consumption AC / DC	0.84 VA / 0.84 W	2.4 VA / -
Typ. input current on command input AC / DC	25 / 25 mA	5 mA / -
Typ. threshold voltage on command input AC / DC	10 / 10 V	176 V / -
Rated frequency	48 ... 63 Hz	48 ... 63 Hz

Insulation	
Rated test voltage control / main circuit	2 kV rms / 1 min
Rated test voltage open contact	1 kV rms / 1 min
Pollution degree	2
Overtoltage category	III

General data	
Ambient temperature storage	-40 ... 85 °C
Ambient temperature operation	-40 ... 60 °C
Conductor cross section	2.5 mm ² , 2 x 1.5 mm ²
Nominal screw torque	0.4 Nm
Module width	fig. 4
Weight	65 g
Protection degree	IP 20
Housing material	PC

Product references			
Types	Product reference	24	220-240
UC supply	AA2/UC...V	✓	
AC supply	AA2/AC...V		✓
UC supply	AA2M/UC...V	✓	
AC supply	AA2M/AC...V		✓

"..." list control circuit voltage to complete product references.
Other voltages on request. Please contact support@comatreleco.com.



fig. 1. Wiring diagram

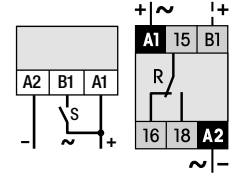


fig. 2. DC load limit curve

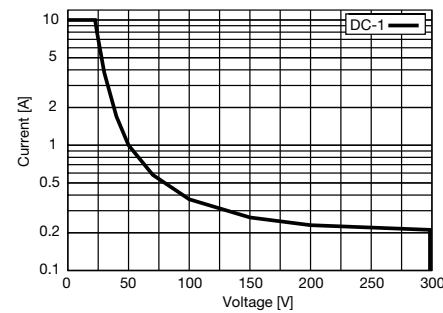


fig. 3. AC voltage endurance

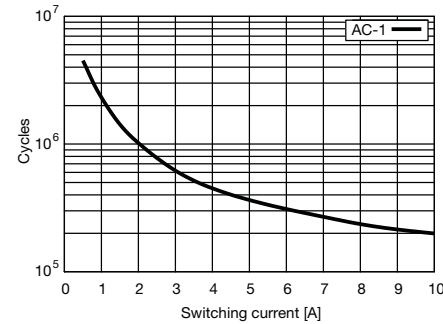
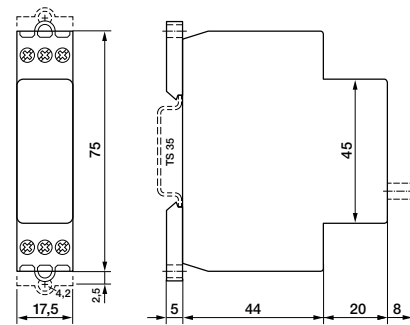


fig. 4. Dimensions (mm)



Standards and approvals

Standards IEC/EN 60947



AE2, AE2M

On delay | 24 V UC | 220 ... 240 V AC | 1 CO

Time data	
Timing functions	E
Timing range	AE2: 0.8 s ... 1.5 min / AE2M: 0.1 min ... 12 min
Timing scale	AE2: 12 s / 1.5 min / AE2M: 1.5 min / 12 min

Main circuit	
Number of contacts	1 CO
Contact Material	AgNi
Rated voltage	250 V AC
Rated current	10 A
Minimum load	10 mA, 12 V
Inrush current	16 A, 10 ms
Rated load DC	fig. 2
Rated load AC-1	2500 VA
Mechanical endurance (cycles)	2 x 10 ⁷
Electrical endurance at rated load AC-1 (cycles)	fig. 3

Control circuit		
Nominal voltage	24 V UC	220 ... 240 V AC
Operating voltage range	0.8 ... 1.3 U _N	0.8 ... 1.1 U _N
Power consumption AC / DC	0.84 VA / 0.84 W	2.4 VA / -
Typ. input current on command input AC / DC	25 / 25 mA	5 mA / -
Typ. threshold voltage on command input AC / DC	10 V / 10 V	176 V / -
Rated frequency	48 ... 63 Hz	48 ... 63 Hz

Insulation	
Rated test voltage control / main circuit	2 kV rms / 1 min
Rated test voltage open contact	1 kV rms / 1 min
Pollution degree	2
Overtoltage category	III

General data	
Ambient temperature storage	-40 ... 85 °C
Ambient temperature operation	-40 ... 60 °C
Conductor cross section	2.5 mm ² , 2 x 1.5 mm ²
Nominal screw torque	0.4 Nm
Module width	fig. 4
Weight	65 g
Protection degree	IP 20
Housing material	PC

Product references			
Types	Product reference	24	220-240
UC supply	AE2/UC...V	✓	
AC supply	AE2/AC...V		✓
UC supply	AE2M/UC...V	✓	
AC supply	AE2M/AC...V		✓

"..." list control circuit voltage to complete product references.
Other voltages on request. Please contact support@comatreleco.com.



fig. 1. Wiring diagram

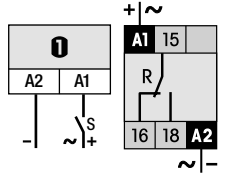


fig. 2. DC load limit curve

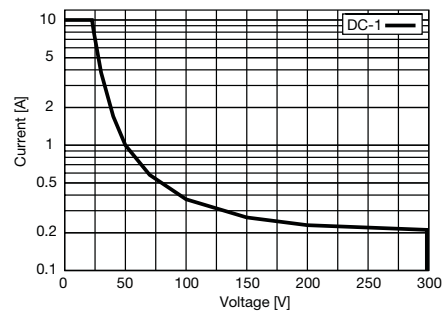


fig. 3. AC voltage endurance

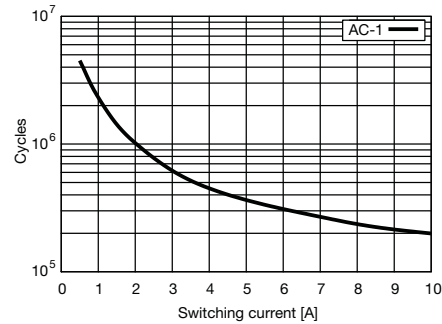
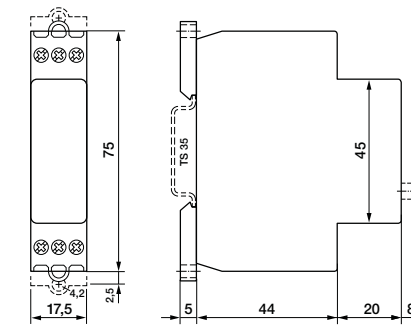


fig. 4. Dimensions (mm)

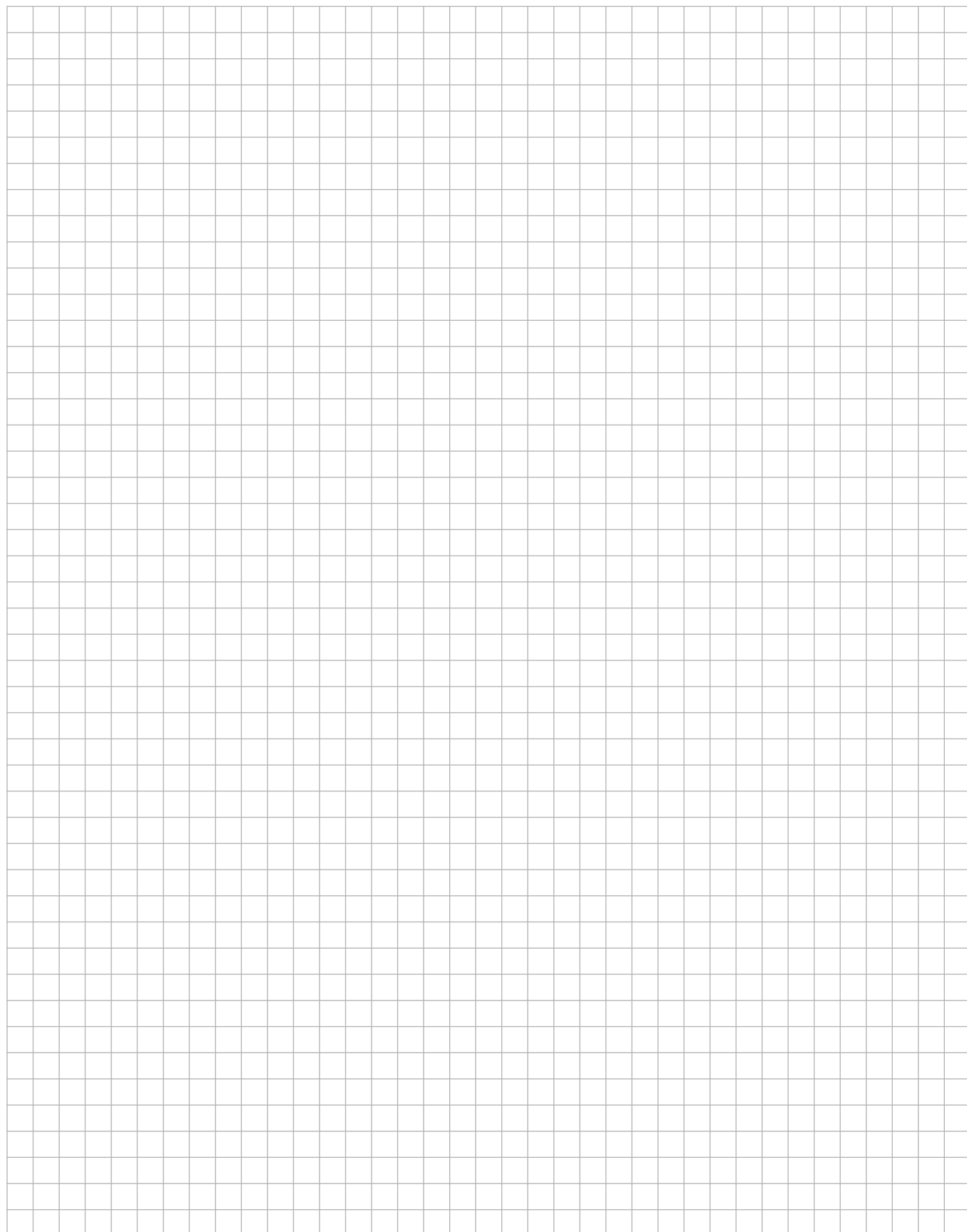


Standards and approvals

Standards IEC/EN 60947



Notes



2.2 Multifunction Time Relays

Application	Type	Page
CIM Series		
Multifunction 24 ... 240 V UC 1 CO	CIM1, CIM1R	160
Multifunction 24 ... 240 V UC 1 Triac	CIM12, CIM12R	161
Multifunction 24 ... 240 V UC 1 Mosfet	CIM13, CIM13R	162
Multifunction 24 ... 240 V UC 1 NO, pre-contact	CIM14	163
Multifunction 24 ... 240 V UC 1 CO	CIM2, CIM2R	164
Multifunction 24 ... 240 V UC 1 Triac	CIM22, CIM22R	165
Multifunction 24 ... 240 V UC 1 Mosfet	CIM23, CIM23R	166
Multifunction 24 ... 240 V UC 1 CO	CIM3, CIM3R	167
Multifunction 24 ... 240 V UC 1 Triac	CIM32, CIM32R	168
Multifunction 24 ... 240 V UC 1 Mosfet	CIM33, CIM33R	169
AL Series		
Staircase switch Auto - ON 220 ... 240 V AC 1 NO	AL1	170
Staircase switch Auto - ON 24 V UC 220 ... 240 V AC 1 NO, pre-contact	AL3	171
Staircase switch Auto - ON Central ON - OFF 220 ... 240 V AC 1 NO, pre-contact	AL4	172
Step switch Auto - ON Central ON - OFF 230 V AC 1 NO, pre-contact	AL5	173
AM Series		
Multifunction 24 ... 60 V UC 110 ... 240 V UC 1 CO	AM1	174
Multifunction 24 ... 60 V UC 220 ... 240 V AC 1 CO	AM2	175
Multifunction 24 ... 60 V UC 110 ... 240 V UC 2 CO	AM3	176

Notes

Application	Type	Page
CM Series		
Multifunction 24 ... 60 V UC 220 ... 240 V AC 1 NO + 1 CO	CM2	177
Multifunction 12 ... 24 V DC 24 ... 48 V DC, 24 ... 240 V AC 2 CO	CM3	178
CPF Series		
Pulse extension 24 V DC 1 PNP Transistor	CPF11	179
CRV Series		
Multifunction 24 ... 240 V UC 1 CO External potentiometer	CRV4	180
CSV Series		
Multifunction 12 ... 36 V DC 1 Mosfet External potentiometer	CSV4	181

CIM1, CIM1R

Multifunction | 24 ... 240 V UC | 1 CO

Time data	
Timing functions	fig. 1 1: E 2: A, K, N, B1, S, LS 3: B, W
Timing range	50 ms ... 60 h
Timing scale	0.6 s / 6 s / 60 s / 6 min / 60 min / 6 h / 60 h

Main circuit	
Number of contacts	1 CO
Contact Material	AgNi
Rated voltage	250 V AC
Rated current	16 A
Minimum load	10 mA, 10 V
Inrush current	30 A, 10 ms
Rated load DC	fig. 2
Rated load AC-1	4000 VA
Mechanical endurance (cycles)	3 x 10 ⁷
Electrical endurance at rated load AC-1 (cycles)	fig. 3

Control circuit	
Nominal voltage	24 ... 240 V UC
Operating voltage range	16.8 ... 250 V
Power consumption AC / DC	1.2 VA / 430 mW
Typ. input current on command input AC / DC	22 / 22 mA
Typ. threshold voltage on command input AC / DC	13 V / 15 V
Rated frequency	16 ... 63 Hz

Insulation	
Rated test voltage control / main circuit	2.5 kV rms / 1 min
Rated test voltage open contact	1 kV rms / 1 min
Pollution degree	2
Overvoltage category	III

General data	
Ambient temperature storage	-40 ... 85 °C
Ambient temperature operation	-40 ... 40 °C
Ambient temperature operation derated power	-40 ... 60 °C (I _N 13 A)
Ambient temperature operation railway version	-40 ... 70 °C
Conductor cross section	2.5 mm ² , 2 x 1.5 mm ²
Nominal screw torque	0.4 Nm
Module width	fig. 4
Weight	70 g
Protection degree	IP 20
Housing material	PC

Product references		
Types	Product reference	24-240
UC supply	CIM1/UC...V	✓
UC supply, Railway version	CIM1R/UC...V	✓

"..." list control circuit voltage to complete product references.
Other voltages on request. Please contact support@comatreleco.com.



fig. 1. Wiring diagram

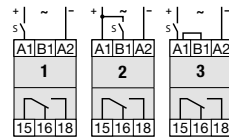


fig. 2. DC load limit curve

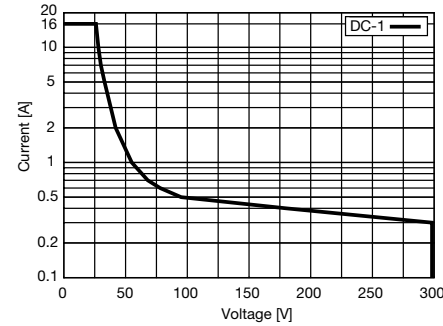


fig. 3. AC voltage endurance

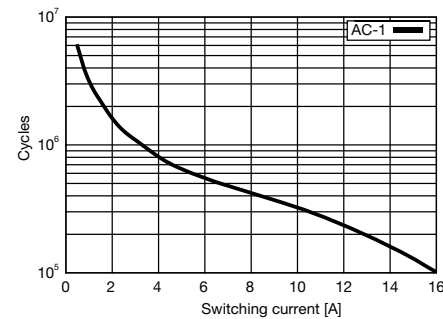
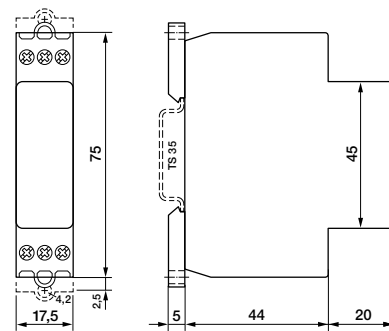


fig. 4. Dimensions (mm)



Standards and approvals

Standards IEC/EN 60947, IEC/EN 50155



CIM12, CIM12R

Multifunction | 24 ... 240 V UC | 1 Triac

Time data	
Timing functions	fig. 1 1: E 2: A, K, N, B1, S, LS 3: B, W
Timing range	50 ms ... 60 h
Timing scale	0.6 s / 6 s / 60 s / 6 min / 60 min / 6 h / 60 h

Main circuit	
Number of outputs	1 NO
Output type	Triac, zero crossing
Rated voltage	250 V AC
Rated current	2 A
Minimum load	50 mA, 12 V
Inrush current	100 A, 10 ms
Rated limit load	78 A ² s
Typ. leakage current	1 mA
Rated load AC-1	300 VA
Mechanical endurance (cycles)	∞
Electrical endurance at rated load AC-1 (cycles)	∞

Control circuit	
Nominal voltage	24 ... 240 V UC
Operating voltage range	16.8 ... 250 V
Power consumption AC / DC	1.2 VA / 430 mW
Typ. input current on command input AC / DC	22 / 22 mA
Typ. threshold voltage on command input AC / DC	13 V / 15 V
Rated frequency	16 ... 63 Hz

Insulation	
Rated test voltage control / main circuit	2.5 kV rms / 1 min
Rated test voltage open contact	0
Pollution degree	2
Overvoltage category	III

General data	
Ambient temperature storage	-40 ... 85 °C
Ambient temperature operation	-40 ... 40 °C
Ambient temperature operation derated power	-40 ... 60 °C (I _N 1.2 A)
Ambient temperature operation railway version	-40 ... 70 °C
Conductor cross section	2.5 mm ² , 2 x 1.5 mm ²
Nominal screw torque	0.4 Nm
Module width	fig. 2
Weight	70 g
Protection degree	IP 20
Housing material	PC

Product references		
Types	Product reference	24-240
UC supply	CIM12/UC...V	✓
UC supply, Railway version	CIM12R/UC...V	✓

"..." list control circuit voltage to complete product references.
Other voltages on request. Please contact support@comatreleco.com.



fig. 1. Wiring diagram

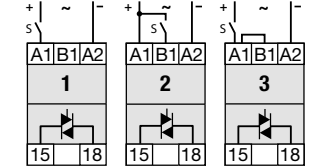
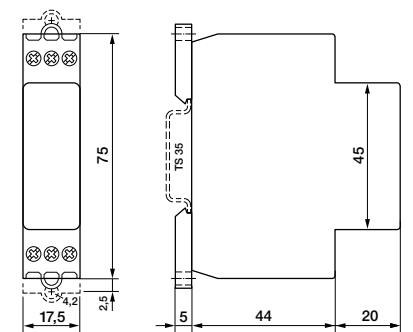


fig. 2. Dimensions (mm)



Standards and approvals

Standards IEC/EN 60947, IEC/EN 50155



CIM13, CIM13R

Multifunction | 24 ... 240 V UC | 1 Mosfet

Time data	
Timing functions	fig. 1 1: E 2: A, K, N, B1, S, LS 3: B, W
Timing range	50 ms ... 60 h
Timing scale	0.6 s / 6 s / 60 s / 6 min / 60 min / 6 h / 60 h

Main circuit	
Number of outputs	1 NO
Output type	Mosfet
Rated voltage	24 V DC
Rated current	5 A
Minimum load	1 mA, 1 V
Inrush current	40 A, 10 us
Typ. leakage current	10 µA
Mechanical endurance (cycles)	∞
Electrical endurance at rated load DC-1 (cycles)	∞

Control circuit	
Nominal voltage	24 ... 240 V UC
Operating voltage range	16.8 ... 250 V
Power consumption AC / DC	1.2 VA / 430 mW
Typ. input current on command input AC / DC	22 / 22 mA
Typ. threshold voltage on command input AC / DC	13 V / 15 V
Rated frequency	16 ... 63 Hz

Insulation	
Rated test voltage control / main circuit	2.5 kV rms / 1 min
Rated test voltage open contact	0
Pollution degree	2
Overtension category	III

General data	
Ambient temperature storage	-40 ... 85 °C
Ambient temperature operation	-40 ... 40 °C
Ambient temperature operation derated power	-40 ... 60 °C (I _N 4 A)
Ambient temperature operation railway version	-40 ... 70 °C
Conductor cross section	2.5 mm ² , 2 x 1.5 mm ²
Nominal screw torque	0.4 Nm
Module width	fig. 2
Weight	70 g
Protection degree	IP 20
Housing material	PC

Product references		
Types	Product reference	24-240
UC supply	CIM13/UC...V	✓
UC supply, Railway version	CIM13R/UC...V	✓

"..." list control circuit voltage to complete product references.
Other voltages on request. Please contact support@comatreleco.com.



fig. 1. Wiring diagram

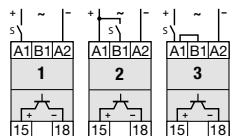
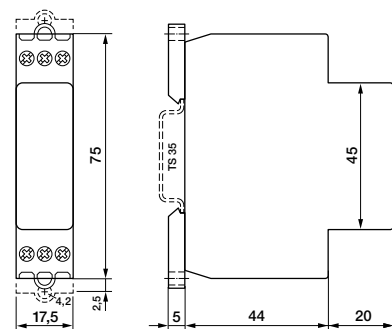


fig. 2. Dimensions (mm)



Standards and approvals

Standards IEC/EN 60947, IEC/EN 50155



CIM14

Multifunction | 24 ... 240 V UC | 1 NO, pre-contact

Time data	
Timing functions	fig. 1 1: E 2: A, K, N, B1, S, LS 3: B, W
Timing range	50 ms ... 60 h
Timing scale	0.6 s / 6 s / 60 s / 6 min / 60 min / 6 h / 60 h

Main circuit	
Number of contacts	1 NO
Contact Material	W + AgSnO ₂
Rated voltage	250 V AC
Rated current	16 A
Minimum load	100 mA, 12 V
Inrush current	800 A, 200 us / 165 A, 20 ms
Rated load DC	fig. 2
Rated load AC-1	4000 VA
Mechanical endurance (cycles)	5 x 10 ⁶
Electrical endurance at rated load AC-1 (cycles)	fig. 3

Control circuit	
Nominal voltage	24 ... 240 V UC
Operating voltage range	16.8 ... 250 V
Power consumption AC / DC	1.2 VA / 430 mW
Typ. input current on command input AC / DC	22 / 22 mA
Typ. threshold voltage on command input AC / DC	13 V / 15 V
Rated frequency	16 ... 63 Hz

Insulation	
Rated test voltage control / main circuit	2.5 kV rms / 1 min
Rated test voltage open contact	1 kV rms / 1 min
Pollution degree	2
Overtension category	III

General data	
Ambient temperature storage	-40 ... 85 °C
Ambient temperature operation	-40 ... 40 °C
Ambient temperature operation derated power	-40 ... 60 °C (I _N 13 A)
Conductor cross section	2.5 mm ² , 2 x 1.5 mm ²
Nominal screw torque	0.4 Nm
Module width	fig. 4
Weight	70 g
Protection degree	IP 20
Housing material	PC

Product references		
Types	Product reference	24-240
UC supply	CIM14/UC...V	✓

"..." list control circuit voltage to complete product references.
Other voltages on request. Please contact support@comatreleco.com.



fig. 1. Wiring diagram

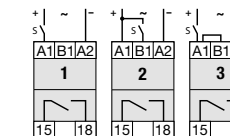


fig. 2. DC load limit curve

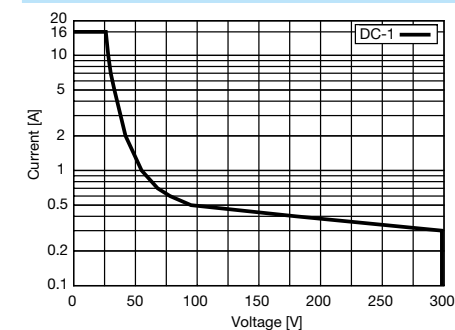


fig. 3. AC voltage endurance

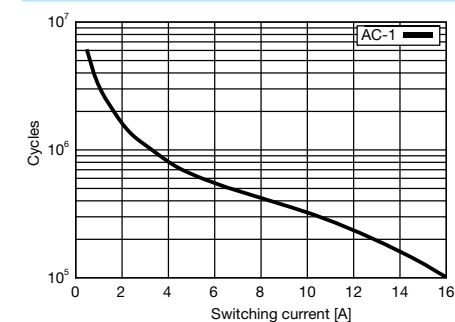
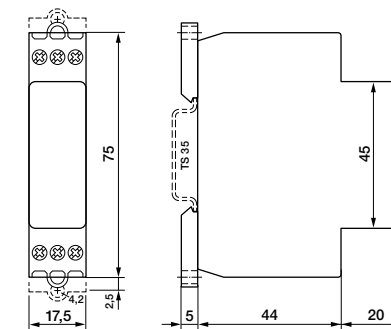


fig. 4. Dimensions (mm)



Standards and approvals

Standards IEC/EN 60947, IEC/EN 50155



CIM2, CIM2R

Multifunction | 24 ... 240 V UC | 1 CO

Time data	
Timing functions	fig. 1 1: E 2: A, L, M, G 3: B2, H
Timing range	50 ms ... 60 h
Timing scale	0.6 s / 6 s / 60 s / 6 min / 60 min / 6 h / 60 h

Main circuit	
Number of contacts	1 CO
Contact Material	AgNi
Rated voltage	250 V AC
Rated current	16 A
Minimum load	10 mA, 10 V
Inrush current	30 A, 10 ms
Rated load DC	fig. 2
Rated load AC-1	4000 VA
Mechanical endurance (cycles)	3 x 10 ⁷
Electrical endurance at rated load AC-1 (cycles)	fig. 3

Control circuit	
Nominal voltage	24 ... 240 V UC
Operating voltage range	16.8 ... 250 V
Power consumption AC / DC	1.2 VA / 430 mW
Typ. input current on command input AC / DC	22 / 22 mA
Typ. threshold voltage on command input AC / DC	13 V / 15 V
Rated frequency	16 ... 63 Hz

Insulation	
Rated test voltage control / main circuit	2.5 kV rms / 1 min
Rated test voltage open contact	1 kV rms / 1 min
Pollution degree	2
Oversvoltage category	III

General data	
Ambient temperature storage	-40 ... 85 °C
Ambient temperature operation	-40 ... 40 °C
Ambient temperature operation derated power	-40 ... 60 °C (I _N 13 A)
Ambient temperature operation railway version	-40 ... 70 °C
Conductor cross section	2.5 mm ² , 2 x 1.5 mm ²
Nominal screw torque	0.4 Nm
Module width	fig. 4
Weight	70 g
Protection degree	IP 20
Housing material	PC

Product references		
Types	Product reference	24-240
UC supply	CIM2/UC...V	✓
UC supply, Railway version	CIM2R/UC...V	✓

"..." list control circuit voltage to complete product references.
Other voltages on request. Please contact support@comatreleco.com.

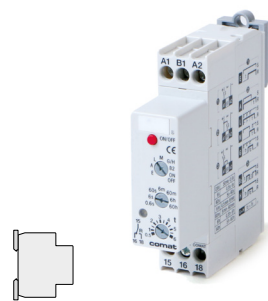


fig. 1. Wiring diagram

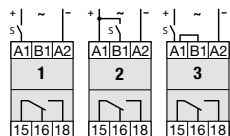


fig. 2. DC load limit curve

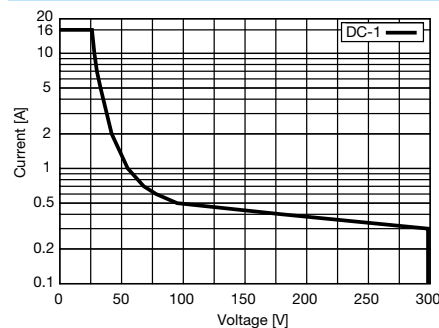


fig. 3. AC voltage endurance

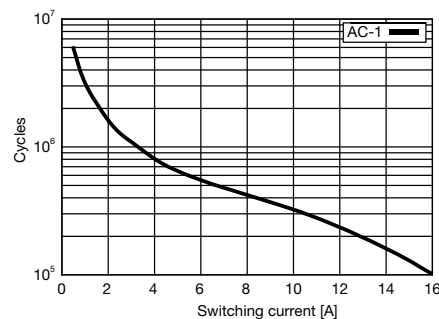
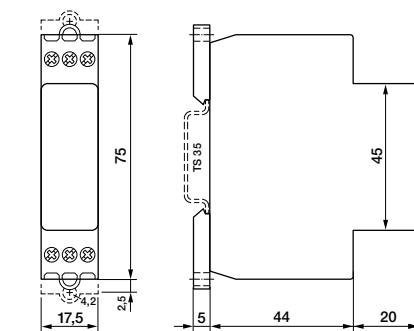


fig. 4. Dimensions (mm)



Standards and approvals

Standards IEC/EN 60947, IEC/EN 50155



CIM22, CIM22R

Multifunction | 24 ... 240 V UC | 1 Triac

Time data	
Timing functions	fig. 1 1: E 2: A, L, M, G 3: B2, H
Timing range	50 ms ... 60 h
Timing scale	0.6 s / 6 s / 60 s / 6 min / 60 min / 6 h / 60 h

Main circuit	
Number of outputs	1 NO
Output type	Triac, zero crossing
Rated voltage	250 V AC
Rated current	2 A
Minimum load	50 mA, 12 V
Inrush current	100 A, 10 ms
Rated limit load	78 A ² s
Typ. leakage current	1 mA
Rated load AC-1	300 VA
Mechanical endurance (cycles)	∞
Electrical endurance at rated load AC-1 (cycles)	∞

Control circuit	
Nominal voltage	24 ... 240 V UC
Operating voltage range	16.8 ... 250 V
Power consumption AC / DC	1.2 VA / 430 mW
Typ. input current on command input AC / DC	22 / 22 mA
Typ. threshold voltage on command input AC / DC	13 V / 15 V
Rated frequency	16 ... 63 Hz

Insulation	
Rated test voltage control / main circuit	2.5 kV rms / 1 min
Rated test voltage open contact	0
Pollution degree	2
Oversvoltage category	III

General data	
Ambient temperature storage	-40 ... 85 °C
Ambient temperature operation	-40 ... 40 °C
Ambient temperature operation derated power	-40 ... 60 °C (I _N 1.2 A)
Ambient temperature operation railway version	-40 ... 70 °C
Conductor cross section	2.5 mm ² , 2 x 1.5 mm ²
Nominal screw torque	0.4 Nm
Module width	fig. 2
Weight	70 g
Protection degree	IP 20
Housing material	PC

Product references		
Types	Product reference	24-240
UC supply	CIM22/UC...V	✓
UC supply, Railway version	CIM22R/UC...V	✓

"..." list control circuit voltage to complete product references.
Other voltages on request. Please contact support@comatreleco.com.

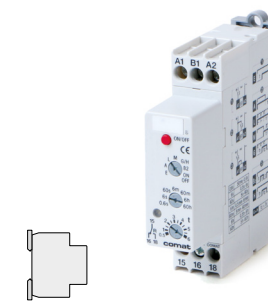


fig. 1. Wiring diagram

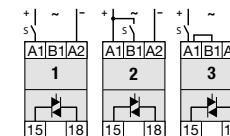
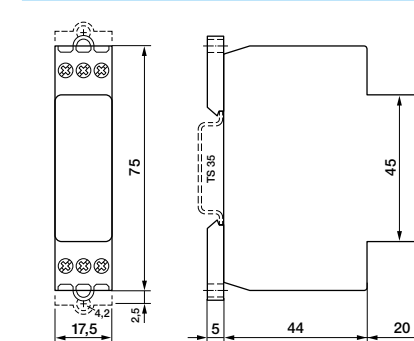


fig. 2. Dimensions (mm)



Standards and approvals

Standards IEC/EN 60947, IEC/EN 50155



CIM23, CIM23R

Multifunction | 24 ... 240 V UC | 1 Mosfet

Time data

Timing functions	fig. 1 1: E 2: A, L, M, G 3: B2, H
Timing range	50 ms ... 60 h
Timing scale	0.6 s / 6 s / 60 s / 6 min / 60 min / 6 h / 60 h

Main circuit

Number of outputs	1 NO
Output type	Mosfet
Rated voltage	24 V DC
Rated current	5 A
Minimum load	1 mA, 1 V
Inrush current	40 A, 10 us
Typ. leakage current	10 µA
Mechanical endurance (cycles)	∞
Electrical endurance at rated load DC-1 (cycles)	∞

Control circuit

Nominal voltage	24 ... 240 V UC
Operating voltage range	16.8 ... 250 V
Power consumption AC / DC	1.2 VA / 430 mW
Typ. input current on command input AC / DC	22 / 22 mA
Typ. threshold voltage on command input AC / DC	13 V / 15 V
Rated frequency	16 ... 63 Hz

Insulation

Rated test voltage control / main circuit	2.5 kV rms / 1 min
Rated test voltage open contact	0
Pollution degree	2
Overvoltage category	III

General data

Ambient temperature storage	-40 ... 85 °C
Ambient temperature operation	-40 ... 40 °C
Ambient temperature operation derated power	-40 ... 60 °C (I _N 4 A)
Ambient temperature operation railway version	-40 ... 70 °C
Conductor cross section	2.5 mm ² , 2 x 1.5 mm ²
Nominal screw torque	0.4 Nm
Module width	fig. 2
Weight	70 g
Protection degree	IP 20
Housing material	PC

Product references

Types	Product reference	24-240
UC supply	CIM23/UC...V	✓
UC supply, Railway version	CIM23R/UC...V	✓

"..." list control circuit voltage to complete product references.
Other voltages on request. Please contact support@comatreleco.com.



fig. 1. Wiring diagram

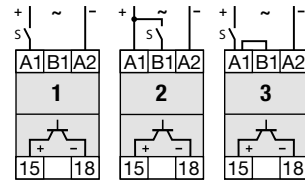
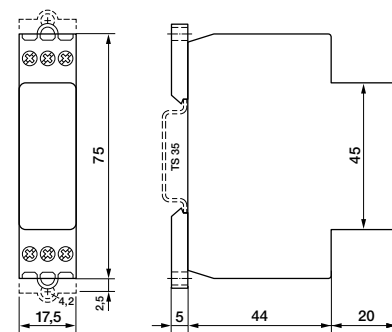


fig. 2. Dimensions (mm)



Standards and approvals

Standards IEC/EN 60947, IEC/EN 50155



CIM3, CIM3R

Multifunction | 24 ... 240 V UC | 1 CO

Time data

Timing functions	fig. 1 2: F, Q, G 3: I, P, H
Timing range	50 ms ... 60 h
Timing scale	0.6 s / 6 s / 60 s / 6 min / 60 min / 6 h / 60 h

Main circuit

Number of contacts	1 CO
Contact Material	AgNi
Rated voltage	250 V AC
Rated current	16 A
Minimum load	10 mA, 10 V
Inrush current	30 A, 10 ms
Rated load DC	fig. 2
Rated load AC-1	4000 VA
Mechanical endurance (cycles)	3 x 10 ⁷
Electrical endurance at rated load AC-1 (cycles)	fig. 3

Control circuit

Nominal voltage	24 ... 240 V UC
Operating voltage range	16.8 ... 250 V
Power consumption AC / DC	1.2 VA / 430 mW
Typ. input current on command input AC / DC	22 / 22 mA
Typ. threshold voltage on command input AC / DC	13 V / 15 V
Rated frequency	16 ... 63 Hz

Insulation

Rated test voltage control / main circuit	2.5 kV rms / 1 min
Rated test voltage open contact	0
Pollution degree	2
Overvoltage category	III

General data

Ambient temperature storage	-40 ... 85 °C
Ambient temperature operation	-40 ... 40 °C
Ambient temperature operation derated power	-40 ... 60 °C (I _N 13 A)
Ambient temperature operation railway version	-40 ... 70 °C
Conductor cross section	2.5 mm ² , 2 x 1.5 mm ²
Nominal screw torque	0.4 Nm
Module width	fig. 4
Weight	70 g
Protection degree	IP 20
Housing material	PC

Product references

Types	Product reference	24-240
UC supply	CIM3/UC...V	✓
UC supply, Railway version	CIM3R/UC...V	✓

"..." list control circuit voltage to complete product references.
Other voltages on request. Please contact support@comatreleco.com.



fig. 1. Wiring diagram

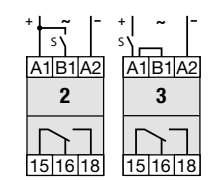


fig. 2. DC load limit curve

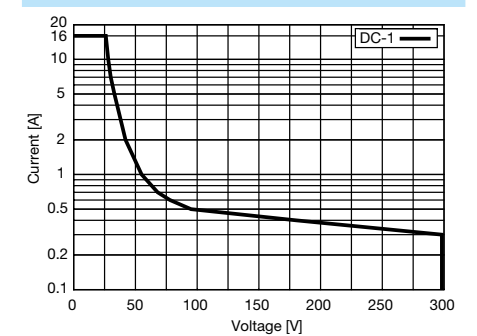


fig. 3. AC voltage endurance

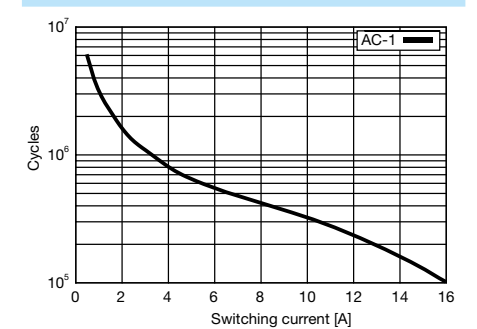
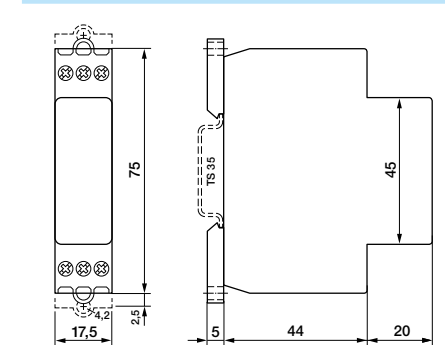


fig. 4. Dimensions (mm)



Standards and approvals

Standards IEC/EN 60947, IEC/EN 50155



CIM32, CIM32R

Multifunction | 24 ... 240 V UC | 1 Triac

Time data	
Timing functions	fig. 1 2: F, Q, G 3: I, P, H
Timing range	50 ms ... 60 h
Timing scale	0.6 s / 6 s / 60 s / 6 min / 60 min / 6 h / 60 h

Main circuit	
Number of outputs	1 NO
Output type	⚡ Triac, zero crossing
Rated voltage	250 V AC
Rated current	2 A
Minimum load	50 mA, 12 V
Inrush current	100 A, 10 ms
Rated limit load	78 A ² s
Typ. leakage current	1 mA
Rated load AC-1	300 VA
Mechanical endurance (cycles)	∞
Electrical endurance at rated load AC-1 (cycles)	∞

Control circuit	
Nominal voltage	24 ... 240 V UC
Operating voltage range	16.8 ... 250 V
Power consumption AC / DC	1.2 VA / 430 mW
Typ. input current on command input AC / DC	22 / 22 mA
Typ. threshold voltage on command input AC / DC	13 V / 15 V
Rated frequency	16 ... 63 Hz

Insulation	
Rated test voltage control / main circuit	2.5 kV rms / 1 min
Rated test voltage open contact	0
Pollution degree	2
Overvoltage category	III

General data	
Ambient temperature storage	-40 ... 85 °C
Ambient temperature operation	-40 ... 40 °C
Ambient temperature operation derated power	-40 ... 60 °C (I _N 1.2 A)
Ambient temperature operation railway version	-40 ... 70 °C
Conductor cross section	2.5 mm ² , 2 x 1.5 mm ²
Nominal screw torque	0.4 Nm
Module width	fig. 2
Weight	70 g
Protection degree	IP 20
Housing material	PC

Product references		
Types	Product reference	24-240
UC supply	CIM32/UC...V	✓
UC supply, Railway version	CIM32R/UC...V	✓

"..." list control circuit voltage to complete product references.
Other voltages on request. Please contact support@comatreleco.com.

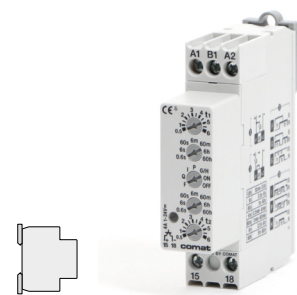


fig. 1. Wiring diagram

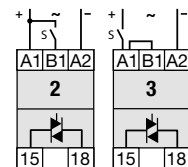
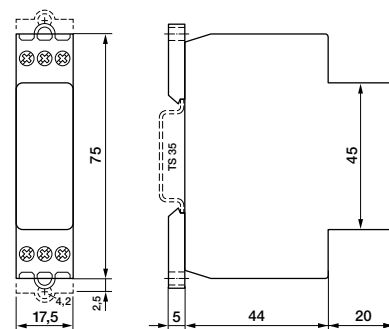


fig. 2. Dimensions (mm)



Standards and approvals

Standards IEC/EN 60947



CIM33, CIM33R

Multifunction | 24 ... 240 V UC | 1 Mosfet

Time data	
Timing functions	fig. 1 2: F, Q, G 3: I, P, H
Timing range	50 ms ... 60 h
Timing scale	0.6 s / 6 s / 60 s / 6 min / 60 min / 6 h / 60 h

Main circuit	
Number of outputs	1 NO
Output type	⚡ Mosfet
Rated voltage	24 V DC
Rated current	5 A
Minimum load	1 mA, 1 V
Inrush current	40 A, 10 us
Typ. leakage current	10 μA
Mechanical endurance (cycles)	∞
Electrical endurance at rated load DC-1 (cycles)	∞

Control circuit	
Nominal voltage	24 ... 240 V UC
Operating voltage range	16.8 ... 250 V
Power consumption AC / DC	1.2 VA / 430 mW
Typ. input current on command input AC / DC	22 / 22 mA
Typ. threshold voltage on command input AC / DC	13 V / 15 V
Rated frequency	16 ... 63 Hz

Insulation	
Rated test voltage control / main circuit	2.5 kV rms / 1 min
Rated test voltage open contact	0
Pollution degree	2
Overvoltage category	III

General data	
Ambient temperature storage	-40 ... 85 °C
Ambient temperature operation	-40 ... 40 °C
Ambient temperature operation derated power	-40 ... 60 °C (I _N 4 A)
Ambient temperature operation railway version	-40 ... 70 °C
Conductor cross section	2.5 mm ² , 2 x 1.5 mm ²
Nominal screw torque	0.4 Nm
Module width	fig. 2
Weight	70 g
Protection degree	IP 20
Housing material	PC

Product references		
Types	Product reference	24-240
UC supply	CIM33/UC...V	✓
UC supply, Railway version	CIM33R/UC...V	✓

"..." list control circuit voltage to complete product references.
Other voltages on request. Please contact support@comatreleco.com.

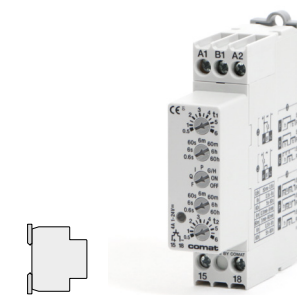


fig. 1. Wiring diagram

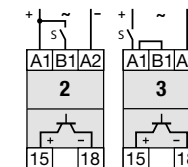
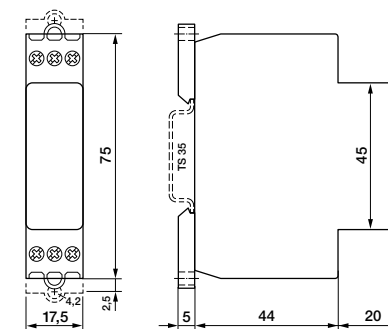


fig. 2. Dimensions (mm)



Standards and approvals

Standards IEC/EN 60947



AL1

Staircase switch | Auto - ON | 220 ... 240 V AC | 1 NO

Time data	
Timing functions	L
Timing range	30 s ... 10 min

Main circuit	
Number of contacts	1 NO
Contact Material	AgNi
Rated voltage	250 V
Rated current	10 A
Minimum load	10 mA, 12 V
Inrush current	16 A, 10 ms
Rated load DC	fig. 2
Rated load AC-1	2500 VA
Mechanical endurance (cycles)	2×10^7
Electrical endurance at rated load AC-1 (cycles)	fig. 3

Control circuit	
Nominal voltage	220 ... 240 V AC
Operating voltage range	187 ... 265 V
Power consumption AC / DC	2.5 VA
Typ. input current on command input AC / DC	45 mA / -
Typ. threshold voltage on command input AC / DC	$0.7 U_N$
Rated frequency	48 ... 62 Hz

Insulation	
Rated test voltage control / main circuit	2.5 kV rms / 1 min
Rated test voltage open contact	2.5 kV rms / 1 min
Pollution degree	2
Overtoltage category	III

General data	
Ambient temperature storage	-40 ... 85 °C
Ambient temperature operation	-40 ... 40 °C
Conductor cross section	2.5 mm ² , 2 x 1.5 mm ²
Nominal screw torque	0.4 Nm
Module width	fig. 4
Weight	71 g
Protection degree	IP 20
Housing material	PC

Product references

Types	Product reference	220-240
AC supply	AL1/AC...V	✓

"..." list control circuit voltage to complete product references.
Other voltages on request. Please contact support@comatreleco.com.



fig. 1. Wiring diagram

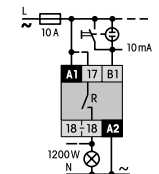


fig. 2. DC load limit curve

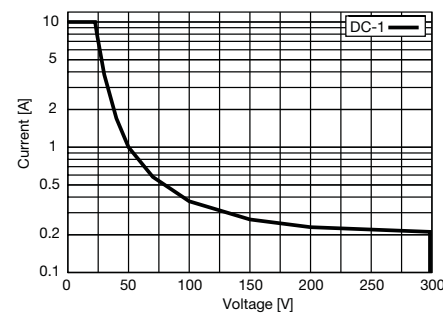


fig. 3. AC voltage endurance

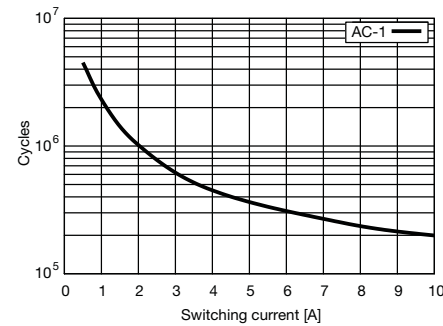
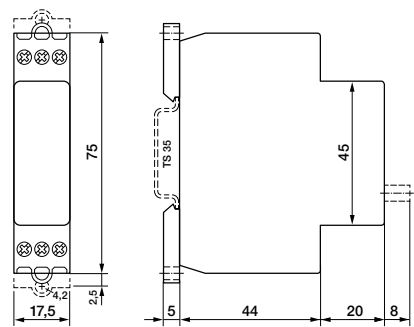


fig. 4. Dimensions (mm)



Standards and approvals

Standards IEC/EN 60947

Approvals

AL3

Staircase switch | Auto - ON | 24 V UC | 220 ... 240 V AC | 1 NO, pre-contact

Time data	
Timing functions	L, LS, S
Timing range	30 s - 60 min
Timing scale	6 min / 60 min

Main circuit	
Number of contacts	1 NO
Contact Material	W + AgSnO ₂
Rated voltage	250 V
Rated current	10 A
Minimum load	10 mA, 12 V
Inrush current	600 A, 2.5 ms / 120 A, 20 ms
Rated load DC	210 W, 30 V
Rated load AC-1	2500 VA
Mechanical endurance (cycles)	5×10^6
Electrical endurance at rated load AC-1 (cycles)	5×10^3

Control circuit		
Nominal voltage	24 V UC	220 ... 240 V AC
Operating voltage range	19.2 ... 30 V	187 ... 265 V
Power consumption AC / DC	2.5 VA / 2.5 W	2.5 VA / 2.5 W
Typ. input current on command input AC / DC	500 mA	120 mA
Typ. threshold voltage on command input AC / DC	18 V	175 V
Rated frequency	48 ... 63 Hz	48 ... 63 Hz

Insulation	
Rated test voltage control / main circuit	2.5 kV rms / 1 min
Rated test voltage open contact	2.5 kV rms / 1 min
Pollution degree	2
Overtoltage category	III

General data	
Ambient temperature storage	-40 ... 85 °C
Ambient temperature operation	-25 ... 60 °C
Conductor cross section	2.5 mm ² , 2 x 1.5 mm ²
Nominal screw torque	0.4 Nm
Module width	fig. 4
Weight	98 g
Protection degree	IP 20
Housing material	PC

Product references

Types	Product reference	24	220-240
UC supply	AL3/UC...V	✓	
AC supply	AL3/AC...V		✓

"..." list control circuit voltage to complete product references.
Other voltages on request. Please contact support@comatreleco.com.



fig. 1. Wiring diagram

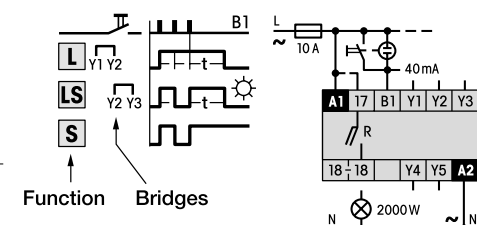
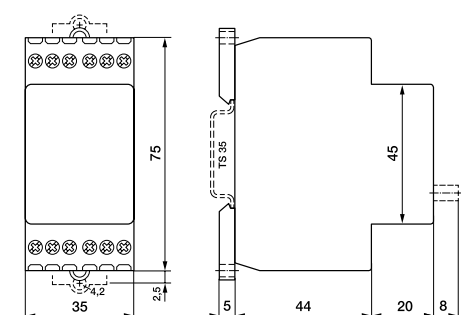


fig. 2. Dimensions (mm)



Standards and approvals

Standards IEC/EN 60947

Approvals

AL4

Staircase switch | Auto - ON | Central ON - OFF | 220 ... 240 V AC | 1 NO, pre-contact

Time data	
Timing functions	fig. 1 L, LS, S
Timing range	30 s - 60 min
Timing scale	6 min / 60 min

Main circuit	
Number of contacts	1 NO
Contact Material	W + AgSnO ₂
Rated voltage	250 V
Rated current	10 A
Minimum load	10 mA, 12 V
Inrush current	600 A, 2.5 ms / 120 A, 20 ms
Rated load DC	210 W, 30 V
Rated load AC-1	2500 VA
Mechanical endurance (cycles)	5 x 10 ⁶
Electrical endurance at rated load AC-1 (cycles)	5 x 10 ³

Control circuit	
Nominal voltage	220 ... 240 V AC
Operating voltage range	187 ... 265 V
Power consumption AC / DC	2.5 VA
Typ. input current on command input AC / DC	120 mA
Typ. threshold voltage on command input AC / DC	175 V
Rated frequency	48 ... 62 Hz

Insulation	
Rated test voltage control / main circuit	2.5 kV rms / 1 min
Rated test voltage open contact	2.5 kV rms / 1 min
Pollution degree	2
Overvoltage category	III

General data	
Ambient temperature storage	-40 ... 85 °C
Ambient temperature operation	-25 ... 60 °C
Conductor cross section	2.5 mm ² , 2 x 1.5 mm ²
Nominal screw torque	0.4 Nm
Module width	fig. 4
Weight	98 g
Protection degree	IP 20
Housing material	PC

Product references		
Types	Product reference	220-240
UC supply	AL4/UC...V	✓
AC supply	AL4/AC...V	

"..." list control circuit voltage to complete product references.
Other voltages on request. Please contact support@comatreleco.com.



fig. 1. Wiring diagram

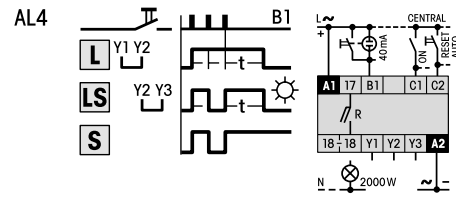
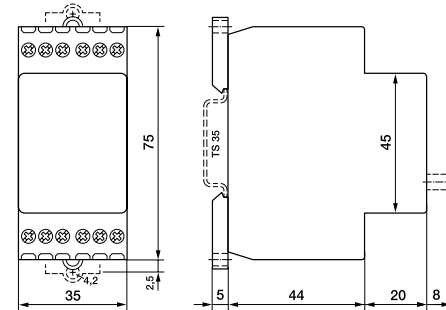


fig. 2. Dimensions (mm)



Standards and approvals

Standards IEC/EN 60947



AL5

Step switch | Auto - ON | Central ON - OFF | 230 V AC | 1 NO, pre-contact

Time data	
Timing functions	S

Main circuit	
Number of contacts	1 NO
Contact Material	W + AgSnO ₂
Rated voltage	250 V
Rated current	10 A
Minimum load	10 mA, 12 V
Inrush current	600 A, 2.5 ms / 120 A, 20 ms
Rated load DC	210 W, 30 V
Rated load AC-1	2500 VA
Mechanical endurance (cycles)	5 x 10 ⁶
Electrical endurance at rated load AC-1 (cycles)	5 x 10 ³

Control circuit	
Nominal voltage	230 V AC
Operating voltage range	187 ... 265 V
Power consumption AC / DC	2.5 VA
Typ. input current on command input AC / DC	120 mA
Typ. threshold voltage on command input AC / DC	165 V
Rated frequency	48 ... 62 Hz

Insulation	
Rated test voltage control / main circuit	2.5 kV rms / 1 min
Rated test voltage open contact	2.5 kV rms / 1 min
Pollution degree	2
Overvoltage category	III

General data	
Ambient temperature storage	-40 ... 85 °C
Ambient temperature operation	-25 ... 60 °C
Conductor cross section	2.5 mm ² , 2 x 1.5 mm ²
Nominal screw torque	0.4 Nm
Module width	fig. 4
Weight	98 g
Protection degree	IP 20
Housing material	PC

Product references		
Types	Product reference	230
AC supply	AL5/AC...V	✓

"..." list control circuit voltage to complete product references.
Other voltages on request. Please contact support@comatreleco.com.



fig. 1. Wiring diagram

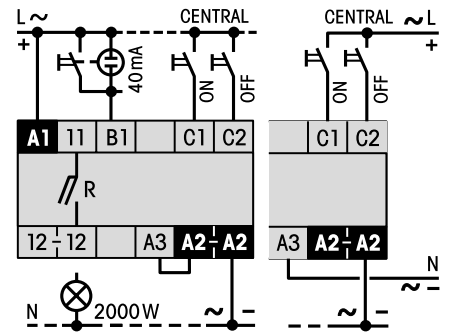
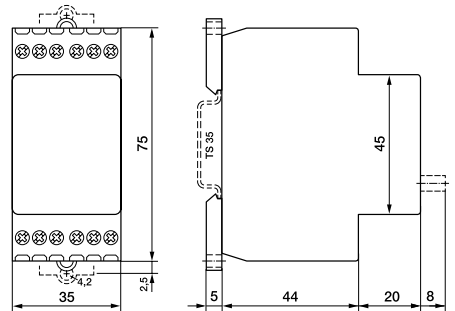


fig. 2. Dimensions (mm)



Standards and approvals

Standards IEC/EN 60947



AM1

Multifunction | 24 ... 60 V UC | 110 ... 240 V UC | 1 CO

Time data	
Timing functions	E, W, B, B2
Timing range	0.5 s ... 60 min
Timing scale	6 min / 60 min

Main circuit	
Number of contacts	1 CO
Contact Material	AgNi
Rated voltage	250 V
Rated current	10 A
Minimum load	10 mA, 12 V
Inrush current	16 A, 10 ms
Rated load DC	fig. 2
Rated load AC-1	2500 VA
Mechanical endurance (cycles)	2 x 10 ⁷
Electrical endurance at rated load AC-1 (cycles)	fig. 3

Control circuit		
Nominal voltage	24 ... 60 V UC	220 ... 240 V AC
Operating voltage range	20 - 75 V	180 - 265 V
Power consumption AC / DC	1.5 VA / 1.5 W	1.5 VA / 1.5 W
Typ. input current on command input AC / DC	40 / 40 mA	15 / 15 mA
Typ. threshold voltage on command input AC / DC	18 V / 18 V	170 V / 170 V
Rated frequency	40 ... 60 Hz	40 ... 60 Hz

Insulation	
Rated test voltage control / main circuit	2 kV rms / 1 min
Rated test voltage open contact	1 kV rms / 1 min
Pollution degree	2
Overtoltage category	III

General data	
Ambient temperature storage	-40 ... 85 °C
Ambient temperature operation	-40 ... 60 °C
Conductor cross section	2.5 mm ² , 2 x 1.5 mm ²
Nominal screw torque	0.4 Nm
Module width	fig. 4
Weight	70 g
Protection degree	IP 20
Housing material	PC

Product references		
Types	Product reference	24-60 220-240
UC supply	AM1/UC...V	✓ ✓

"..." list control circuit voltage to complete product references.
Other voltages on request. Please contact support@comatreleco.com.

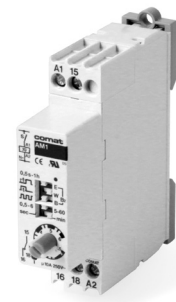


fig. 1. Wiring diagram

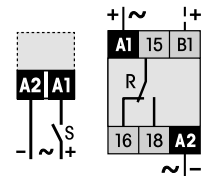


fig. 2. DC load limit curve

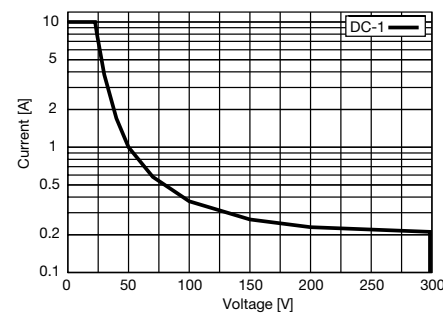


fig. 3. AC voltage endurance

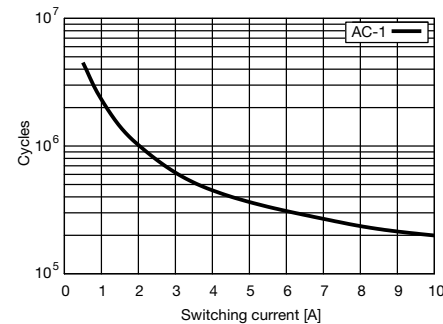
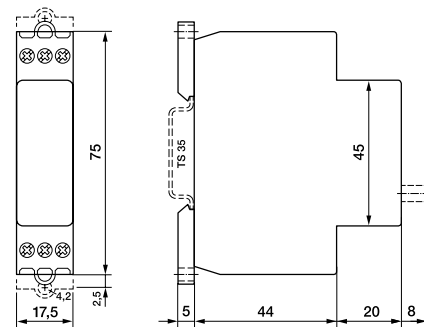


fig. 4. Dimensions (mm)



Standards and approvals

Standards IEC/EN 60947



AM2

Multifunction | 24 ... 60 V UC | 220 ... 240 V AC | 1 CO

Time data	
Timing functions	fig. 1 1: E 2: A, K 3: W
Timing range	0.5 s ... 60 min
Timing scale	6 min / 60 min

Main circuit	
Number of contacts	1 CO
Contact Material	AgNi
Rated voltage	250 V
Rated current	10 A
Minimum load	10 mA, 12 V
Inrush current	16 A, 10 ms
Rated load DC	fig. 2
Rated load AC-1	2500 VA
Mechanical endurance (cycles)	2 x 10 ⁷
Electrical endurance at rated load AC-1 (cycles)	fig. 3

Control circuit		
Nominal voltage	24 ... 60 V UC	220 ... 240 V AC
Operating voltage range	20 - 75 V	180 - 265 V
Power consumption AC / DC	1.5 VA / 1.5 W	1.5 VA / 1.5 W
Typ. input current on command input AC / DC	40 / 40 mA	15 / 15 mA
Typ. threshold voltage on command input AC / DC	18 V / 18 V	170 V / 170 V
Rated frequency	40 ... 60 Hz	40 ... 60 Hz

Insulation	
Rated test voltage control / main circuit	2 kV rms / 1 min
Rated test voltage open contact	1 kV rms / 1 min
Pollution degree	2
Overtoltage category	III

General data	
Ambient temperature storage	-40 ... 85 °C
Ambient temperature operation	-40 ... 60 °C
Conductor cross section	2.5 mm ² , 2 x 1.5 mm ²
Nominal screw torque	0.4 Nm
Module width	fig. 4
Weight	70 g
Protection degree	IP 20
Housing material	PC

Product references		
Types	Product reference	24-60 220-240
UC supply	AM2/UC...V	✓
AC supply	AM2/AC...V	✓

"..." list control circuit voltage to complete product references.
Other voltages on request. Please contact support@comatreleco.com.

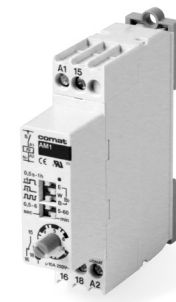


fig. 1. Wiring diagram

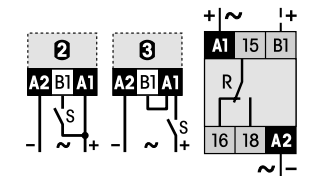


fig. 2. DC load limit curve

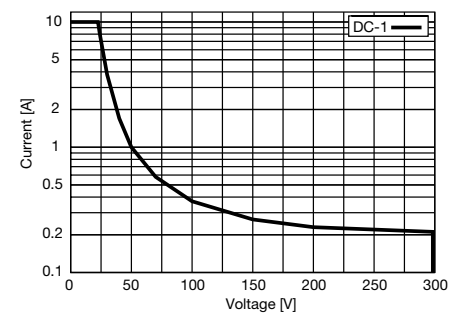


fig. 3. AC voltage endurance

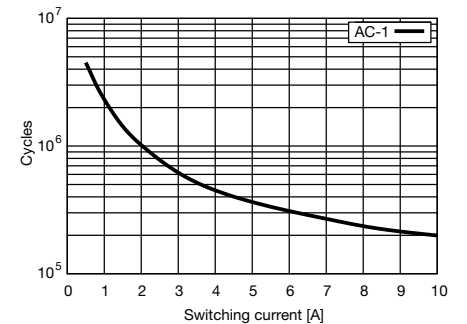
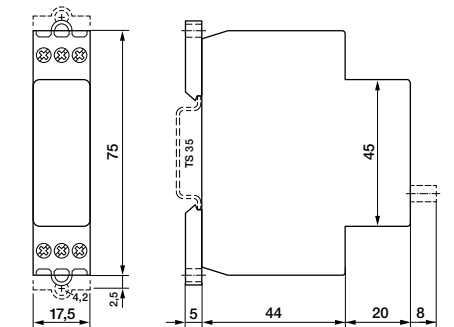


fig. 4. Dimensions (mm)



Standards and approvals

Standards IEC/EN 60947



AM3

Multifunction | 24 ... 60 V UC | 110 ... 240 V UC | 2 CO

Time data	
Timing functions	fig. 1 1: E 2: A, K 3: W
Timing range	0.5 s ... 60 min
Timing scale	6 min / 60 min

Main circuit	
Number of contacts	2 CO
Contact Material	AgNi
Rated voltage	250 V
Rated current	10 A (total current 12 A)
Minimum load	10 mA, 12 V
Inrush current	16 A, 10 ms
Rated load DC	fig. 2
Rated load AC-1	2500 VA
Mechanical endurance (cycles)	2 x 10 ⁷
Electrical endurance at rated load AC-1 (cycles)	fig. 3

Control circuit		
Nominal voltage	24 ... 60 V UC	220 ... 240 V AC
Operating voltage range	19 ... 75 V	195 ... 265 V
Power consumption AC / DC	1.8 VA / 1.8 W	1.8 VA / 1.8 W
Typ. input current on command input AC / DC	50 / 50 mA	15 / 15 mA
Typ. threshold voltage on command input AC / DC	19 V / 19 V	187 V / 187 V
Rated frequency	40 ... 400 Hz	40 ... 60 Hz

Insulation	
Rated test voltage control / main circuit	2 kV rms / 1 min
Rated test voltage main / main circuit	2 kV rms / 1 min
Rated test voltage open contact	1 kV rms / 1 min
Pollution degree	2
Overvoltage category	III

General data	
Ambient temperature storage	-40 ... 85 °C
Ambient temperature operation	-40 ... 50 °C
Conductor cross section	2.5 mm ² , 2 x 1.5 mm ²
Nominal screw torque	0.4 Nm
Module width	fig. 4
Weight	110 g
Protection degree	IP 20
Housing material	PC

Product references		
Types	Product reference	24-60 220-240
UC supply	AM3/UC...V	✓
AC supply	AM3/AC...V	✓

"..." list control circuit voltage to complete product references.
Other voltages on request. Please contact support@comatreleco.com.

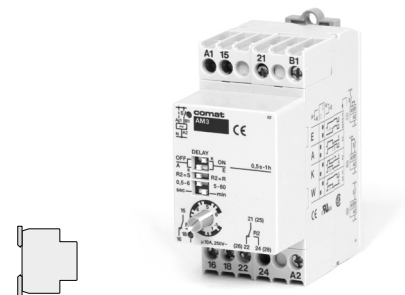


fig. 1. Wiring diagram

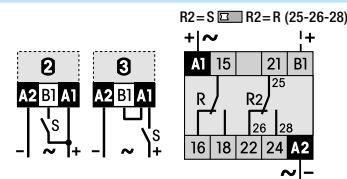


fig. 2. DC load limit curve

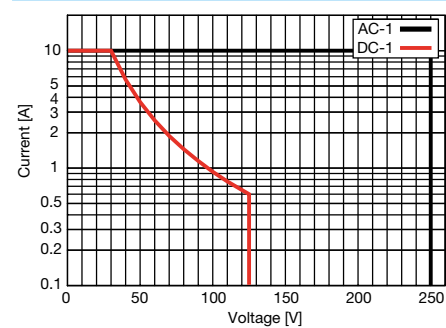


fig. 3. AC voltage endurance

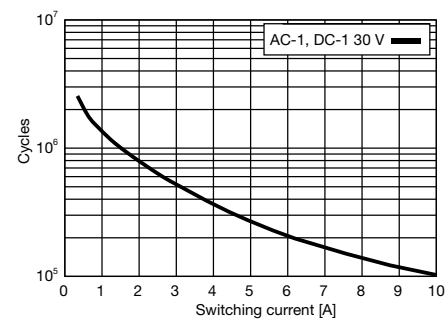
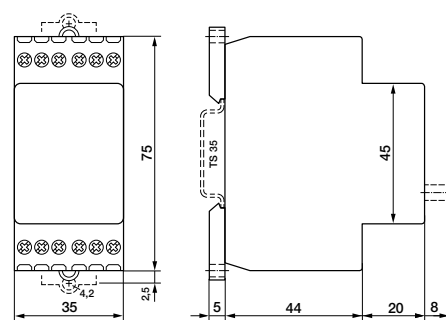


fig. 4. Dimensions (mm)



Standards and approvals

Standards	IEC/EN 60947
Approvals	CE ENEC cULus

CM2

Multifunction | 24 ... 60 V UC | 220 ... 240 V AC | 1 NO + 1 CO

Time data	
Timing functions	fig. 1 2: E, A, K 3: E, W
Timing range	0.3 s ... 12 h
Timing scale	3 s / 12 s / 1.5 min / 12 min / 1.5 h / 12 h

Main circuit	
Number of contacts	1 NO + 1 CO
Contact Material	AgNi
Rated voltage	250 V
Rated current	6 A
Minimum load	10 mA, 12 V
Inrush current	10 A, 10 ms
Rated load DC	100 W, 24 V
Rated load AC-1	1500 VA
Mechanical endurance (cycles)	1 x 10 ⁷
Electrical endurance at rated load AC-1 (cycles)	fig. 3
Electrical endurance at rated load DC-1 (cycles)	1 x 10 ⁵

Control circuit		
Nominal voltage	24 ... 60 V UC	220 ... 240 V AC
Operating voltage range	19 ... 75 V	90 ... 265 V
Power consumption AC / DC	6 VA / 4.8 W	6 VA / 4.8 W
Typ. input current on command input AC / DC	10 / 20 mA	10 / 20 mA
Typ. threshold voltage on command input AC / DC	18 V / 18 V	70 V / 85 V
Rated frequency	40 ... 60 Hz	40 ... 60 Hz

Insulation	
Rated test voltage control / main circuit	2 kV rms / 1 min
Rated test voltage open contact	1 kV rms / 1 min
Pollution degree	2
Overvoltage category	III

General data	
Ambient temperature storage	-40 ... 85 °C
Ambient temperature operation	-40 ... 50 °C
Conductor cross section	2.5 mm ² , 2 x 1.5 mm ²
Nominal screw torque	0.4 Nm
Module width	fig. 4
Weight	139 g
Protection degree	IP 20
Housing material	PC

Product references		
Types	Product reference	24-60 220-240
UC supply	CM2/UC...V	✓
AC supply	CM2/AC...V	✓

"..." list control circuit voltage to complete product references.
Other voltages on request. Please contact support@comatreleco.com.



fig. 1. Wiring diagram

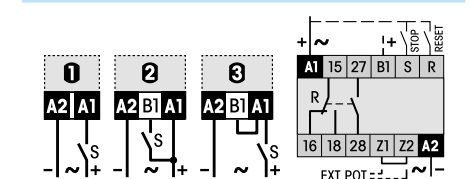
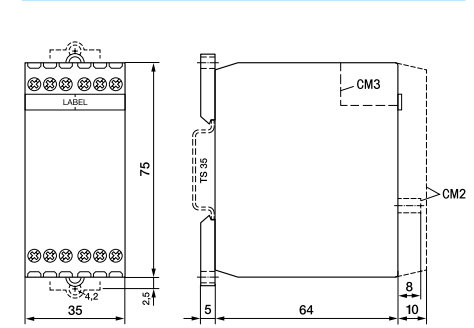


fig. 2. Dimensions (mm)



Standards and approvals

Standards	IEC/EN 60947
Approvals	CE ENEC cULus

CM3

Multifunction | 12 ... 24 V DC | 24 ... 48 V DC, 24 ... 240 V AC | 2 CO

Time data

Timing functions	fig. 1 1: E 2: A, K, N, B1 3: B, W
Timing range	50 ms ... 60 h
Timing scale	0.6 s / 6 s / 60 s / 6 min / 60 min / 6 h / 60 h

Main circuit

Number of contacts	2 CO
Contact Material	AgNi
Rated voltage	250 V
Rated current	5 A
Minimum load	10 mA, 10 V
Inrush current	10 A, 10 ms
Rated load DC	fig. 2
Rated load AC-1	1250 VA
Mechanical endurance (cycles)	15 x 10 ⁶
Electrical endurance at rated load AC-1 (cycles)	fig. 3

Control circuit

Nominal voltage	12 ... 24 V DC	24 ... 48 V DC / 24 ... 240 V AC
Operating voltage range	9.6 ... 28.8 V	19 ... 60 V / 19 ... 250 V
Power consumption AC / DC	- / 1.2 W	15 VA / 1.2 W
Typ. input current on command input AC / DC	10 / 20 mA	10 / 20 mA
Typ. threshold voltage on command input AC / DC	5.8 ... 6.5 V	11 ... 15 V / 13 ... 18 V
Rated frequency	45 ... 63 Hz	45 ... 63 Hz

Insulation

Rated test voltage control / main circuit	2.5 kV rms / 1 min
Rated test voltage main / main circuit	2.5 kV rms / 1 min
Rated test voltage open contact	1 kV rms / 1 min
Pollution degree	2
Overvoltage category	III

General data

Ambient temperature storage	-40 ... 85 °C
Ambient temperature operation	-25 ... 60 °C
Conductor cross section	2.5 mm ² , 2 x 1.5 mm ²
Nominal screw torque	0.4 Nm
Module width	fig. 4
Weight	72 g
Protection degree	IP 20
Housing material	PC

Product references

Types	Product reference	12-24	24-48 / 24-240
DC supply	CM3/DC...V	✓	
UC supply	CM3/DC...V/AC...V		✓

"..." list control circuit voltage to complete product references.
Other voltages on request. Please contact support@comatreleco.com.



fig. 1. Wiring diagram

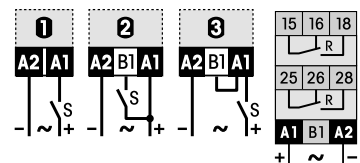


fig. 2. DC load limit curve

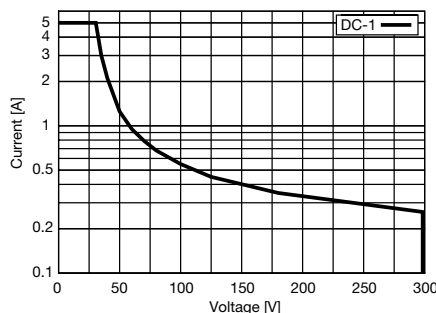


fig. 3. AC voltage endurance

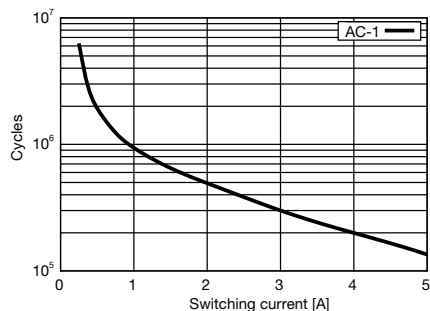
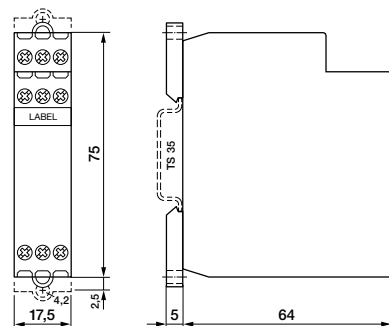


fig. 4. Dimensions (mm)



Standards and approvals

Standards	IEC/EN 60947
Approvals	CE ENEC UL

CPF11

Pulse extension | 24 V DC | 1 PNP Transistor

Time data

Timing functions	A, K, L
Timing range	5 ... 600 ms
Timing scale	60 ms / 600 ms

Main circuit

Number of outputs	1 NO
Output type	PNP Transistor
Output voltage range	10 ... 32 V (Potential of +)
Rated current	0.8 A
Inrush current	2 A, 5 s
Typ. leakage current	1 µA
Mechanical endurance (cycles)	∞
Electrical endurance at rated load DC-1 (cycles)	∞

Control circuit

Nominal voltage	24 V DC
Operating voltage range	10 ... 32 V
Power consumption AC / DC	- / 0.4 W
Typ. threshold voltage on command input AC / DC	- / E1: 10 V, E2: 15 V

Insulation

Pollution degree	2
Overvoltage category	III

General data

Ambient temperature storage	-40 ... 85 °C
Ambient temperature operation	-25 ... 50 °C
Ambient temperature operation derated power	-25 ... 60 °C (I _n 0.7 A)
Conductor cross section	2.5 mm ² , 2 x 1.5 mm ²
Nominal screw torque	0.4 Nm
Module width	fig. 4
Weight	60 g
Protection degree	IP 20
Housing material	PC

Product references

Types	Product reference	24
DC supply	CPF11/DC...V	✓

"..." list control circuit voltage to complete product references.
Other voltages on request. Please contact support@comatreleco.com.

Accessories

Labels	BZS DIN 17.5 mm
--------	-----------------

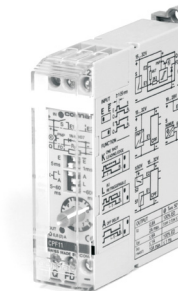


fig. 1. Wiring diagram

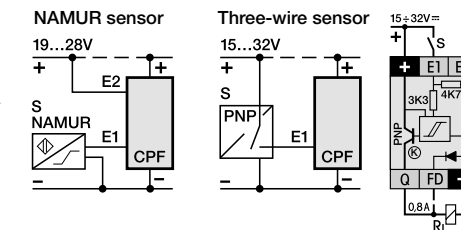
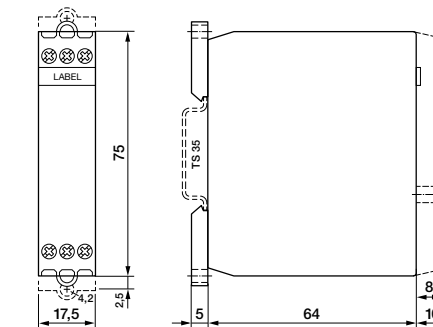


fig. 2. Dimensions (mm)



Standards and approvals

Standards	IEC/EN 60947
Approvals	CE ENEC

CRV4

Multifunction | 24 ... 240 V UC | 1 CO | External potentiometer

Time data	
Timing functions	fig. 1 1: E 2: E, A, K, N, M, B1, F, G, Q, L, S, LS 3: W, B, B2, H
Timing range	50 ms ... 60 h
Timing scale	0.6 s / 6 s / 60 s / 6 min / 60 min / 6 h / 60 h

Main circuit	
Number of contacts	1 CO
Contact Material	AgNi
Rated voltage	250 V
Rated current	6 A
Minimum load	10 mA, 10 V
Inrush current	15 A, 10 ms
Rated load DC	fig. 2
Rated load AC-1	1500 VA
Mechanical endurance (cycles)	3 x 10 ⁷
Electrical endurance at rated load AC-1 (cycles)	fig. 3

Control circuit	
Nominal voltage	24 ... 240 V UC
Operating voltage range	19.2 ... 250 V
Power consumption AC / DC	0.55 VA / 0.55 W
Typ. input current on command input AC / DC	4 / 7 mA
Typ. threshold voltage on command input AC / DC	14.5 V / 17.5 V
Rated frequency	48 ... 63 Hz

Insulation	
Rated test voltage control / main circuit	2 kV rms / 1 min
Rated test voltage open contact	1 kV rms / 1 min
Pollution degree	2
Overvoltage category	III

General data	
Ambient temperature storage	-40 ... 85 °C
Ambient temperature operation	-40 ... 70 °C
Conductor cross section	2.5 mm ² , 2 x 1 mm ²
Nominal screw torque	0.6 Nm
Module width	fig. 4
Weight	50 g
Protection degree	IP 20
Housing material	PC

Product references		
Types	Product reference	24-240
UC supply	CRV4/UC...V	✓

"..." list control circuit voltage to complete product references.
Other voltages on request. Please contact support@comatreleco.com.

Accessories	
External potentiometer	SP-01/100K



fig. 1. Wiring diagram

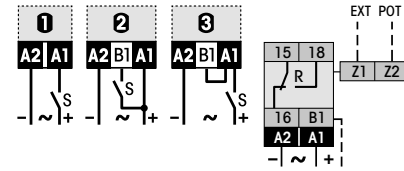


fig. 2. DC load limit curve

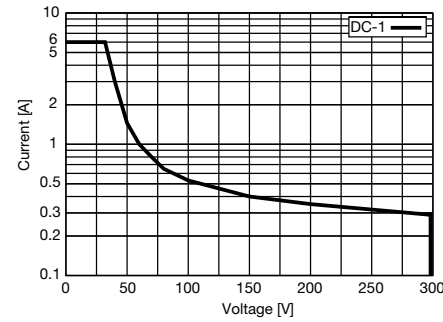


fig. 3. AC voltage endurance

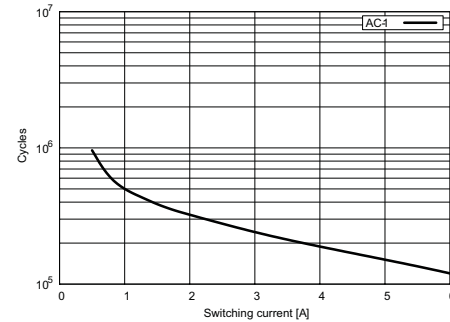
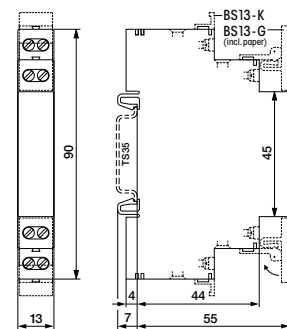


fig. 4. Dimensions (mm)



Standards and approvals

Standards	IEC/EN 60947
Approvals	CE ENEC RA us

CSV4

Multifunction | 12 ... 36 V DC | 1 Mosfet | External potentiometer

Time data	
Timing functions	fig. 1 1: E 2: E, A, K, N, M, B1, F, G, Q, L, S, LS 3: W, B, B2, H
Timing range	0.8 ms ... 10 h
Timing scale	0.1 s / 1 s / 10 s / 1 min / 10 min / 1 h / 10 h

Main circuit	
Number of outputs	1 NO
Output type	Mosfet
Output voltage range	10.2 ... 45 V (Potential of A1)
Rated current	1.5 A
Minimum load	1 mA, 10.2 V
Inrush current	4 A, 100 ms
Typ. leakage current	10 µA
Mechanical endurance (cycles)	∞
Electrical endurance at rated load DC-1 (cycles)	∞

Control circuit	
Nominal voltage	12 ... 36 V DC
Operating voltage range	10.2 ... 45 V
Power consumption AC / DC	- / 0.2 W
Typ. input current on command input AC / DC	- / 4 mA
Typ. threshold voltage on command input AC / DC	- / 7.3 V

Insulation	
Rated test voltage control / main circuit	2 kV rms / 1 min
Pollution degree	2
Overvoltage category	III

General data	
Ambient temperature storage	-40 ... 85 °C
Ambient temperature operation	-40 ... 70 °C
Conductor cross section	2.5 mm ² , 2 x 1 mm ²
Nominal screw torque	0.6 Nm
Module width	fig. 2
Weight	50 g
Protection degree	IP 20
Housing material	PC

Product references		
Types	Product reference	12-36
DC supply	CSV4/DC...V	✓

"..." list control circuit voltage to complete product references.
Other voltages on request. Please contact support@comatreleco.com.

Accessories	
External potentiometer	SP-01/100K



fig. 1. Wiring diagram

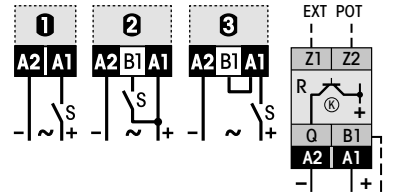
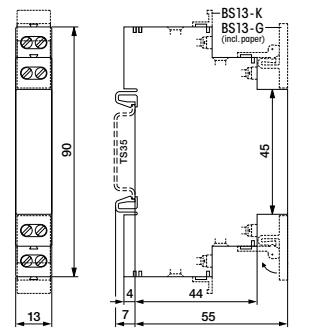


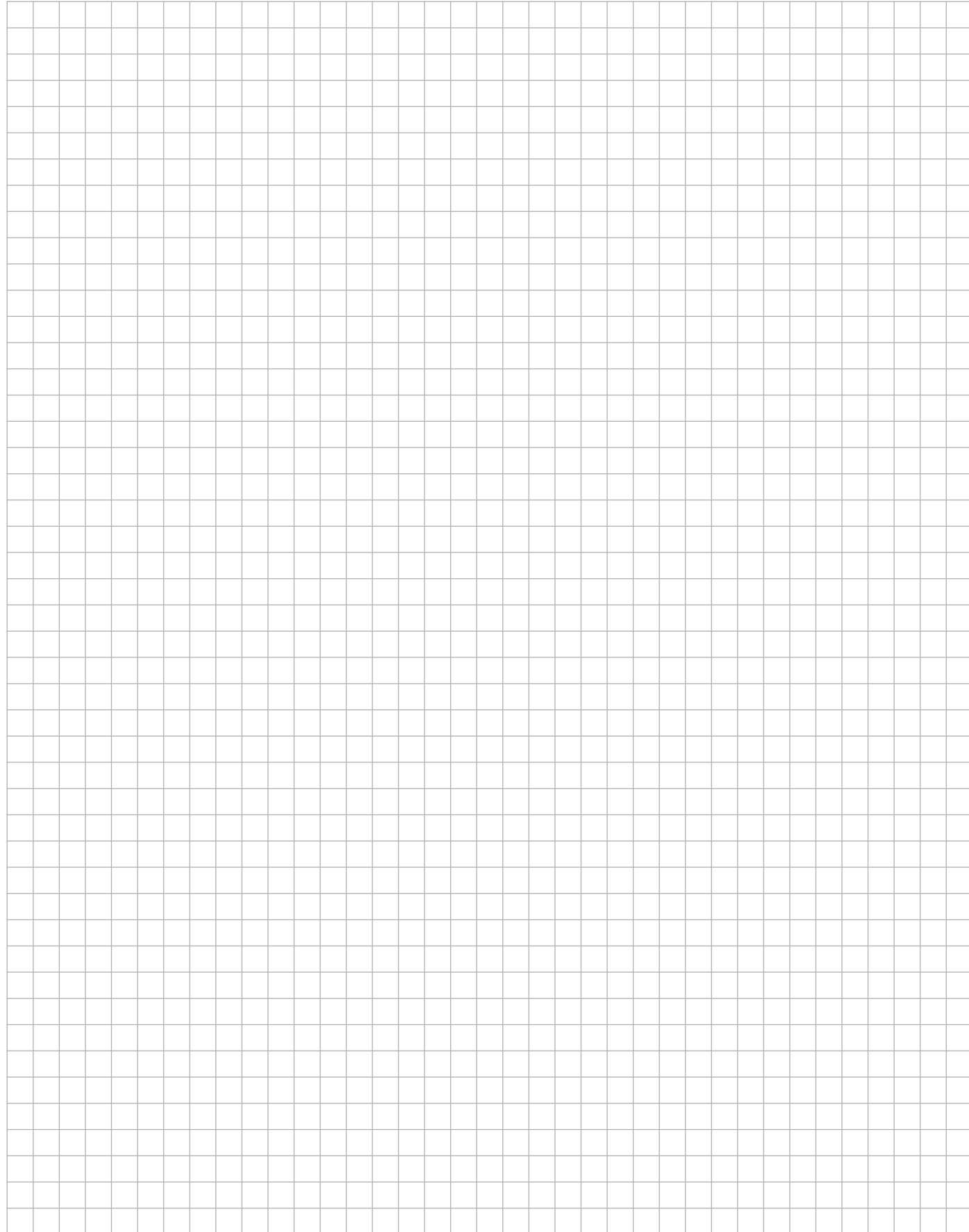
fig. 2. Dimensions (mm)



Standards and approvals

Standards	IEC/EN 60947
Approvals	CE ENEC RA us

Notes



2.3 Star-Delta Relays

Application	Type	Page
CY Series		
Star-delta 24 ... 60 V UC 110 ... 240 V UC 1 NO + 1 CO	CY1	184

Time data	
Timing functions	Y
Timing range	Star time: 0.5 s ... 60 s / switchover time 50 ms / 100 ms
Timing scale	6 s / 60 s

Main circuit	
Number of contacts	1 NO + 1 CO
Contact Material	AgNi
Rated voltage	250 V
Rated current	6 A
Minimum load	10 mA, 10 V
Inrush current	30 A, 10 ms
Rated load DC	fig. 2
Rated load AC-1	1500 VA
Mechanical endurance (cycles)	3 x 10 ⁷
Electrical endurance at rated load AC-1 (cycles)	fig. 3

Control circuit	
Nominal voltage	24 ... 60 V UC 110 ... 240 V UC
Operating voltage range	20 ... 75 V 90 ... 265 V
Power consumption AC / DC	1 VA / 1 W
Rated frequency	48 ... 63 Hz 48 ... 63 Hz

Insulation	
Rated test voltage control / main circuit	2 kV rms / 1 min
Rated test voltage main / main circuit	2 kV rms / 1 min
Rated test voltage open contact	1 kV rms / 1 min
Pollution degree	2
Overvoltage category	III

General data	
Ambient temperature storage	-40 ... 85 °C
Ambient temperature operation	-25 ... 60 °C
Conductor cross section	2.5 mm ² , 2 x 1.5 mm ²
Nominal screw torque	0.4 Nm
Module width	fig. 4
Weight	76 g
Protection degree	IP 20
Housing material	PC

Product references			
Types	Product reference	24-60	110-240
UC supply	CY1/UC...V	✓	✓

"..." list control circuit voltage to complete product references.
Other voltages on request. Please contact support@comatreleco.com.

Accessories	
Labels	BZS DIN 17.5 mm

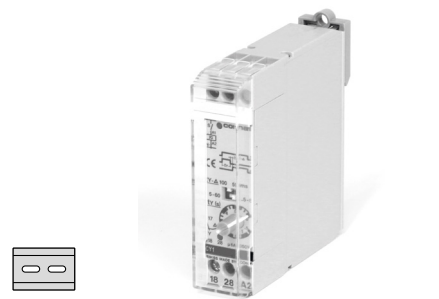


fig. 1. Wiring diagram

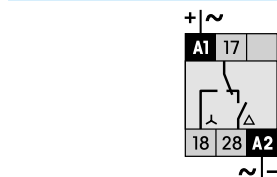


fig. 2. DC load limit curve

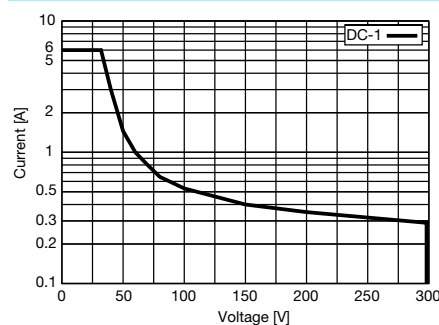


fig. 3. AC voltage endurance

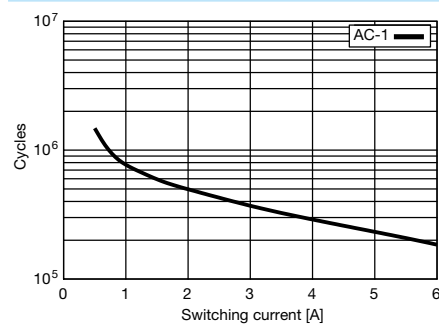
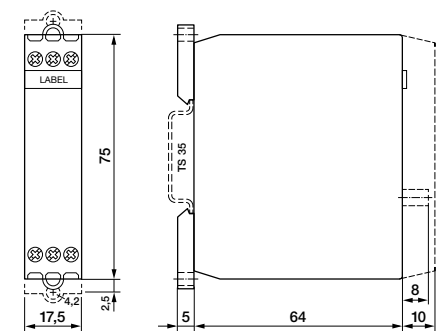


fig. 4. Dimensions (mm)



Standards and approvals

Standards IEC/EN 60947
 Approvals CE ENEC UL

2.4 Time Relays - pluggable

Application	Type	Page
C Series		
Multifunction 24 ... 60 V UC 110 ... 240 V UC 2 CO	C55	186
Multifunction 24 ... 60 V UC 110 ... 240 V UC 1 Mosfet AC and DC	C55.3	187
Multifunction 24 V DC 1 Mosfet	C55.4	188
Multifunction 24 ... 60 V UC 110 ... 240 V UC 2 CO Potential-free control	C56	189
Multifunction 24 ... 60 V UC 110 ... 240 V UC 2 CO Off delay without control voltage	C64	190
Multifunction 24 ... 240 V UC 1 CO	C83	191
Multifunction 24 ... 240 V UC 1 CO	C85	192
CS Series		
Multifunction 12 ... 240 V UC 1 CO External potentiometer	CS2	193
Multifunction 12 ... 240 V UC 2 CO	CS3	194
RS Series		
Multifunction 24 ... 48 V UC 220 ... 240 V AC 1 CO Potential-free control	RS 41-M	195

Time data	
Timing functions	fig. 1 2: E, A, K, W, H, N, M, B, G, F, Q, I, P 3: E, W, H, B, I, P 4: U, V
Timing range	0.01 s ... 60 d
Timing scale	digital

Main circuit	
Number of contacts	2 CO
Contact Material	AgNi
Rated voltage	250 V
Rated current	5 A
Minimum load	10 mA, 12 V
Inrush current	10 A, 10 ms
Rated load DC	fig. 2
Rated load AC-1	1250 VA
Mechanical endurance (cycles)	5 x 10 ⁶
Electrical endurance at rated load AC-1 (cycles)	fig. 3

Control circuit		
Nominal voltage	24 ... 60 V UC	110 ... 240 V UC
Operating voltage range	19 ... 75 V	88 ... 265 V
Power consumption AC / DC	2 VA / 2 W	
Typ. input current on command input AC / DC	6.3 / 6.3 mA	4.2 / 4.2 mA
Typ. threshold voltage on command input AC / DC	10 V / 10 V	40 V / 40 V
Rated frequency	48 ... 400 Hz	48 ... 400 Hz

Insulation	
Rated test voltage control / main circuit	2 kV rms / 1 min
Rated test voltage main / main circuit	2 kV rms / 1 min
Rated test voltage open contact	1 kV rms / 1 min
Pollution degree	2
Overvoltage category	III

General data	
Ambient temperature storage	-40 ... 85 °C
Ambient temperature operation	-25 ... 60 °C
Module width	fig. 4
Weight	80 g
Protection degree	IP 20
Housing material	PC

Product references			
Types	Product reference	24-60	110-240
UC supply	C55/UC...V	✓	✓

"..." list control circuit voltage to complete product references.
Other voltages on request. Please contact support@comatreleco.com.

Accessories	
Sockets	S3-M
Retaining clip	HF-50
Transparent front cover	FA-50
Front panel mounting set	FZ-50L



fig. 1. Wiring diagram

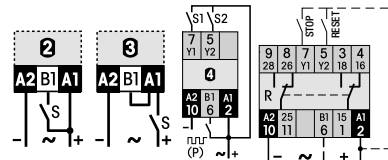


fig. 2. DC load limit curve

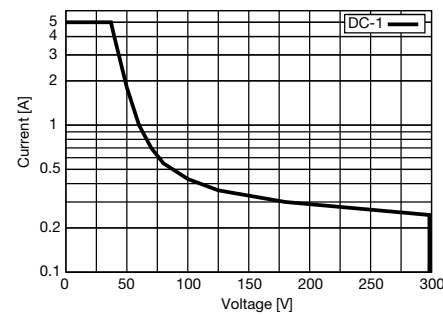


fig. 3. AC voltage endurance

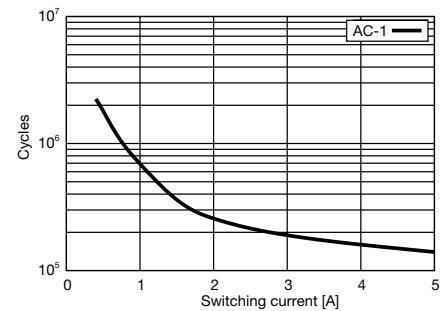
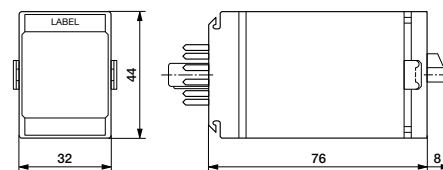


fig. 4. Dimensions (mm)



Standards and approvals

Standards	IEC/EN 60947
Approvals	CE EAC

Time data	
Timing functions	fig. 1 2: E, A, K, W, H, N, M, B, G, F, Q, I, P 3: E, W, H, B, I, P 4: U, V
Timing range	0.01 s ... 60 d
Timing scale	digital

Main circuit	
Number of outputs	1 NO
Output type	Mosfet AC and DC
Output voltage range	10 ... 265 V
Rated current	0.5 A
Minimum load	1 mA, 10 V
Inrush current	6 A, 2 us
Rated load AC-1	132 VA
Mechanical endurance (cycles)	∞
Electrical endurance at rated load AC-1 (cycles)	∞
Electrical endurance at rated load DC-1 (cycles)	∞

Control circuit		
Nominal voltage	24 ... 60 V UC	110 ... 240 V UC
Operating voltage range	19 ... 75 V	88 ... 265 V
Power consumption AC / DC	2 VA / 2 W	
Typ. input current on command input AC / DC	6.3 / 6.3 mA	4.2 / 4.2 mA
Typ. threshold voltage on command input AC / DC	10 V / 10 V	40 V / 40 V
Rated frequency	48 ... 400 Hz	48 ... 400 Hz

Insulation	
Rated test voltage control / main circuit	2 kV rms / 1 min
Pollution degree	2
Overvoltage category	III

General data	
Ambient temperature storage	-40 ... 85 °C
Ambient temperature operation	-25 ... 60 °C
Module width	fig. 2
Weight	80 g
Protection degree	IP 20
Housing material	PC

Product references			
Types	Product reference	24-60	110-240
UC supply	C55.3/UC...V	✓	✓

"..." list control circuit voltage to complete product references.
Other voltages on request. Please contact support@comatreleco.com.

Accessories	
Sockets	S3-M
Retaining clip	HF-50
Transparent front cover	FA-50
Front panel mounting set	FZ-50L



fig. 1. Wiring diagram

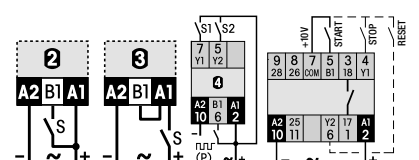
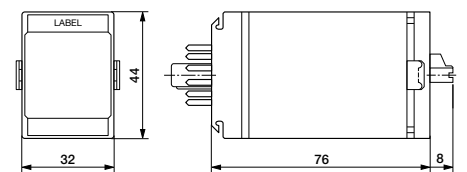


fig. 2. Dimensions (mm)



Standards and approvals

Standards	IEC/EN 60947
Approvals	CE EAC

C55.4

Multifunction | 24 V DC | 1 Mosfet

Time data	
Timing functions	fig. 1 2: E, A, K, W, H, N, M, B, G, F, Q, I, P 3: E, W, H, B, I, P 4: U, V
Timing range	0.01 s ... 60 d
Timing scale	digital

Main circuit	
Number of outputs	1 NO
Output type	Mosfet
Output voltage range	19 ... 30 V
Rated current	2 A
Minimum load	1 mA, 5 V
Inrush current	40 A, 150 us
Mechanical endurance (cycles)	∞
Electrical endurance at rated load AC-1 (cycles)	∞

Control circuit	
Nominal voltage	24 V DC
Operating voltage range	19 ... 30 V
Power consumption AC / DC	- / 300 mW
Typ. input current on command input AC / DC	- / 5.5 mA
Typ. threshold voltage on command input AC / DC	- / 10 V

Insulation	
Pollution degree	2
Overvoltage category	III

General data	
Ambient temperature storage	-40 ... 85 °C
Ambient temperature operation	-25 ... 60 °C
Module width	fig. 2
Weight	80 g
Protection degree	IP 20
Housing material	PC

Product references		
Types	Product reference	24
DC supply	C55.4/DC...V	✓

"..." list control circuit voltage to complete product references.
Other voltages on request. Please contact support@comatreleco.com.

Accessories	
Sockets	S3-M
Retaining clip	HF-50
Transparent front cover	FA-50
Front panel mounting set	FZ-50L



fig. 1. Wiring diagram

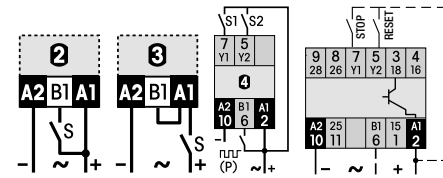
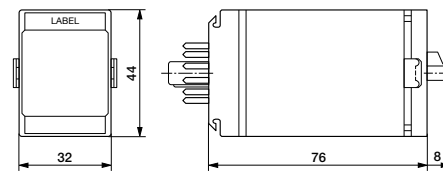


fig. 2. Dimensions (mm)



Standards and approvals

Standards	IEC/EN 60947
Approvals	CE EAC

C56

Multifunction | 24 ... 60 V UC | 110 ... 240 V UC | 2 CO | Potential-free control

Time data	
Timing functions	fig. 1 6: E, A, K, W, H, N, M, B, G, F, Q, I, P 7: E, W, H, B, I, P 5: U, V
Timing range	0.01 s ... 60 d
Timing scale	digital

Main circuit	
Number of contacts	2 CO
Contact Material	AgNi
Rated voltage	250 V
Rated current	5 A
Minimum load	10 mA, 12 V
Inrush current	10 A, 10 ms
Rated load DC	fig. 2
Rated load AC-1	1250 VA
Mechanical endurance (cycles)	5 x 10 ⁶
Electrical endurance at rated load AC-1 (cycles)	fig. 3

Control circuit	
Nominal voltage	24 ... 60 V UC 110 ... 240 V UC
Operating voltage range	19 ... 75 V 88 ... 265 V
Power consumption AC / DC	2 VA / 2 W
Typ. input current on command input AC / DC	n.A.
Typ. threshold voltage on command input AC / DC	n.A. (10 V from COM)
Rated frequency	48 ... 400 Hz 48 ... 400 Hz

Insulation	
Rated test voltage control / main circuit	2 kV rms / 1 min
Rated test voltage main / main circuit	2 kV rms / 1 min
Rated test voltage open contact	1 kV rms / 1 min
Pollution degree	2
Overvoltage category	III

General data	
Ambient temperature storage	-40 ... 85 °C
Ambient temperature operation	-25 ... 60 °C
Module width	fig. 4
Weight	80 g
Protection degree	IP 20
Housing material	PC

Product references		
Types	Product reference	24-60 110-240
UC supply	C56/UC...V	✓ ✓

"..." list control circuit voltage to complete product references.
Other voltages on request. Please contact support@comatreleco.com.

Accessories	
Sockets	S3-M
Retaining clip	HF-50
Transparent front cover	FA-50
Front panel mounting set	FZ-50L



fig. 1. Wiring diagram

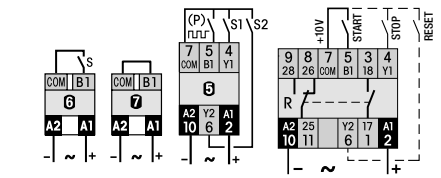


fig. 2. DC load limit curve

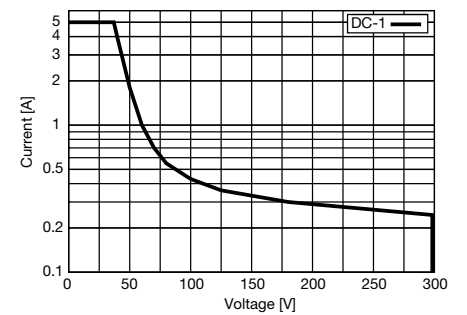


fig. 3. AC voltage endurance

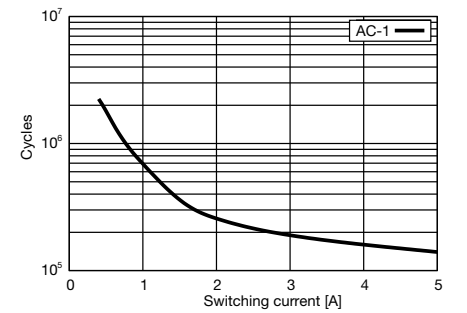
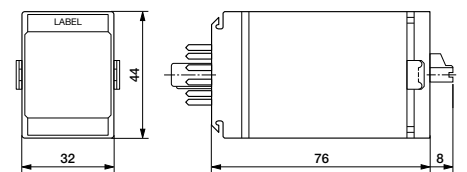


fig. 4. Dimensions (mm)



Standards and approvals

Standards	IEC/EN 60947
Approvals	CE EAC

C64

Multifunction | 24 ... 60 V UC | 110 ... 240 V UC | 2 CO | Off delay without control voltage

Time data	
Timing functions	A, N
Timing range	0.1 s ... 20 min
Timing scale	1.2 s / 12 s / 120 s / 20 min

Main circuit	
Number of contacts	2 CO
Contact Material	AgNi
Rated voltage	250 V
Rated current	5 A
Minimum load	10 mA, 12 V
Inrush current	10 A, 10 ms
Rated load DC	fig. 2
Rated load AC-1	1250 VA
Mechanical endurance (cycles)	5 x 10 ⁶
Electrical endurance at rated load AC-1 (cycles)	fig. 3

Control circuit		
Nominal voltage	24 ... 60 V UC	110 ... 240 V UC
Operating voltage range	20 ... 75 V	88 ... 265 V
Power consumption AC / DC	0.9 VA / 0.9 W	1.2 VA / 1.2 W
Rated frequency	48 ... 400 Hz	48 ... 400 Hz

Insulation	
Rated test voltage control / main circuit	2 kV rms / 1 min
Rated test voltage main / main circuit	2 kV rms / 1 min
Rated test voltage open contact	1 kV rms / 1 min
Pollution degree	2
Overtoltage category	III

General data	
Ambient temperature storage	-40 ... 85 °C
Ambient temperature operation	-25 ... 60 °C
Module width	fig. 4
Weight	75 g
Protection degree	IP 20
Housing material	PC

Product references		
Types	Product reference	24-60 110-240
UC supply	C64/UC...V	✓ ✓

"..." list control circuit voltage to complete product references.
Other voltages on request. Please contact support@comatreleco.com.

Accessories	
Sockets	S3-M
Retaining clip	HF-50
Transparent front cover	FA-50
Front panel mounting set	FZ-50L

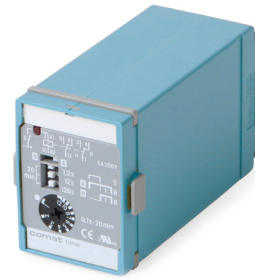


fig. 1. Wiring diagram

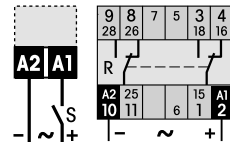


fig. 2. DC load limit curve

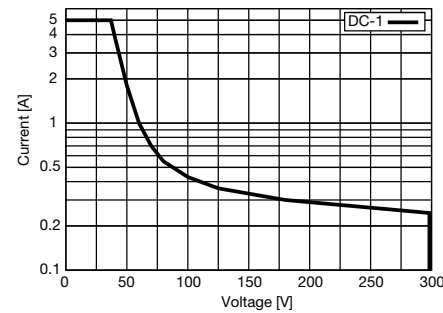


fig. 3. AC voltage endurance

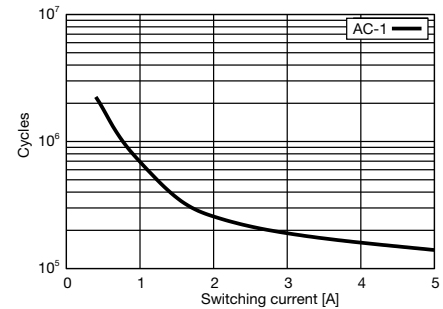
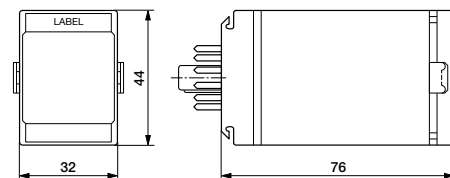


fig. 4. Dimensions (mm)



Standards and approvals

Standards IEC/EN 60947
Approvals CE ENEC

C83

Multifunction | 24 ... 240 V UC | 1 CO

Time data	
Timing functions	fig. 1 2: E, A, N, L, F, K, G, B1, Q 3: E, W, H, B
Timing range	50 ms ... 60 h
Timing scale	0.6 s / 6 s / 60 s / 6 min / 60 min / 6 h / 60 h

Main circuit	
Number of contacts	1 CO
Contact Material	AgNi
Rated voltage	250 V
Rated current	8 A
Minimum load	10 mA, 10 V
Inrush current	30 A, 10 ms
Rated load DC	fig. 2
Rated load AC-1	2000 VA
Mechanical endurance (cycles)	3 x 10 ⁷
Electrical endurance at rated load AC-1 (cycles)	fig. 3

Control circuit	
Nominal voltage	24 ... 240 V UC
Operating voltage range	20 ... 265 V
Power consumption AC / DC	9 VA / 1.6 W
Typ. input current on command input AC / DC	6.5 / 3.5 mA
Typ. threshold voltage on command input AC / DC	18 V / 18 V
Rated frequency	45 ... 63 Hz

Insulation	
Rated test voltage control / main circuit	2 kV rms / 1 min
Rated test voltage open contact	1 kV rms / 1 min
Pollution degree	2
Overtoltage category	III

General data	
Ambient temperature storage	-40 ... 85 °C
Ambient temperature operation	-25 ... 60 °C
Module width	fig. 4
Weight	60 g
Protection degree	IP 20
Housing material	PC

Product references		
Types	Product reference	24-240
UC supply	C83/UC...V	✓

"..." list control circuit voltage to complete product references.
Other voltages on request. Please contact support@comatreleco.com.

Accessories	
Sockets	S7-C

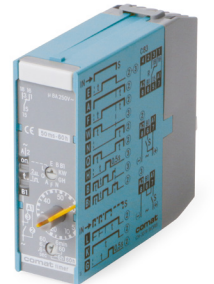


fig. 1. Wiring diagram

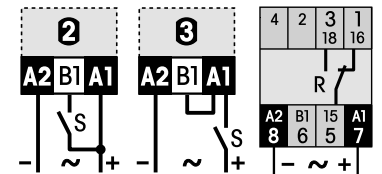


fig. 2. DC load limit curve

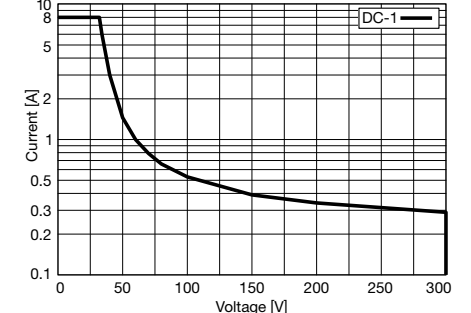


fig. 3. AC voltage endurance

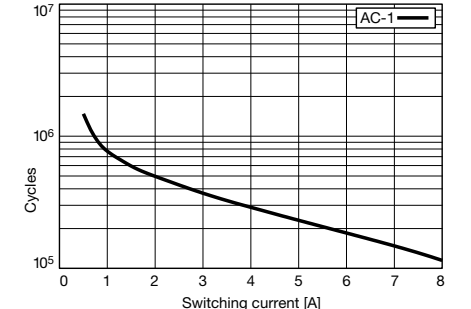
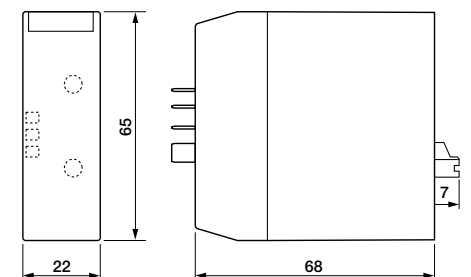


fig. 4. Dimensions (mm)



Standards and approvals

Standards IEC/EN 60947
Approvals CE ENEC ULus

C85

Multifunction | 24 ... 240 V UC | 1 CO

Time data	
Timing functions	fig. 1 2: F, G, Q, I, P 3: H, I, P
Timing range	50 ms ... 60 h
Timing scale	0.6 s / 6 s / 60 s / 6 min / 60 min / 6 h / 60 h

Main circuit	
Number of contacts	1 CO
Contact Material	AgNi
Rated voltage	250 V
Rated current	8 A
Minimum load	10 mA, 10 V
Inrush current	30 A, 10 ms
Rated load DC	fig. 2
Rated load AC-1	1250 VA
Mechanical endurance (cycles)	3 x 10 ⁷
Electrical endurance at rated load AC-1 (cycles)	fig. 3

Control circuit	
Nominal voltage	24 ... 240 V UC
Operating voltage range	20 ... 265 V
Power consumption AC / DC	9 VA / 1.6 W
Typ. input current on command input AC / DC	6.5 / 3 mA
Typ. threshold voltage on command input AC / DC	18 V / 18 V
Rated frequency	45 ... 63 Hz

Insulation	
Rated test voltage control / main circuit	2 kV rms / 1 min
Rated test voltage open contact	1 kV rms / 1 min
Pollution degree	2
Oversvoltage category	III

General data	
Ambient temperature storage	-40 ... 85 °C
Ambient temperature operation	-25 ... 60 °C
Module width	fig. 4
Weight	63 g
Protection degree	IP 20
Housing material	PC

Product references		
Types	Product reference	24-240
UC supply	C85/UC...V	✓

"..." list control circuit voltage to complete product references.
Other voltages on request. Please contact support@comatreleco.com.

Accessories	
Sockets	S7-C

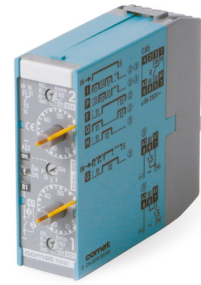


fig. 1. Wiring diagram

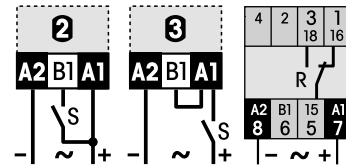


fig. 2. DC load limit curve

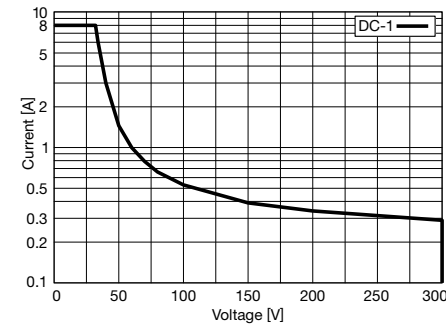


fig. 3. AC voltage endurance

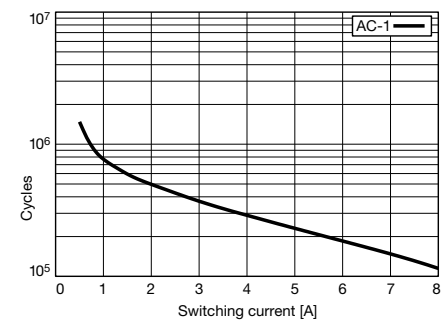
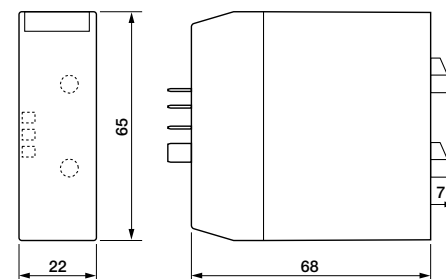


fig. 4. Dimensions (mm)



Standards and approvals

Standards	IEC/EN 60947
Approvals	CE ENEC ULus

CS2

Multifunction | 12 ... 240 V UC | 1 CO | External potentiometer

Time data	
Timing functions	fig. 1 1: E, W, B, B2 2: A, E, K, N
Timing range	50 ms ... 60 h
Timing scale	0.6 s / 6 s / 60 s / 6 min / 60 min / 6 h / 60 h

Main circuit	
Number of contacts	1 CO
Contact Material	AgNi
Rated voltage	250 V
Rated current	8 A
Minimum load	10 mA, 10 V
Inrush current	30 A, 10 ms
Rated load DC	fig. 2
Rated load AC-1	2000 VA
Mechanical endurance (cycles)	3 x 10 ⁷
Electrical endurance at rated load AC-1 (cycles)	fig. 3

Control circuit	
Nominal voltage	12 ... 240 V UC
Operating voltage range	10.2 ... 265 V
Power consumption AC / DC	0.9 VA / 1.6 W
Typ. input current on command input AC / DC	6 / 2 mA
Typ. threshold voltage on command input AC / DC	6.5 V / 7 V
Rated frequency	45 ... 63 Hz

Insulation	
Rated test voltage control / main circuit	2.5 kV rms / 1 min
Rated test voltage open contact	1 kV rms / 1 min
Pollution degree	2
Oversvoltage category	III

General data	
Ambient temperature storage	-40 ... 85 °C
Ambient temperature operation	-25 ... 60 °C
Module width	fig. 4
Weight	75 g
Protection degree	IP 20
Housing material	PC

Product references		
Types	Product reference	12-240
UC supply	CS2/UC...V	✓

"..." list control circuit voltage to complete product references.
Other voltages on request. Please contact support@comatreleco.com.

Accessories	
External potentiometer	SP-01/1M
Sockets	S3-M
Retaining clip	HF-50
Transparent front cover	FA-50
Front panel mounting set	FZ-50L

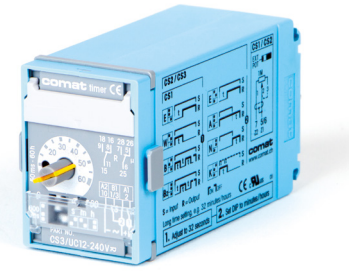


fig. 1. Wiring diagram

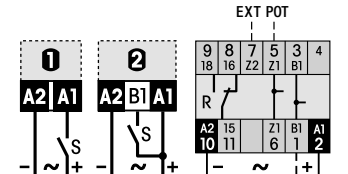


fig. 2. DC load limit curve

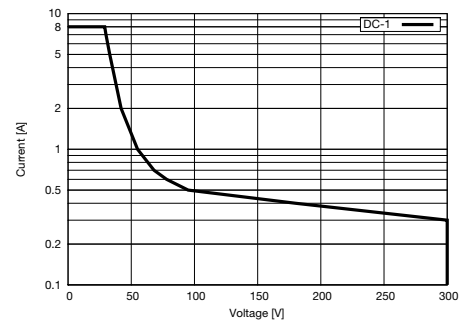


fig. 3. AC voltage endurance

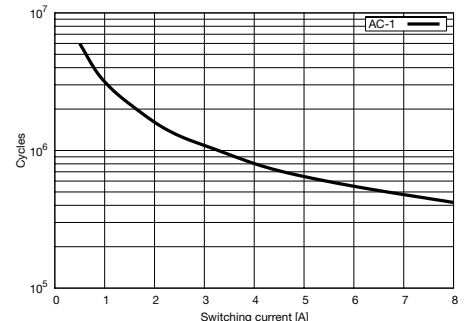
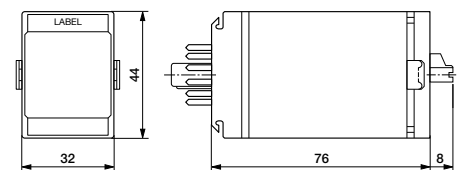


fig. 4. Dimensions (mm)



Standards and approvals

Standards	IEC/EN 60947
Approvals	CE ENEC ULus

Time data	
Timing functions	fig. 1 1: E, W, B, B2 2: A, E, K, N
Timing range	50 ms ... 60 h
Timing scale	0.6 s / 6 s / 60 s / 6 min / 60 min / 6 h / 60 h

Main circuit	
Number of contacts	2 CO
Contact Material	AgNi
Rated voltage	250 V
Rated current	6 A
Minimum load	10 mA, 10 V
Inrush current	10 A, 10 ms
Rated load DC	fig. 2
Rated load AC-1	1500 VA
Mechanical endurance (cycles)	3 x 10 ⁷
Electrical endurance at rated load AC-1 (cycles)	fig. 3

Control circuit	
Nominal voltage	12 ... 240 V UC
Operating voltage range	10.2 ... 265 V
Power consumption AC / DC	0.9 VA / 1.6 W
Typ. input current on command input AC / DC	6 / 2 mA
Typ. threshold voltage on command input AC / DC	6.5 V / 7 V
Rated frequency	45 ... 63 Hz

Insulation	
Rated test voltage control / main circuit	2.5 kV rms / 1 min
Rated test voltage main / main circuit	2.5 kV rms / 1 min
Rated test voltage open contact	1 kV rms / 1 min
Pollution degree	2
Overvoltage category	III

General data	
Ambient temperature storage	-40 ... 85 °C
Ambient temperature operation	-25 ... 60 °C
Module width	fig. 4
Weight	75 g
Protection degree	IP 20
Housing material	PC

Product references		
Types	Product reference	12-240
UC supply	CS3/UC...V	✓

"..." list control circuit voltage to complete product references.
Other voltages on request. Please contact support@comatreleco.com.

Accessories	
Sockets	S3-M
Retaining clip	HF-50
Transparent front cover	FA-50
Front panel mounting set	FZ-50L

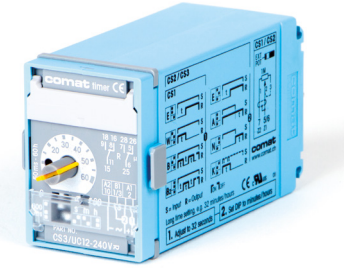


fig. 1. Wiring diagram

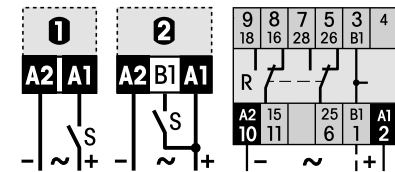


fig. 2. DC load limit curve

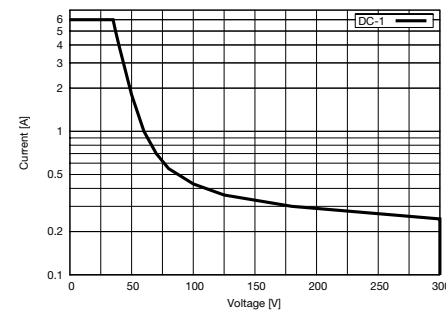


fig. 3. AC voltage endurance

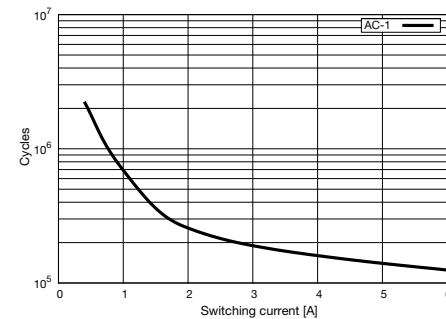
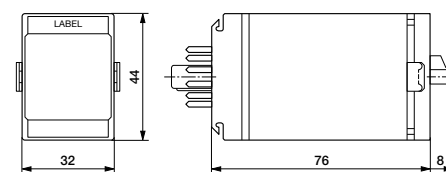


fig. 4. Dimensions (mm)



Standards and approvals

Standards	IEC/EN 60947
Approvals	CE, cULus

Time data	
Timing functions	fig. 1 4: E, 5: A, 6: K, 1: W, I
Timing range	0.1 s ... 15 min
Timing scale	1.5 s / 15 s / 15 min

Main circuit	
Number of contacts	1 CO
Contact Material	AgNi
Rated voltage	250 V
Rated current	6 A
Minimum load	10 mA, 10 V
Inrush current	10 A, 10 ms
Rated load DC	fig. 2
Rated load AC-1	1500 VA
Mechanical endurance (cycles)	2 x 10 ⁷
Electrical endurance at rated load AC-1 (cycles)	fig. 3

Control circuit		
Nominal voltage	24 ... 48 V UC	220 ... 240 V AC
Operating voltage range	19 ... 53 V UC	187 ... 265 V AC
Power consumption AC / DC	0.48 VA / 0.48 W	2.4 VA / 2.4 W
Typ. input current on command input AC / DC	n.A.	
Typ. threshold voltage on command input AC / DC	n.A. (8 V from Terminal 4)	
Rated frequency	45 ... 63 Hz	45 ... 63 Hz

Insulation	
Rated test voltage control / main circuit	2 kV rms / 1 min
Rated test voltage open contact	1 kV rms / 1 min
Pollution degree	2
Overvoltage category	III

General data	
Ambient temperature storage	-40 ... 85 °C
Ambient temperature operation	-25 ... 60 °C
Module width	fig. 4
Weight	75 g
Protection degree	IP 20
Housing material	PC

Product references		
Types	Product reference	24-48 220-240
UC supply	RS 41-M/UFK UC...V	✓
AC supply	RS 41-M/ATX AC...V	✓

"..." list control circuit voltage to complete product references.
Other voltages on request. Please contact support@comatreleco.com.

Accessories	
Sockets	S3-M
Retaining clip	HF-50



fig. 1. Wiring diagram

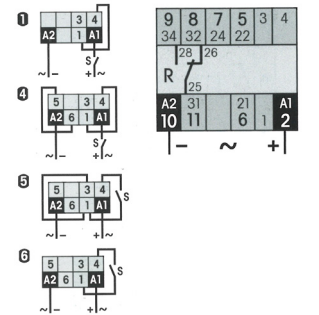


fig. 2. DC load limit curve

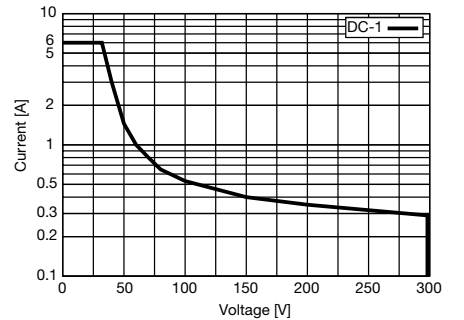


fig. 3. AC voltage endurance

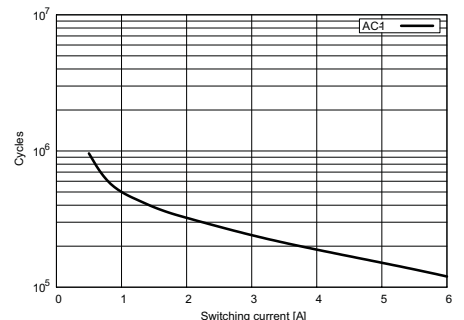
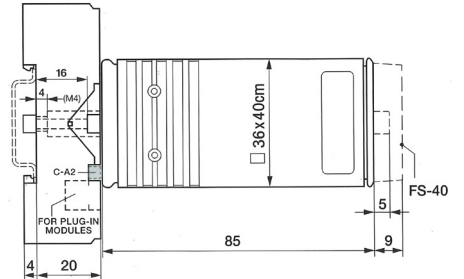


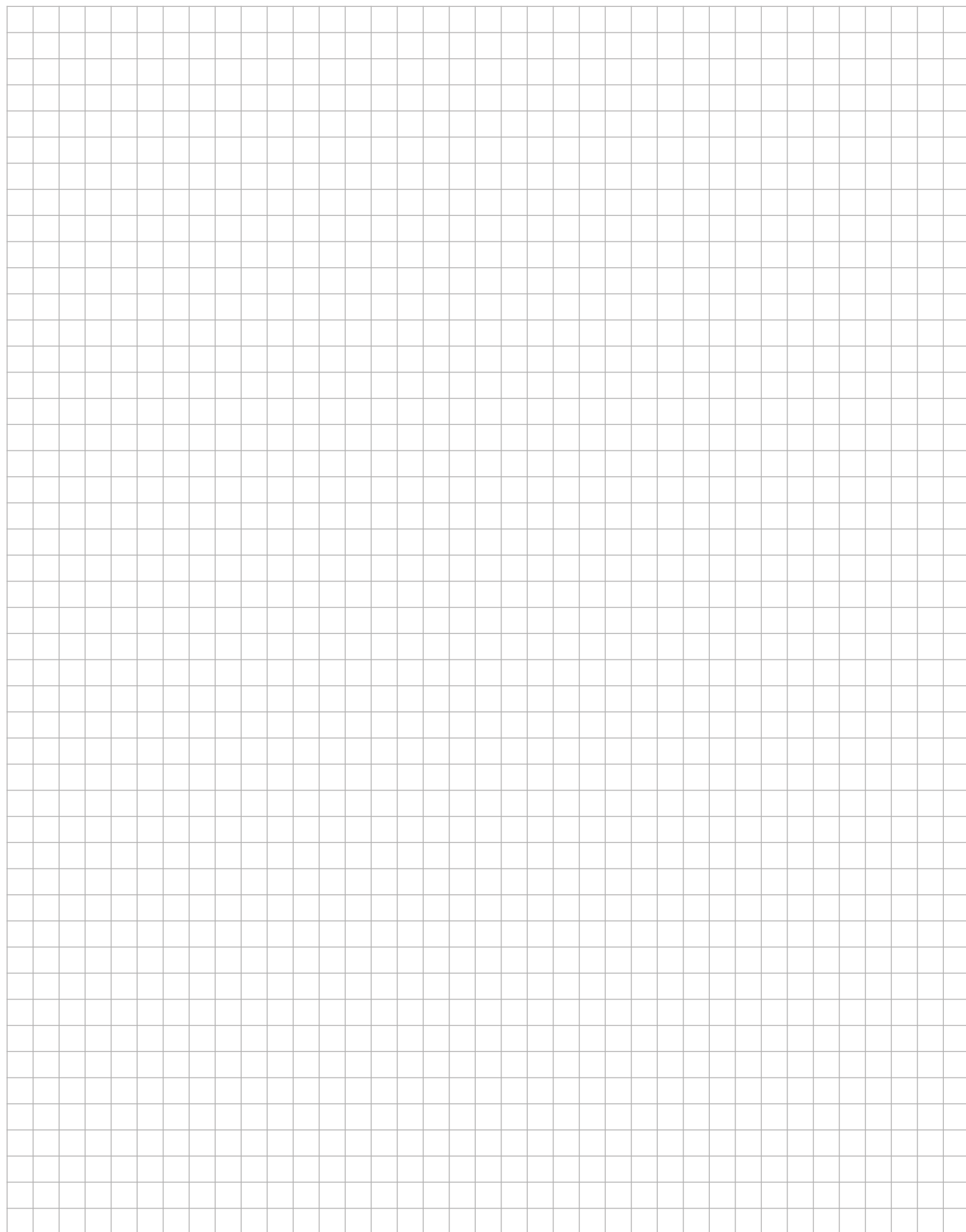
fig. 4. Dimensions (mm)



Standards and approvals

Standards	IEC/EN 60947
Approvals	CE

Notes



2.5 Timers & Twilight Switches

Application	Type	Page
CPU Series		
Digital timer 230 V AC 1 CO	CPU	198
QSU Series		
Mechanical timer 230 V AC 1 CO	QSU	199
EDS Series		
Mechanical timer 230 V AC 1 CO	EDS17	200
Mechanical timer 230 V AC 1 CO	EDS35	201

CPU

Digital Timer 16 A / 230 V AC-1

Type	CPU 35WU-JS	CPU 35W2U-JS	CPU 35WU-LCD	CPU 35W2U-LCD
	Digital Weekly Menu-guided timer, multilingual	Digital Weekly Timer menu-driven, two-channel, multilingual	Digital Weekly timer	Digital Weekly Timer two-channel
Time program	Week, cycle and random program Permanent operation and holiday program pulse 1...99 s Automatic leap year correction Hour meter and maintenance program External input for switch or button		Week	Week
Memory Spaces	64	64	20	20
Shortest switching time	1 min	1 min	1 sec	1 sec
Summer/winter time changeover	automatic	automatic	automatic	automatic
Power reverse	6 Years	6 Years	15 Days	15 Days
Number of contacts	1	2	1	2
Load AC-1	16 A / 230 V	16 A / 230 V	16 A / 230 V	16 A / 230 V
Operating voltage	230 V AC	230 V AC	230 V AC	230 V AC
Operating temperature	0...+50 °C	0...+50 °C	-10...+50 °C (No ice)	-10...+50 °C (No ice)

Specifications

Protection degree	IP 20
Weight	163 g

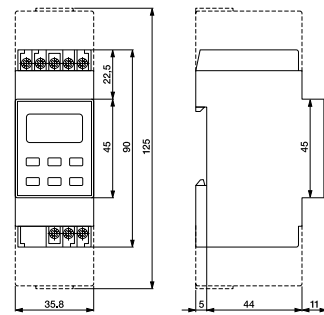
Product References

AC 230 V

- CPU 35 WU-JS/AC230V
- CPU 35 W2U-JS/AC230V
- CPU 35 WU-LCD/AC230V
- CPU 35 W2U-LCD/AC230V



Dimensions (mm)



Technical approvals, conformities



QSU

Mechanical timer 16 A / 230 V AC-1

Type	QSU 35U	QSU 35WU
	Mechanical day timer	Mechanical week timer
Time schedule	Day	Week
Memory Space	1	1
Shortest switching time	30 min	30 min
Summer / winter-time changeover	-	-
power reverse	150 h	150 h
Number of contacts	1	1
Load AC-1	16 A / 230 V	16 A / 230 V
Operating voltage	230 V AC	230 V AC
Operating temperature	0...+50 °C	0...+50 °C

Specifications

Protection degree	IP 20
Weight	134 g

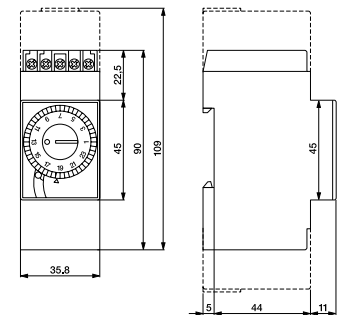
Product References

AC 230 V

- QSU 35 U/AC230V
- QSU 35 WU/AC230V



Dimensions (mm)



Technical approvals, conformities



EDS17

Twilight switch 16 A / 230 V AC-1



Specifications

Setting ranges	0...100 Lux 0...1000 Lux OFF
	Permanent light
Turn-on delay	15 s
Off-delay	30 s
Number of contacts	1
Load AC-1	16 A / 230 V
Operating voltage	230 V AC
Operating temperatur	-10...55 °C (No ice)
Protection degree	IP 20
Weight	100 g

Product References

AC 230 V	EDS17A/AC230V
-----------------	----------------------

Accessories

Light sensor	EDS/LF
--------------	--------



EDS35

Twilight switch 16 A / 230 V AC-1



Specifications

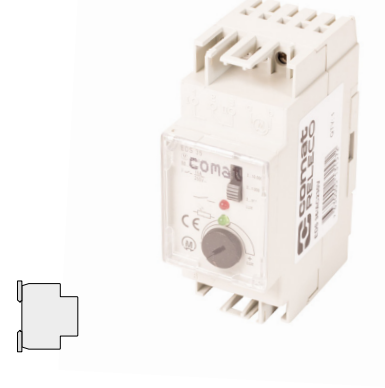
Setting ranges	0...100 Lux 0...1000 Lux 0...10000 Lux
Turn-on delay	8 s
Off-delay	38 s
Number of contacts	1
Load AC-1	16 A / 230 V
Operating voltage	230 V AC
Operating temperatur	-10...55 °C (No ice)
Protection degree	IP 20
Weight	234 g

Product References

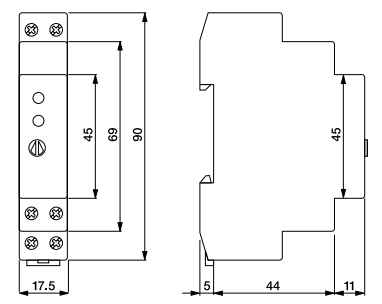
AC 230 V	EDS35/AC230V
-----------------	---------------------

Accessories

Light sensor	EDS/LF
--------------	--------



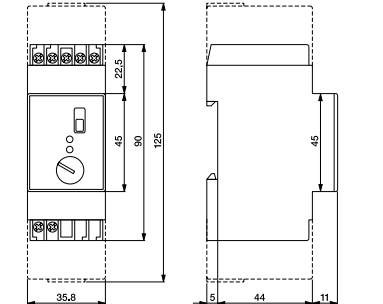
Dimensions (mm)



Technical approvals, conformities



Dimensions (mm)



Technical approvals, conformities



Time data	
Timing functions	fig.1 1: E, B 2: A, K 3: W
Timing range	0.2 s ... 30 min
Timing scale	3 s / 30 s / 3 min / 30 min

Control circuit 1 / 2			
Operating voltage range	9.5 ... 18 V DC	20 ... 65 V UC	90 ... 150 V UC
Power consumption AC / DC	0.2 VA / W	0.4 VA / W	0.3 VA / W
Typ. input current on command input AC / DC	- / 0.2 mA	0.2 / 0.2 mA	0.2 / 0.2 mA
Typ. threshold voltage on command input AC / DC	9 V	18 V	75 V

Control circuit 2 / 2			
Operating voltage range	180 ... 265 V UC	90 ... 265 V UC	
Power consumption AC / DC	0.5 VA / W	0.5 VA / W	
Typ. input current on command input AC / DC	0.2 / 0.2 mA	0.2 / 0.2 mA	
Typ. threshold voltage on command input AC / DC	140 V	75 V	

General data	
Ambient temperature storage	-40 ... 85 °C
Ambient temperature operation	-25 ... 60 °C
Conductor cross section	2.5 mm ²
Nominal screw torque	0.5 Nm
Module width	fig.2
Weight	35 g
Protection degree	IP 20
Housing material	PC

Product references	
Types	Product reference S DC9.5-18 L UC20-65 M 90-150 U 180-265 H 90-265
Off delay	CT2-A30/...V
Blinker	CT2-B30/...V
On delay	CT2-E30/...V
Pulse shaping, one shot	CT2-K30/...V

"..." list control circuit voltage to complete product references.
Other voltages on request. Please contact support@comatreleco.com.

Accessories	
Sockets	S2-B, S2-PO
Retaining clip	HF-33



fig. 1. Wiring diagram

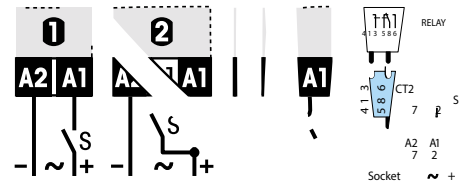
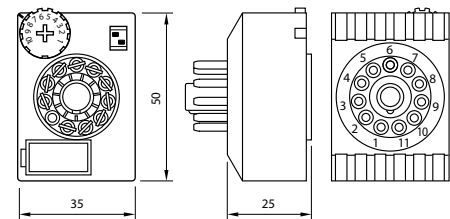


fig. 2. Dimensions (mm)



Standards and approvals

Standards IEC/EN 60947



Time data	
Timing functions	fig.1 1: E, B 2: A, K 3: W
Timing range	0.2 s ... 30 min
Timing scale	3 s / 30 s / 3 min / 30 min

Control circuit 1 / 2			
Operating voltage range	9.5 ... 18 V DC	20 ... 65 V UC	90 ... 150 V UC
Power consumption AC / DC	0.2 VA / W	0.4 VA / W	0.3 VA / W
Typ. input current on command input AC / DC	- / 0.2 mA	0.2 / 0.2 mA	0.2 / 0.2 mA
Typ. threshold voltage on command input AC / DC	9 V	18 V	75 V

Control circuit 2 / 2			
Operating voltage range	180 ... 265 V UC	90 ... 265 V UC	
Power consumption AC / DC	0.5 VA / W	0.5 VA / W	
Typ. input current on command input AC / DC	0.2 / 0.2 mA	0.2 / 0.2 mA	
Typ. threshold voltage on command input AC / DC	140 V	75 V	

General data	
Ambient temperature storage	-40 ... 85 °C
Ambient temperature operation	-25 ... 60 °C
Conductor cross section	2.5 mm ²
Nominal screw torque	0.5 Nm
Module width	fig.2
Weight	35 g
Protection degree	IP 20
Housing material	PC

Product references	
Types	Product reference S DC9.5-18 L UC20-65 M 90-150 U 180-265 H 90-265
Off delay	CT3-A30/...V
Blinker	CT3-B30/...V
On delay	CT3-E30/...V
Pulse shaping, one shot	CT3-K30/...V

"..." list control circuit voltage to complete product references.
Other voltages on request. Please contact support@comatreleco.com.

Accessories	
Sockets	S3-M
Retaining clip	HF-33



fig. 1. Wiring diagram

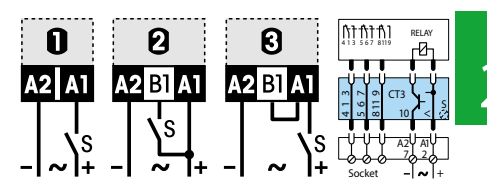
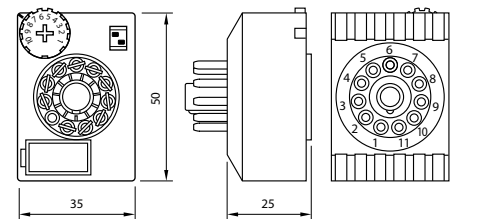


fig. 2. Dimensions (mm)

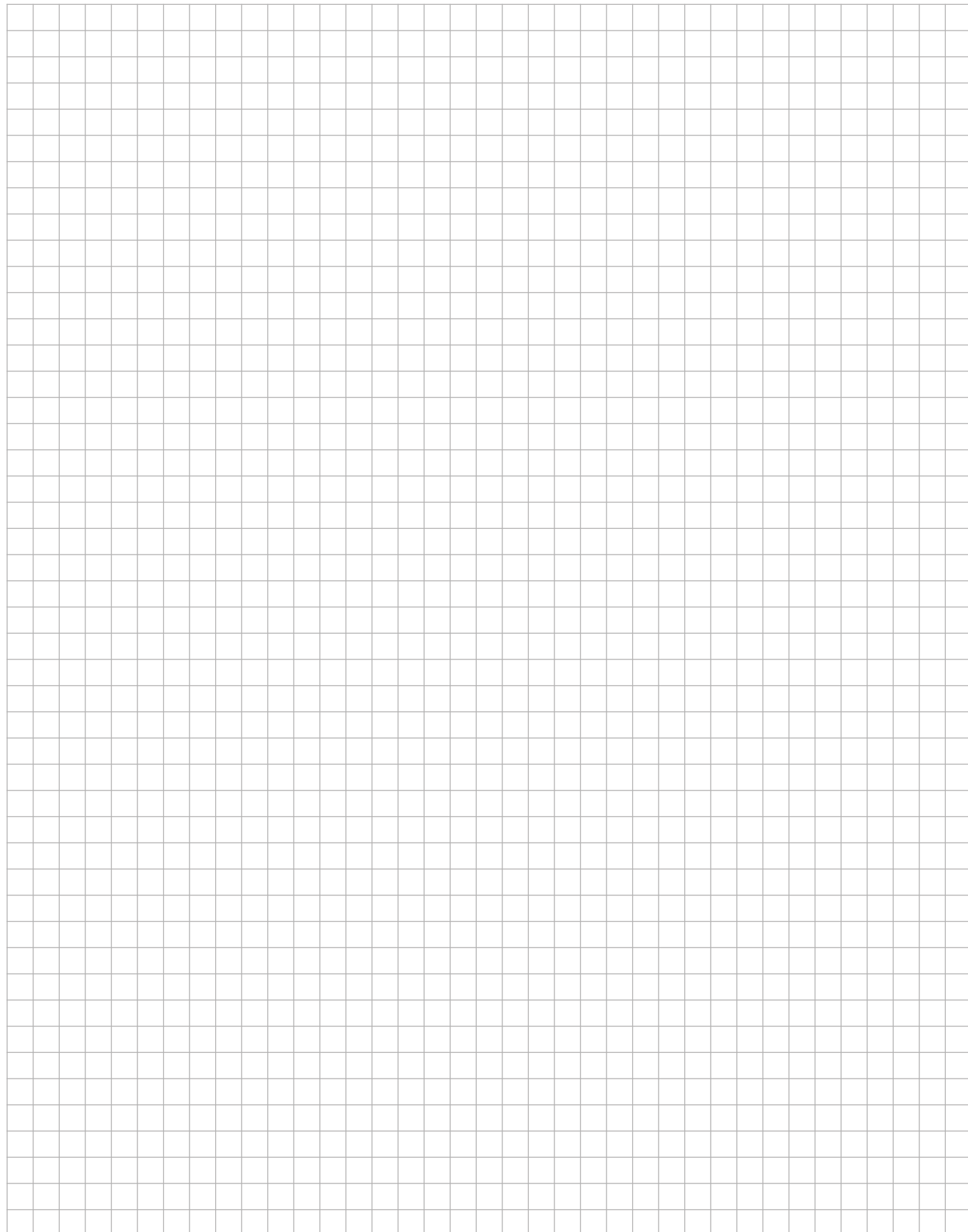


Standards and approvals

Standards IEC/EN 60947



Notes



2.7 Time Modules

Application	Type	Page
CT Series		
Multifunction 24 ... 48 V UC 110 V DC	CT32R	209
Multifunction 24 ... 48 V UC 115 V UC 230 V UC	CT33R	210
Multifunction 24 ... 48 V UC 110 ... 240 V UC	CT36R	211

CT32R

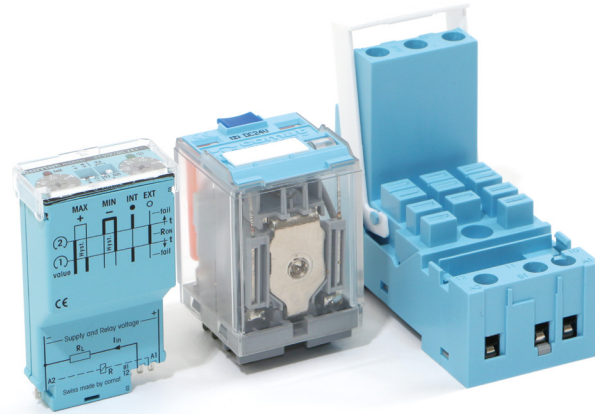
Multifunction | 24 ... 48 V UC | 110 V DC

The modular ComatReleco timer CT System

The time delay relays and monitoring relays consist of plug-in CT electronic modules and 11 pole output relays. Both system components can be combined in a variety of combinations. This allows adapting the system for the specific application.

Subsequent modifications, for example a change from mechanical contacts to solid-state outputs, are possible at any time just by replacing the relay.

This system provides the user a complete universal system with worldwide unmatched flexibility.



The system sockets S3-M0 or C-155 serve as a basis for the secure reception of the electronic modules. The sockets have a 4 pole module slot in which the CT modules lock firmly and vibration proof also without the output relay. Contact is made with reliable twin knife contacts.

With the A2 connector bridge "C-A2", the neutral conductor (N/-) can be connected from socket to socket. It reduces wiring work considerably.

Robust terminals for wires up to 4mm² and spacious labelling are other advantages of this practical ComatReleco modular system.

Clear markings close to the terminal connections on the sockets make it easy to identify the connections for wiring and servicing.

The CT modules are proof of the practical oriented experiences of ComatReleco in the field of industrial electronics. All control and display elements are arranged easy accessible at all times on the front side of the modules. The functions and settings are self-explanatory schematically illustrated on the front and allow to review the set values also during operation.

A transparent cover over the module setting components provides protection from unintentional settings and additionally links the module to the output relay.

Triggering is performed with the operating voltage. (L1 or +). No potential-free contacts are therefore required. The triggering complies to machine standards. Parallel connection to B1 is admissible.

The wide UC voltage range (AC/DC) of the modules give a wide flexibility. It permits the connection to AC or DC supplies and provides a high level of reliability in triggering.

Note: In case of even wider voltage ranges, for example UC 24-240V, triggering currents on B1 are often in the range of 100µA with simultaneous low threshold voltages of less than 20V. Due to capacitive or inductive pick-ups this may lead to unintentional triggering or switching errors caused by insufficient load on the control contacts (It is not seldom that 50V or more can be measured in open lines).

The output relays show the connection diagram and the technical values on the front side, (exception C3 and C5 relays). A colour code indicates an AC coil with red and a DC coil with blue colour. Most of the relays have a lockable test button for manual operation.

The standard contacts have proven its reliability for high switching current applications over many years. The contact material AgNi permits a wide switching range and due to the large dimensioning they are designed for a high number of switching cycles. The high breaking capacity of up to 10A/400V and a low load switching capability of 12V/10mA makes the contact suitable for the use in main circuits as well as for low voltage applications.

The twin contacts are switching the load circuit with 2 independent contact tongues. The switching safety for low currents is therefore 100 times higher compared to a single contact relay. Despite the high switching capacity of up to 6A/250V, these contacts are very suitable to switch low currents and voltages up to 1mA/6V.

The solid-state relays are an alternative to mechanical relays. In the standard version, the relay has a potential-free universal semiconductor output for AC or DC loads. The advantage is a bouncing- and wear-free, overload resistant, short circuit protected output with a practical unlimited life cycle.

Solid-state relays are specially recommended for applications of high switching cycles, for example for repeat cycle timers, flushing lights, but also for high inductive switching loads of solenoid valves, couplings, motors, etc. The solid state relays are also suitable for capacitive loads, for example long power lines, or compensated lighting circuits.

Additional protection circuits of the output or of the load are not necessary in any application for this type of ComatReleco relays.

The solid-state relays are insensitive in any aggressive environment such as chemical plants, sewage plants etc. and are therefore an excellent choice for the employment in such environments.

Time data	
Timing functions	fig. 1 2: E, A, K, N, B1 3: E, W, B
Timing range	1.5 s / 6 s / 15 s / 60 s / 1.5 min / 6 min / 15 min / 60 min
Timing scale	0.15 s ... 60 min

Control circuit		
Nominal voltage	24 ... 48 V UC	110 V DC
Operating voltage range	19 ... 60 V	77 ... 138 V
Power consumption AC / DC	0.3 VA / 0.3 W	- / 0.3 W
Typ. threshold voltage on command input AC / DC	9 V	60 V

General data	
Ambient temperature storage	-40 ... 85 °C
Ambient temperature operation railway version	-40 ... 70 °C
Module width	fig. 2
Weight	25 g
Protection degree	IP 20
Housing material	PC

Product references		
Types	Product reference	24-48 110
DC supply	CT32R/DC...V	✓
UC supply	CT32R/UC...V	✓

"..." list control circuit voltage to complete product references.
Other voltages on request. Please contact support@comatreleco.com.

Accessories	
Sockets	S3-M0, S5-M
Transparent front cover	FS-C



fig. 1. Wiring diagram

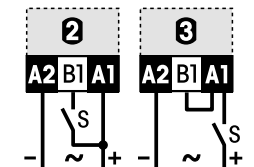
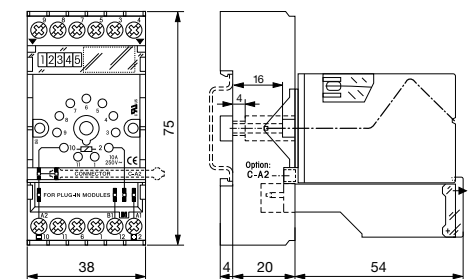


fig. 2. Dimensions (mm)



Standards and approvals

Standards	IEC/EN 50155
Approvals	CE EAC RA us

The train symbol indicates products available in a special railway execution according EN 50155. Please refer to our special railway brochure for details.

CT33R

Multifunction | 24 ... 48 V UC | 115 V UC | 230 V UC

Time data

Timing functions	fig. 1 2: E, A, K, N, B1, F, G, Q, L 3: E, W, B, H		
Timing range	150 ms / 600 ms / 1.5 s / 6 s / 15 s / 60 s / 1.5 min / 6 min / 60 min / 1.5 h / 6 h / 15 h / 60 h		
Timing scale	30 ms ... 60 h		

Control circuit

Nominal voltage	24 ... 48 V UC	115 V UC	230 V UC
Operating voltage range	19 ... 60 V	90 ... 150 V	180 ... 265 V
Power consumption AC / DC	0.3 VA / 0.3 W	0.5 VA / 0.5 W	1 VA / 1 W
Typ. threshold voltage on command input AC / DC	9 V	60 V	100 V

General data

Ambient temperature storage	-40 ... 85 °C
Ambient temperature operation railway version	-40 ... 70 °C
Module width	fig. 2
Weight	25 g
Protection degree	IP 20
Housing material	PC

Product references

Types	Product reference	24-48	115	230
UC supply	CT33R/UC...V	✓	✓	✓

"..." list control circuit voltage to complete product references.
Other voltages on request. Please contact support@comatreleco.com.

Accessories

Sockets	S3-M0, S5-M
Transparent front cover	FS-C



fig. 1. Wiring diagram

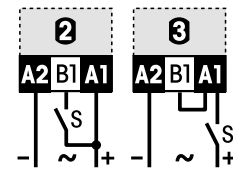
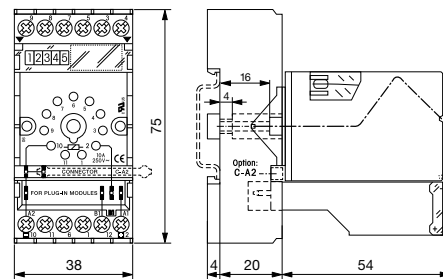


fig. 2. Dimensions (mm)



Standards and approvals

Standards IEC/EN 50155



CT36R

Multifunction | 24 ... 48 V UC | 110 ... 240 V UC

Time data

Timing functions	I, P
Timing range	600 ms / 6 s / 60 s / 6 min / 60 min / 60 h
Timing scale	50 ms ... 60 h

Control circuit

Nominal voltage	24 ... 48 V UC	110 ... 240 V UC
Operating voltage range	19 ... 60 V	82 ... 265 V
Power consumption AC / DC	0.3 VA / 0.3 W	1 VA / 1 W

General data

Ambient temperature storage	-40 ... 85 °C
Ambient temperature operation railway version	-40 ... 70 °C
Module width	fig. 2
Weight	25 g
Protection degree	IP 20
Housing material	PC

Product references

Types	Product reference	24-48	110-240
UC supply	CT36R/UC...V	✓	✓

"..." list control circuit voltage to complete product references.
Other voltages on request. Please contact support@comatreleco.com.

Accessories

Sockets	S3-M0, S5-M
Transparent front cover	FS-C



fig. 1. Wiring diagram

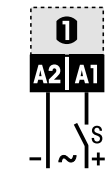
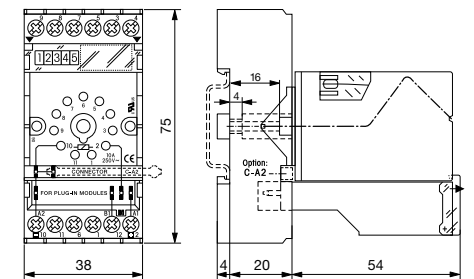


fig. 2. Dimensions (mm)



Standards and approvals

Standards IEC/EN 50155



SP-01

Potentiometer | 100 kΩ | 1 MΩ | 0.2 W

General data

Ambient temperature storage	-40 ... 85 °C
Ambient temperature operation	-25 ... 60 °C
Conductor cross section	2.5 mm ²
Nominal screw torque	0.5 Nm
Module width	fig. 1
Weight	85 g
Protection degree	IP 65

Product references

Types	Product reference	100k	1M
Potentiometer	SP-01/	✓	✓

"..." list resistance to complete product references.

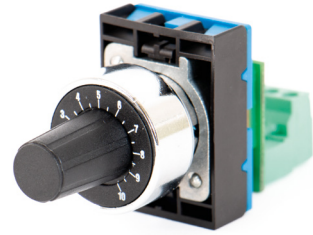
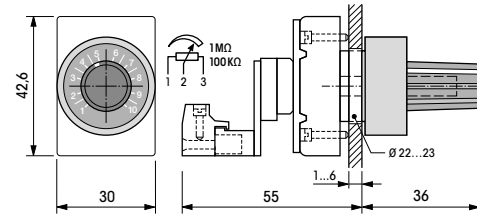


fig. 1. Dimensions (mm)



BZS DIN 17.5 mm

Label

General data

Ambient temperature storage	-40 ... 85 °C
Ambient temperature operation	-25 ... 60 °C
Housing material	PC

Product references

Types	Product reference
Label	BZS DIN 17.5 mm



HF-32

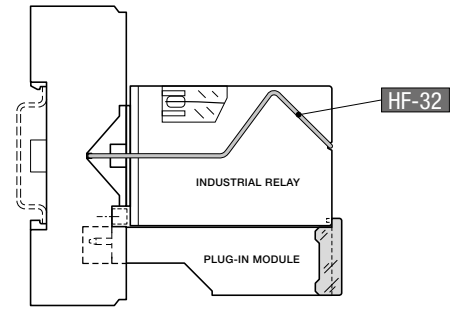
Retaining clip | Steel

General data	
Ambient temperature storage	-40 ... 85 °C
Ambient temperature operation	-25 ... 60 °C
Module width	fig. 1
Weight	2 g
Housing material	Steel

Product references	
Types	Product reference
Retaining clip	HF-32



fig. 1. Dimensions (mm)



HF-33

Retaining clip | Steel

General data	
Ambient temperature storage	-40 ... 85 °C
Ambient temperature operation	-25 ... 60 °C
Module width	fig. 1
Weight	2 g
Housing material	Steel

Product references	
Types	Product reference
Retaining clip	HF-33

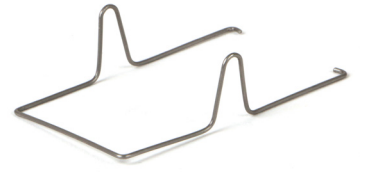
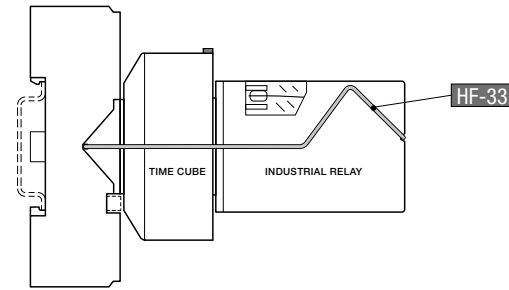


fig. 1. Dimensions (mm)



HF-50

Retaining clip | Steel

General data	
Ambient temperature storage	-40 ... 85 °C
Ambient temperature operation	-25 ... 60 °C
Module width	fig. 1
Weight	2 g
Housing material	Steel

Product references	
Types	Product reference
Retaining clip	HF-50

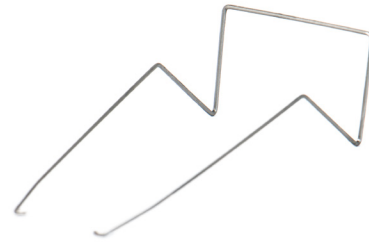
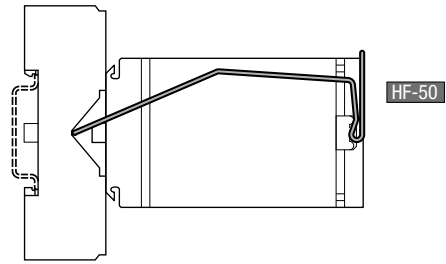


fig. 1. Dimensions (mm)



FA-50

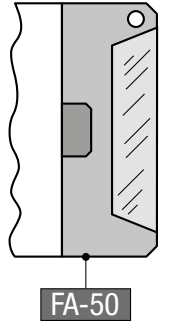
Transparent front cover

General data	
Ambient temperature storage	-40 ... 85 °C
Ambient temperature operation	-25 ... 60 °C
Module width	fig. 1
Weight	5 g
Housing material	PC

Product references	
Types	Product reference
Transparent front cover	FA-50



fig. 1. Dimensions (mm)



FZ-50L

Front panel mounting set | Socket S3-L | Retaining clip

General data	
Ambient temperature storage	-40 ... 85 °C
Ambient temperature operation	-25 ... 60 °C
Module width	fig. 1
Weight	40 g
Housing material	PC

Product references	
Types	Product reference
Front panel mounting set	FZ-50L

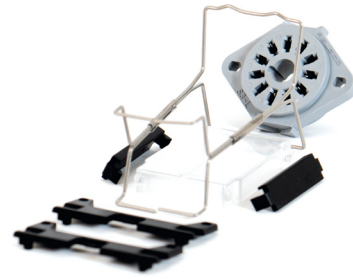
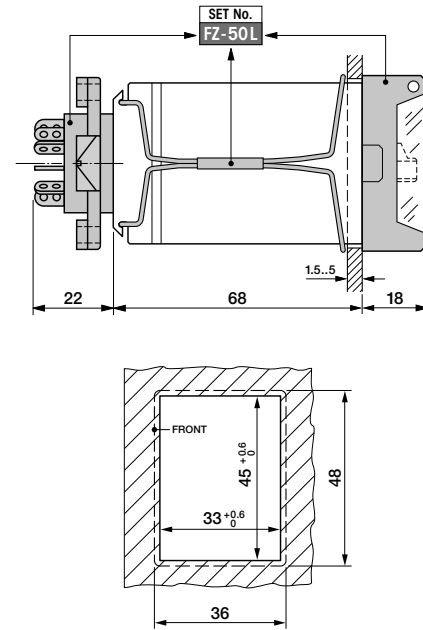


fig. 1. Dimensions (mm)



FS-C

Transparent front cover

General data	
Ambient temperature storage	-40 ... 85 °C
Ambient temperature operation	-25 ... 60 °C
Module width	fig. 1
Weight	5 g

Product references	
Types	Product reference
Transparent front cover, 5 psc	FS-C/5 (BEUTEL/UNIT 5 STK/PCS)

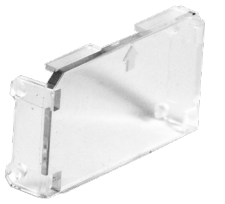
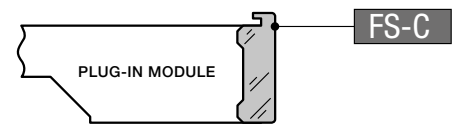
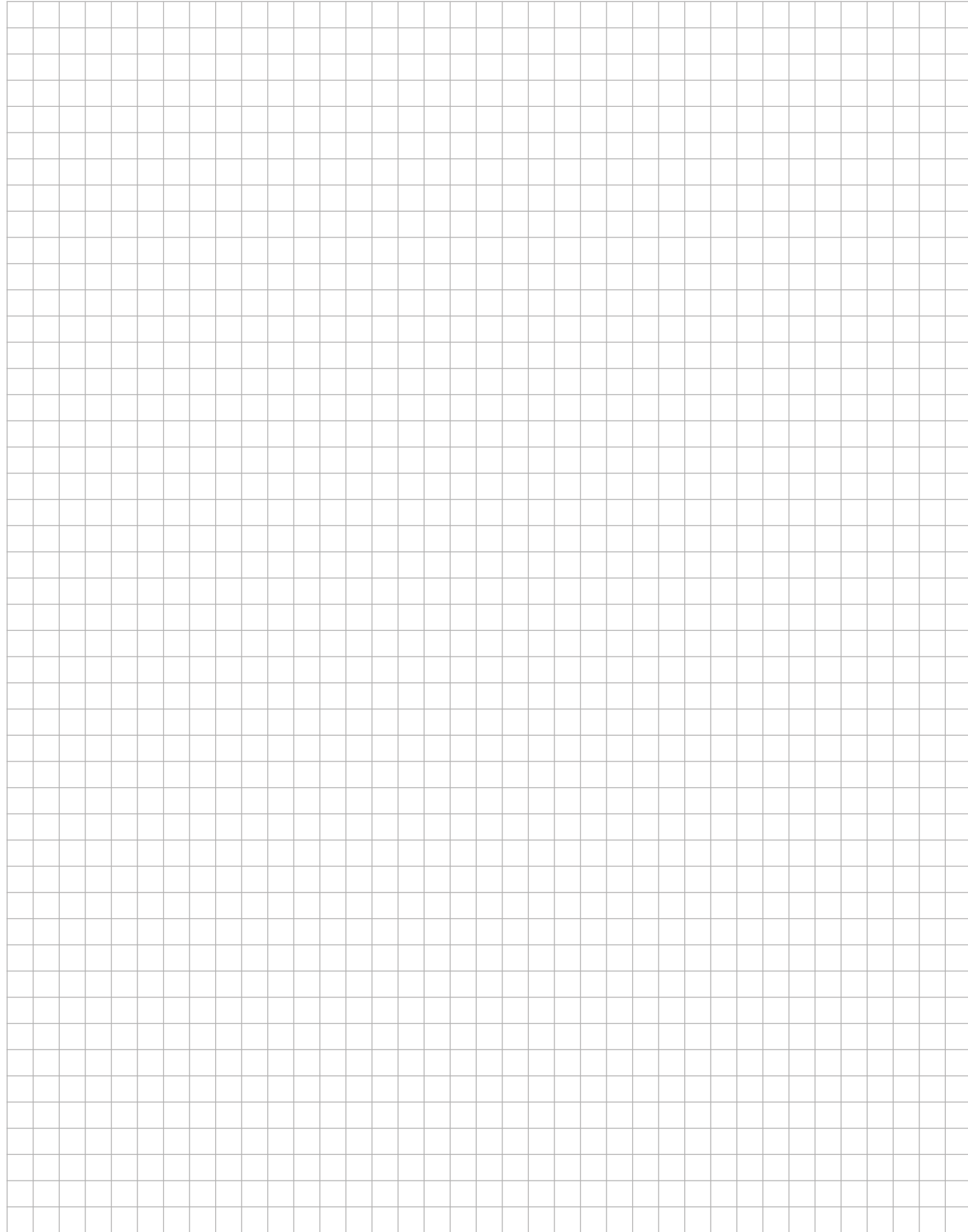


fig. 1. Dimensions (mm)



Notes



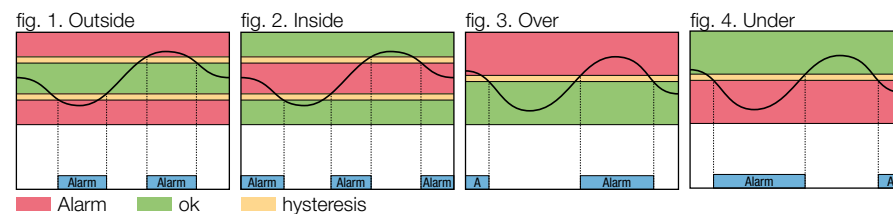
3 Monitoring & Measuring Devices

	Description	MRE-44S	MRR11	MRR1R	MRR32	MRR32R	MRR11	MRR32	MV53	SSU34	SSU31	SSU33L	MRR11	MRR32	TSR19	ESU-D2R	CT515R	CT524R
Monitoring	One phase voltage monitoring		•	•			•		•									
	Three phase voltage monitoring				•	•		•		•		•						
	Four channel voltage measuring	•																
	DC Voltage monitoring		•	•	•	•	•	•			•							•
	One phase current monitoring		•	•									•					
	Three phase current monitoring				•	•								•				
	Four channel current measuring	•																
	DC current monitoring		•	•	•	•								•	•			•
	Phase failure				•	•		•		•	•	•						
	Phase sequence monitoring	•			•	•		•		•	•	•						
	Phase angle monitoring / measuring*	•			•	•		•		•		•						
	Differential voltage monitoring / measuring*	•								•		•						
	Neutral failure monitoring	•								•		•						
	Frequency monitoring / measuring*	•	•	•	•	•	•	•		•		•	•	•				
	Apparent power monitoring / measuring*	•	•	•	•	•												
	Active power monitoring / measuring*	•	•	•	•	•												
	Power factor monitoring / measuring*	•	•	•	•	•												
	Active energy measuring	•																
	THDI / THDU measuring	•																
	PTC monitoring														•			
Earth failure monitoring																•		
Functions	Threshold exceeded "over" fig. 3.	•	•	•	•	•	•	•	•	•		•	•	•	•		•	•
	Threshold undershot "under" fig. 4.	•	•	•	•	•	•	•	•	•	•	•	•	•	•	•	•	•
	Window function "inside" fig. 2.	•	•	•	•	•	•	•					•	•			•	•
	Window function "outside" fig.1.	•	•	•	•	•	•	•					•	•			•	•
	Alarm on-delay	•	•	•	•	•	•	•	•	•		•	•	•		•	•	•
	Alarm off-delay	•	•	•	•	•	•	•	•				•	•				
	Error storage function	•	•	•	•	•	•	•					•	•	•			
	Threshold selectable	•	•	•	•	•	•	•	•				•	•	•	•	•	•
	Threshold fixed										•	•			•			
Power supply	Supply isolated from measuring circuit	•	•	•	•	•	•	•					•	•	•	•		
	Supply from measure circuit								•	•	•	•					•	•
Mounting	DIN rail mounting	•	•	•	•	•	•	•	•				•	•		•		
	Housing according IEC/EN 43880 (electrical distribution mounting)	•	•	•	•	•	•	•						•	•			
	Plug-in (socket mounting)												•	•	•		•	•

3.1 Energy Measuring Device

Application	Type	Page
MRE Series		
Energy measuring 4 voltage channels 4 current channels	MRE-44S	227

*Measuring: MRE-44S only



Overview of features

Due to its compact size and the use of interface technologies such as Modbus TCP, the MRE is perfectly suited for use in installations with multiple loads that require monitoring. To do so, one meter is connected to each corresponding power terminal or load to be measured. Thanks to precise measurements and sophisticated calculation processes, the MRE records highly precise values for the electrical quantities, regardless of the type of load or the grid situation (e.g. power electronics providers). It can be used in all conventional systems operating at 16.7 Hz, 50 Hz and 60 Hz.

As a result of the high accuracy grade (current 0.1,

voltage 0.05) and numerous features that can be enabled – such as an expansion of the grid frequency range from 15 Hz to 400 Hz, a complete power quality analysis and the analysis of harmonics up to 50 kHz – it can be used flexibly for nearly all measuring tasks related to electrical infrastructure in industrial settings as well as office and administrative buildings.

- High-precision measuring, recording and archiving of all important electrical variables. For the identification of savings potentials and deviations in the context of energy management as per DIN EN ISO 50001.
- Monitoring of power quality (PQ) through complete PQ

analysis and comprehensive recording of harmonics up to 50 kHz. Monitoring of individual loads or entire grids allows for the identification of PQ problems or the monitoring of critical components.

- Continuous management through an integrated web browser for visualisation and parameterisation. Quick access to all relevant data at all times via mobile devices or laptops, and without additional software.
- Sophisticated data recording via the data logger allows for long-term analyses in high resolution and can also be used for statistical data analysis and fault prognosis.

Areas of application	Key areas	Conformity / Standards
<ul style="list-style-type: none"> • Industry • Infrastructure • Testing devices • Service sector • Public sector 	<ul style="list-style-type: none"> • Modular measurement for multiple outlets • Accuracy class 0.1 for electricity and 0.05 for voltage in accordance with IEC61557-12 • High flexibility and intuitive operation • Plug and Play • PQ functionality in accordance with IEC61000-4-30 • Flickermeter in accordance with IEC61000-4-15 • Records harmonics in current and voltage • Highly precise measurements in the additional frequency range 	<ul style="list-style-type: none"> • IEC61557-12 • IEC61000-4-15 • IEC61000-4-30 • ISO 14025

Discovery Tool

The MRE is configured with a preset IP address upon delivery. With the free discovery tool, the device can easily be located from any computer in all networks. No special knowledge is required, nor is it necessary to modify the communication parameters of your own computer. Whether you are using a fixed IP address or DHCP, the discovery tool allows the basic settings of the MRE's communication interface to be configured as required.

Web server

The integrated web server provides a clear interface for configuring the MRE for each individual application. In just a few clicks, the MRE can be configured for the circuit to be measured. The integrated search function allows the desired parameters to be found quickly. Important variables can be added to a favourites list and displayed graphically. Two access levels protect the device from unauthorised access and ensure a high degree of security.

Flexible

- Simplified wiring with PoE
- Measurements close to load (transformer and meter)
- Data logging and customised dashboards via optional data logger
- Full PQ functionality and individual protective functions can be optionally integrated
- Transformers of various accuracy grades available as accessories

Power supply	
Nominal voltage	24 V DC
Operating voltage range	18 ... 30 V DC
Power consumption AC/DC	- / 5 W

Measuring circuit	
Measured parameters	U, I, f, P, Q, S, E, THDU, THDI
Number of voltage measurement inputs	4
Rated AC voltage L-N / L-L	230 V AC / 400 V AC
AC voltage measurement range L-N / L-L	5 ... 276 V AC / 5 ... 480 V AC
Number of current measurement inputs	4
Rated measurement current	5 A
Measurement current range	0.005 ... 6 A
Max. current	60 A, 1 s
Rated base frequency	30 ... 65 Hz
Harmonic frequency	< 10 kHz
Sampling frequency per measurement channel	20 kS / s
Bandwidth per measurement channel	10 kHz
Accuracy class voltage [U]	0.05
Accuracy class current [I]	0.5
Accuracy class frequency [f]	0.02
Accuracy class power factor [cosPhi]	0.5
Accuracy class active power [P]	0.1
Accuracy class active energy [E]	0.2
Accuracy class reactive power [Q]	1
Accuracy class apparent power [S]	0.2
THDU / THDI	1 / 1

Inputs	
Number of analogue / digital inputs	3
Nominal voltage digital inputs	24 V DC
High level threshold digital Inputs	11.5 V DC
Nominal range analogue inputs	0 ... 10 V
Resolution of analogue inputs	12 Bit

Outputs	
Number of transistor outputs	1
Rated voltage	60 V DC
Rated current	350 mA

Interfaces	
Hardware interfaces	Ethernet, RS 485
Protocols	Modbus TCP, Modbus RTU
Transfer rate	100 Mbit, 19200 Baud

Insulation	
Rated insulation voltage	300 V
Pollution degree	2
Overvoltage category	III

General data	
Ambient temperature storage	-40 ... 85 °C
Ambient temperature operation	-25 ... 55 °C
Conductor cross section	2.5 mm ²
Nominal screw torque	0.5 Nm
Module width	fig. 2
Weight	120 g
Protection degree	IP 20
Housing material	PC

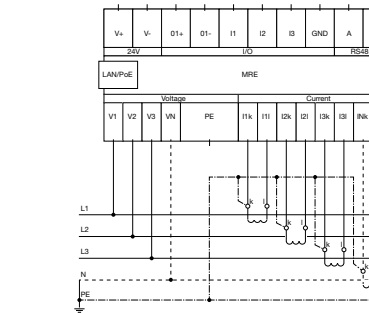
Product references

Types	Product reference	24
Energy measuring	MRE-44S/DC...V	✓

"..." list control circuit voltage to complete product references.
Other voltages on request. Please contact support@comatreleco.com.

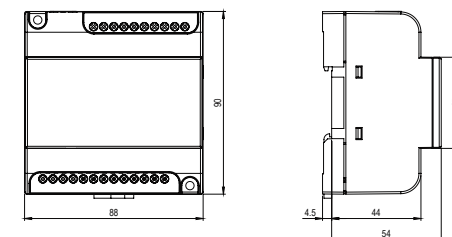


fig. 1. Wiring diagram



Connection diagrams for other networks in the technical data sheet.

fig. 2. Dimensions (mm)

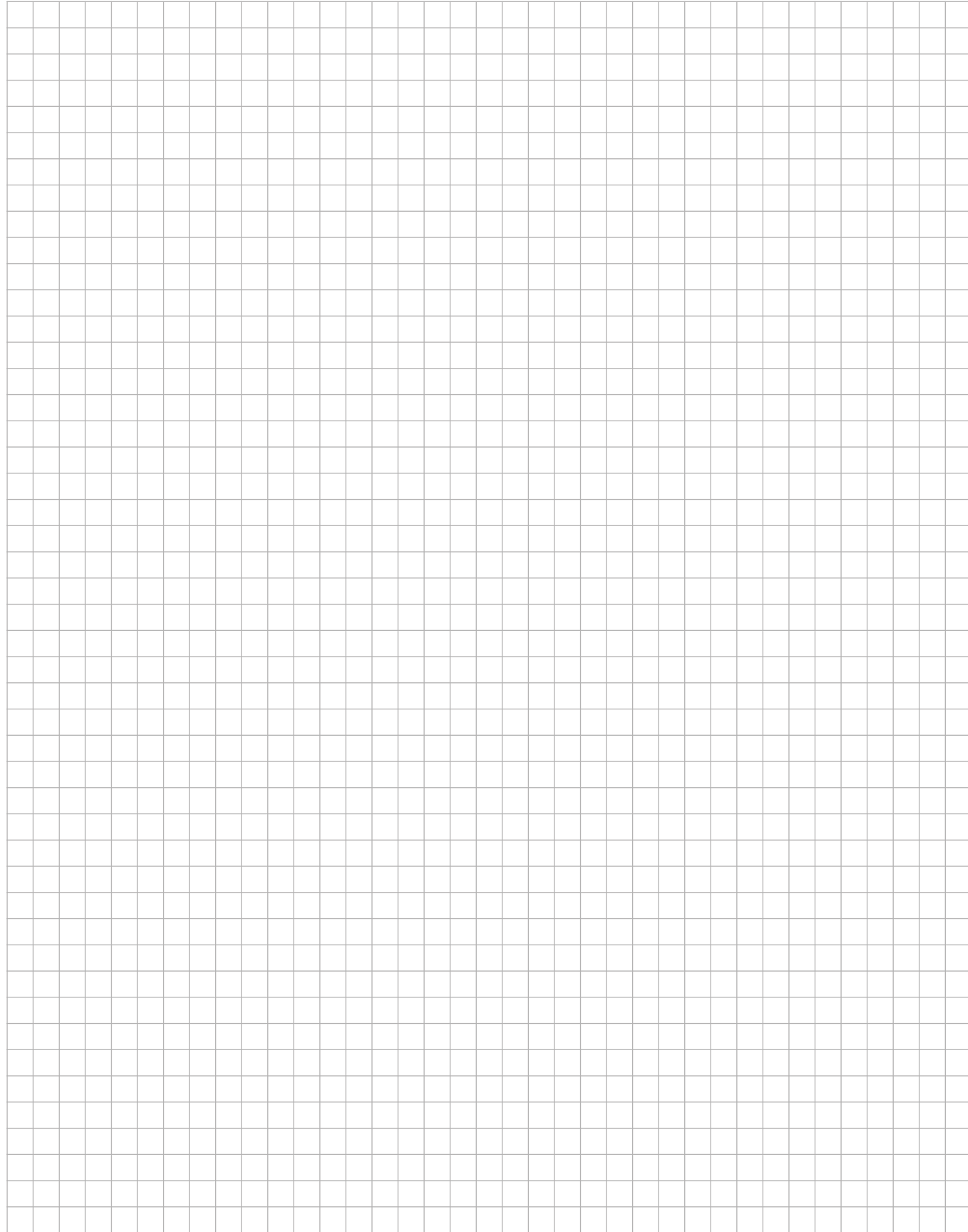


Standards and approvals

Standards IEC/EN 61000-6-2:2005, IEC/EN 61000-6-3:2007, IEC/EN 61557-12, IEC/EN 61000-4-15, IEC/EN 61000-4-30

Approvals

Notes



3.2 Multifunction Monitoring

Application	Type	Page
MRM Series		
Single phase multifunction monitoring 12 ... 48 V UC 110 ... 240 V UC	MRM11, MRM11R	230
Three phase multifunction monitoring 12 ... 48 V UC 110 ... 240 V UC	MRM32, MRM32R	231

3.2 Multifunction Monitoring

MRM11, MRM11R

Single phase multifunction monitoring | 12 ... 48 V UC | 110 ... 240 V UC

Power supply	12 ... 48 V UC	110 ... 240 V UC
Nominal voltage	12 ... 48 V UC	110 ... 240 V UC
Operating voltage range	10 ... 60 V	85 ... 250 V
Power consumption AC/DC	3.2 VA / 1.6 W	2.6 VA / 1.5 W
Rated frequency	16 ... 63 Hz	

Measuring circuit	U, I, P, S, f, Cosφ
Measured parameters	U, I, P, S, f, Cosφ
Min. setting step, resolution	0.1 V / 0.1 A / 1 W / 1 VA / 0.1 Hz / 0.01
Monitoring functions	Under, over, inside, outside
Number of voltage measurement inputs	1
Rated AC voltage L-N / L-L	230 V / -
AC voltage measurement range L-N / L-L	0.1 ... 480 V
Rated DC voltage U+-U-	300 V
DC voltage measurement range U+-U-	±0.1 ... 690 V
Undervoltage setting range	0.1 ... 480 V AC / ±0.1 ... 690 V DC
Overvoltage setting range	0.1 ... 480 V AC / ±0.1 ... 690 V DC
Number of current measurement inputs	1
Rated measurement current	5 A
Measurement current range	0.1 ... 6 A
Undercurrent setting range	0.1 ... 5 A
Overcurrent setting range	0.1 ... 5 A
Rated base frequency	15 ... 150 Hz
Alarm delay	0.5 ... 999.9 s
Alarm reset delay	0.5 ... 999.9 s

Main circuit	1 CO
Number of contacts	1 CO
Contact Material	AgNi
Rated voltage	250 V
Rated current	6 A
Minimum load	10 mA, 10 V
Inrush current	10 A, 10 ms
Rated load DC	fig. 2
Rated load AC-1	1500 VA
Mechanical endurance (cycles)	3 x 10 ⁷
Electrical endurance at rated load AC-1 (cycles)	fig. 3

Insulation	1.5 kV rms / 1 min
Rated test voltage measuring / measuring circuit	1.5 kV rms / 1 min
Rated test voltage measuring circuit / power supply	2 kV rms / 1 min
Rated test voltage measuring circuit / main circuit	2 kV rms / 1 min
Rated test voltage main circuit / power supply	2 kV rms / 1 min
Rated test voltage open contact	1 kV rms / 1 min
Pollution degree	2
Overvoltage category	III

General data	-40 ... 85 °C
Ambient temperature storage	-40 ... 85 °C
Ambient temperature operation	-40 ... 60 °C
Ambient temperature operation railway version	-40 ... 70 °C
Conductor cross section	2.5 mm ²
Nominal screw torque	0.6 Nm
Module width	fig. 4
Weight	107 g
Protection degree	IP 20
Housing material	PC

Product references	12-48	110-240
Types	Product reference	12-48 110-240
Single phase monitoring	MRM11/UC...V	✓ ✓
Single phase monitoring, railway version	MRM11R/UC...V	✓ ✓

"..." list control circuit voltage to complete product references.
Other voltages on request. Please contact support@comatreleco.com.



fig. 1. Wiring diagram

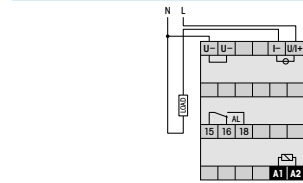


fig. 2. DC load limit curve

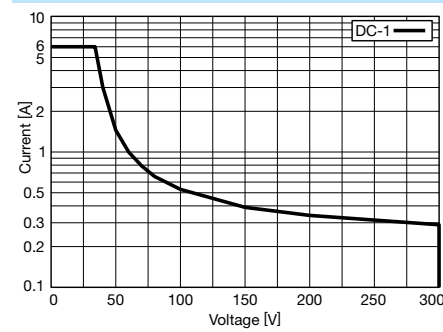


fig. 3. AC voltage endurance

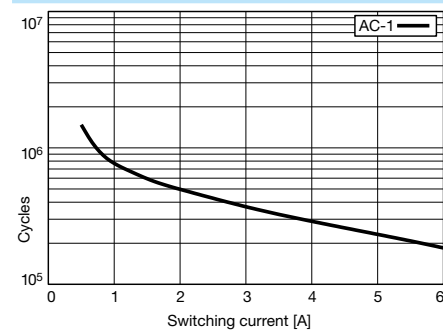
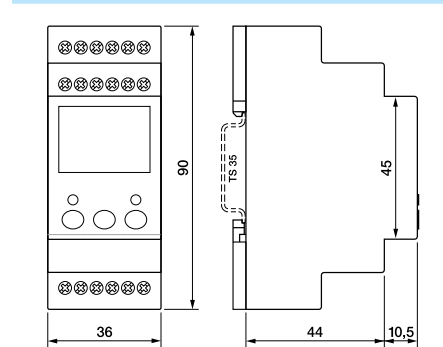


fig. 4. Dimensions (mm)



Standards and approvals

Standards IEC/EN 60947, IEC/EN 60730, IEC/EN 50155, IEC/EN 45545, IEC/EN 43880



3.2 Multifunction Monitoring

MRM32, MRM32R

Three phase multifunction monitoring | 12 ... 48 V UC | 110 ... 240 V UC

Power supply	12 ... 48 V UC	110 ... 240 V UC
Nominal voltage	12 ... 48 V UC	110 ... 240 V UC
Operating voltage range	10 ... 60 V	85 ... 250 V
Power consumption AC/DC	3.2 VA / 1.6 W	2.6 VA / 1.5 W
Rated frequency	16 ... 63 Hz	

Measuring circuit	U, I, P, S, f, Cosφ, ΔPhi, phase sequence
Measured parameters	U, I, P, S, f, Cosφ, ΔPhi, phase sequence
Min. setting step, resolution	0.1 V / 0.1 A / 1 W / 1 VA / 0.1 Hz / 0.01 / 1°
Monitoring functions	Under, over, inside, outside, phase sequence, phase failure
Number of voltage measurement inputs	3
Rated AC voltage L-N / L-L	230 V / 400 V
AC voltage measurement range L-N / L-L	0.1 ... 480 V
Rated DC voltage U+-U-	300 V
DC voltage measurement range U+-U-	±0.1 ... 690 V
Undervoltage setting range	0.1 ... 480 V AC / ±0.1 ... 690 V DC
Overvoltage setting range	0.1 ... 480 V AC / ±0.1 ... 690 V DC
Number of current measurement inputs	3
Rated measurement current	5 A
Measurement current range	0.1 ... 6 A
Undercurrent setting range	0.1 ... 5 A
Overcurrent setting range	0.1 ... 5 A
Rated base frequency	15 ... 150 Hz
Alarm delay	0.5 ... 999.9 s
Alarm reset delay	0.5 ... 999.9 s

Main circuit	2 CO
Number of contacts	2 CO
Contact Material	AgNi
Rated voltage	250 V
Rated current	6 A
Minimum load	10 mA, 10 V
Inrush current	10 A, 10 ms
Rated load DC	fig. 2
Rated load AC-1	1500 VA
Mechanical endurance (cycles)	3 x 10 ⁷
Electrical endurance at rated load AC-1 (cycles)	fig. 3

Insulation	1.5 kV rms / 1 min
Rated test voltage measuring / measuring circuit	1.5 kV rms / 1 min
Rated test voltage measuring circuit / power supply	2 kV rms / 1 min
Rated test voltage measuring circuit / main circuit	2 kV rms / 1 min
Rated test voltage main circuit / power supply	2 kV rms / 1 min
Rated test voltage main / main circuit	1.5 kV rms / 1 min
Rated test voltage open contact	1 kV rms / 1 min
Pollution degree	2
Overvoltage category	III

General data	-40 ... 85 °C
Ambient temperature storage	-40 ... 85 °C
Ambient temperature operation	-40 ... 60 °C
Ambient temperature operation railway version	-40 ... 70 °C
Conductor cross section	2.5 mm ²
Nominal screw torque	0.6 Nm
Module width	fig. 4
Weight	125 g
Protection degree	IP 20
Housing material	PC

Product references	12-48	110-240
Types	Product reference	12-48 110-240
Three phase monitoring	MRM32/UC...V	✓ ✓
Three phase monitoring, railway version	MRM32R/UC...V	✓ ✓

"..." list control circuit voltage to complete product references.
Other voltages on request. Please contact support@comatreleco.com.

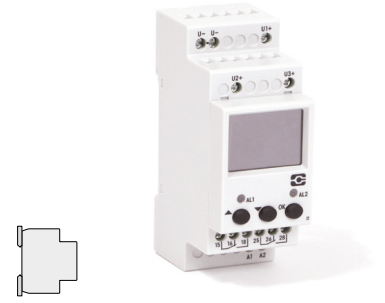


fig. 1. Wiring diagram

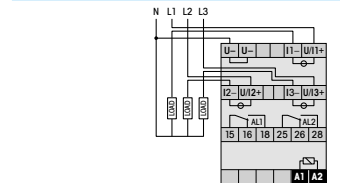


fig. 2. DC load limit curve

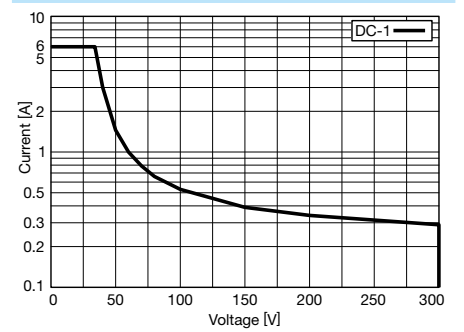


fig. 3. AC voltage endurance

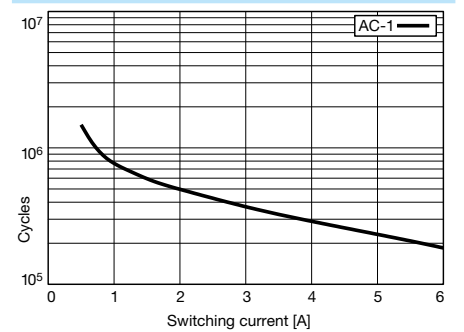
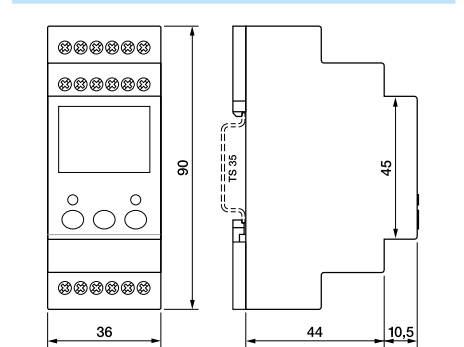


fig. 4. Dimensions (mm)



Standards and approvals

Standards IEC/EN 60947, IEC/EN 60730, IEC/EN 50155, IEC/EN 45545, IEC/EN 43880



Approvals

MRU11

Single phase voltage monitoring | 12 ... 48 V UC | 110 ... 240 V UC

Power supply		
Nominal voltage	12 ... 48 V UC	110 ... 240 V UC
Operating voltage range	10 ... 60 V	85 ... 250 V
Power consumption AC/DC	3.2 VA / 1.6 W	2.6 VA / 1.5 W
Rated frequency	16 ... 63 Hz	

Measuring circuit		
Measured parameters	U, f	
Min. setting step, resolution	0.1 V / 0.1 Hz	
Monitoring functions	Under, over, inside, outside	
Number of voltage measurement inputs	1	
Rated AC voltage L-N / L-L	230 V / -	
AC voltage measurement range L-N / L-L	0.1 ... 480 V	
Rated DC voltage U+-U-	300 V	
DC voltage measurement range U+-U-	±0.1 ... 690 V	
Undervoltage setting range	0.1 ... 480 V AC / ±0.1 ... 690 V DC	
Oversvoltage setting range	0.1 ... 480 V AC / ±0.1 ... 690 V DC	
Alarm delay	0.5 ... 999.9 s	
Alarm reset delay	0.5 ... 999.9 s	

Main circuit		
Number of contacts	1 CO	
Contact Material	AgNi	
Rated voltage	250 V	
Rated current	6 A	
Minimum load	10 mA, 10 V	
Inrush current	10 A, 10 ms	
Rated load DC	fig. 2	
Rated load AC-1	1500 VA	
Mechanical endurance (cycles)	3 x 10 ⁷	
Electrical endurance at rated load AC-1 (cycles)	fig. 3	

Insulation		
Rated test voltage measuring / measuring circuit	1.5 kV rms / 1 min	
Rated test voltage measuring circuit / power supply	2 kV rms / 1 min	
Rated test voltage measuring circuit / main circuit	2 kV rms / 1 min	
Rated test voltage main circuit / power supply	2 kV rms / 1 min	
Rated test voltage open contact	1 kV rms / 1 min	
Pollution degree	2	
Oversvoltage category	III	

General data		
Ambient temperature storage	-40 ... 85 °C	
Ambient temperature operation	-40 ... 60 °C	
Conductor cross section	2.5 mm ²	
Nominal screw torque	0.6 Nm	
Module width	fig. 4	
Weight	107 g	
Protection degree	IP 20	
Housing material	PC	

Product references			
Types	Product reference	12-48	110-240
Single phase monitoring	MRU11/UC...V	✓	✓

"..." list control circuit voltage to complete product references.
Other voltages on request. Please contact support@comatreleco.com.



fig. 1. Wiring diagram

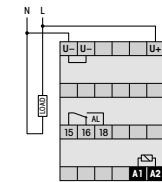


fig. 2. DC load limit curve

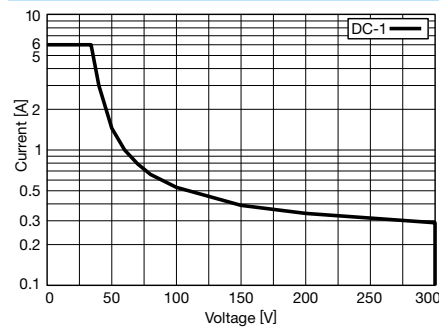


fig. 3. AC voltage endurance

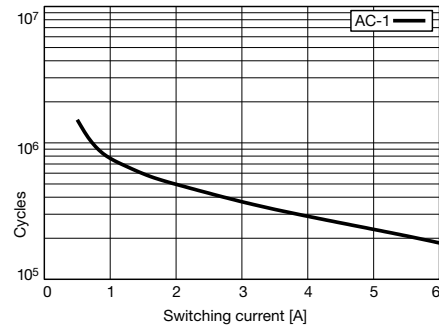
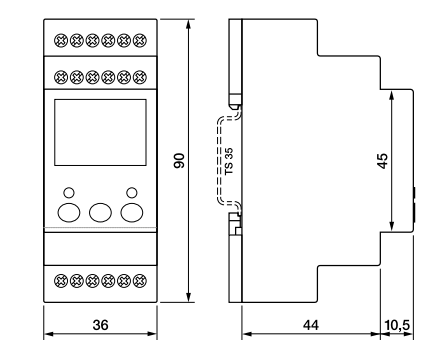


fig. 4. Dimensions (mm)



Standards and approvals

Standards IEC/EN 60947, IEC/EN 60730, IEC/EN 43880



MRU32

Three phase voltage monitoring | 12 ... 48 V UC | 110 ... 240 V UC

Power supply		
Nominal voltage	12 ... 48 V UC	110 ... 240 V UC
Operating voltage range	10 ... 60 V	85 ... 250 V
Power consumption AC/DC	3.2 VA / 1.6 W	2.6 VA / 1.5 W
Rated frequency	16 ... 63 Hz	

Measuring circuit		
Measured parameters	U, f, ΔPhi, phase sequence	
Min. setting step, resolution	0.1 V / 0.1 Hz / 0.01	
Monitoring functions	Under, over, inside, outside, phase sequence, phase failure	
Number of voltage measurement inputs	3	
Rated AC voltage L-N / L-L	230 V / 400 V	
AC voltage measurement range L-N / L-L	0.1 ... 480 V	
Rated DC voltage U+-U-	300 V	
DC voltage measurement range U+-U-	±0.1 ... 690 V	
Undervoltage setting range	0.1 ... 480 V AC / ±0.1 ... 690 V DC	
Oversvoltage setting range	0.1 ... 480 V AC / ±0.1 ... 690 V DC	
Alarm delay	0.5 ... 999.9 s	
Alarm reset delay	0.5 ... 999.9 s	

Main circuit		
Number of contacts	2 CO	
Contact Material	AgNi	
Rated voltage	250 V	
Rated current	6 A	
Minimum load	10 mA, 10 V	
Inrush current	10 A, 10 ms	
Rated load DC	fig. 2	
Rated load AC-1	1500 VA	
Mechanical endurance (cycles)	3 x 10 ⁷	
Electrical endurance at rated load AC-1 (cycles)	fig. 3	

Insulation		
Rated test voltage measuring / measuring circuit	1.5 kV rms / 1 min	
Rated test voltage measuring circuit / power supply	2 kV rms / 1 min	
Rated test voltage measuring circuit / main circuit	2 kV rms / 1 min	
Rated test voltage main circuit / power supply	2 kV rms / 1 min	
Rated test voltage main / main circuit	1.5 kV rms / 1 min	
Rated test voltage open contact	1 kV rms / 1 min	
Pollution degree	2	
Oversvoltage category	III	

General data		
Ambient temperature storage	-40 ... 85 °C	
Ambient temperature operation	-40 ... 60 °C	
Conductor cross section	2.5 mm ²	
Nominal screw torque	0.6 Nm	
Module width	fig. 4	
Weight	125 g	
Protection degree	IP 20	
Housing material	PC	

Product references			
Types	Product reference	12-48	110-240
Three phase monitoring	MRU32/UC...V	✓	✓

"..." list control circuit voltage to complete product references.
Other voltages on request. Please contact support@comatreleco.com.



fig. 1. Wiring diagram

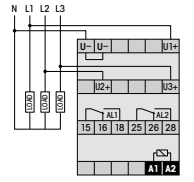


fig. 2. DC load limit curve

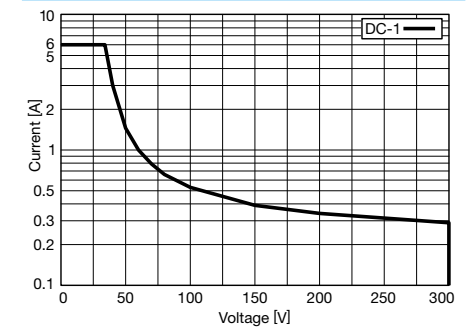


fig. 3. AC voltage endurance

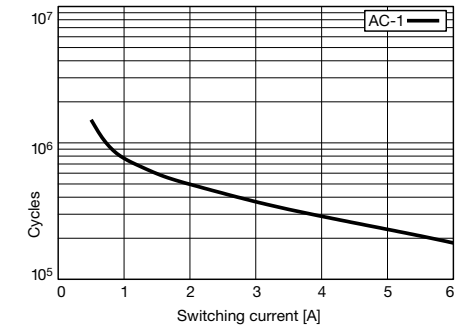
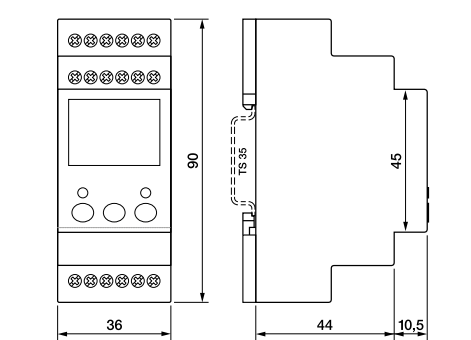


fig. 4. Dimensions (mm)



Standards and approvals

Standards IEC/EN 60947, IEC/EN 60730, IEC/EN 43880



MV53

Single phase voltage monitoring | 115 V AC | 230 V AC

Power supply	
Nominal voltage	230 V AC
Operating voltage range	149 ... 270 V
Power consumption AC/DC	2.3 VA / -
Rated frequency	45 ... 65 Hz

Measuring circuit	
Measured parameters	U
Monitoring functions	Under, over
Number of voltage measurement inputs	1 (A1 / A2)
Rated AC voltage L-N / L-L	230 V / -
AC voltage measurement range L-N / L-L	149 ... 270 V
Undervoltage setting range	149 ... 218 V
Overvoltage setting range	236 ... 270 V
Rated base frequency	45 ... 65 Hz

Main circuit	
Number of contacts	1 CO
Contact Material	AgNi
Rated voltage	250 V
Rated current	6 A
Minimum load	10 mA, 5 V
Inrush current	20 A, 20 ms
Rated load DC	fig. 2
Rated load AC-1	1500 VA
Mechanical endurance (cycles)	2 x 10 ⁷
Electrical endurance at rated load AC-1 (cycles)	fig. 3

Insulation	
Rated test voltage main circuit / power supply	2 kV rms / 1 min
Rated test voltage open contact	1 kV rms / 1 min
Pollution degree	2
Overvoltage category	III

General data	
Ambient temperature storage	-40 ... 85 °C
Ambient temperature operation	-40 ... 60 °C
Conductor cross section	2.5 mm ² , 2 x 1.5 mm ²
Nominal screw torque	0.8 Nm
Module width	fig. 4
Weight	80 g
Protection degree	IP 20
Housing material	PC

Product references		
Types	Product reference	230
Single phase monitoring	MV53/AC...V	✓

"..." list control circuit voltage to complete product references.
Other voltages on request. Please contact support@comatreleco.com.



fig. 1. Wiring diagram

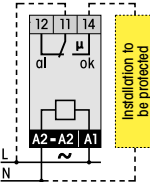


fig. 2. DC load limit curve

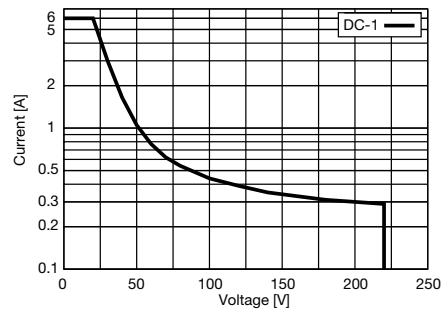


fig. 3. AC voltage endurance

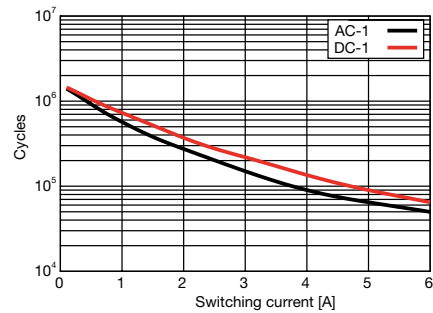
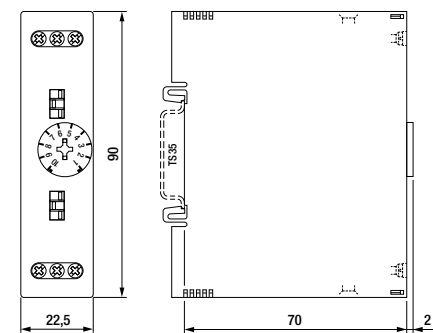


fig. 4. Dimensions (mm)



Standards and approvals

Standards IEC/EN 60065



SSU34

Three phase + N voltage monitoring | 400 V AC

Power supply	
Nominal voltage	400 V AC
Operating voltage range	240 ... 495 V
Power consumption AC/DC	1.5 VA
Rated frequency	50 Hz

Measuring circuit	
Measured parameters	U, ΔPhi, Δf
Monitoring functions	Under, over, phase failure, phase sequence
Number of voltage measurement inputs	4 (L1 / L2 / L3 / N)
Rated AC voltage L-N / L-L	230 V / 400 V
AC voltage measurement range L-N / L-L	160 ... 275 V / 280 ... 480 V
Undervoltage setting range	160 ... 225 V / 280 ... 390 V
Overvoltage setting range	235 ... 275 V / 410 ... 480 V
Voltage difference setting range L-L	20 ... 100 V 35 ... 173 V
Rated base frequency	50 Hz
Frequency difference setting range L-L	3 ... 15 Hz
Phase angle difference setting range L-L	3 ... 15°
Alarm delay	0.2 ... 5 s

Main circuit	
Number of contacts	2 CO
Contact Material	AgNi
Rated voltage	250 V
Rated current	5 A
Minimum load	10 mA, 12 V
Inrush current	15 A, 20 ms
Rated load DC	fig. 2
Rated load AC-1	1250 VA
Mechanical endurance (cycles)	5 x 10 ⁶
Electrical endurance at rated load AC-1 (cycles)	fig. 3

Insulation	
Rated test voltage measuring / measuring circuit	3 kV rms / 1 min
Rated test voltage measuring circuit / main circuit	3 kV rms / 1 min
Rated test voltage open contact	1 kV rms / 1 min
Pollution degree	2
Overvoltage category	III

General data	
Ambient temperature storage	-40 ... 85 °C
Ambient temperature operation	-10 ... 60 °C
Conductor cross section	2.5 mm ² , 2 x 1.5 mm ²
Nominal screw torque	0.5 Nm
Module width	fig. 4
Weight	350 g
Protection degree	IP 20
Housing material	PC

Product references		
Types	Product reference	400
Three phase monitoring	SSU34/AC...V	✓

"..." list control circuit voltage to complete product references.
Other voltages on request. Please contact support@comatreleco.com.



fig. 1. Wiring diagram

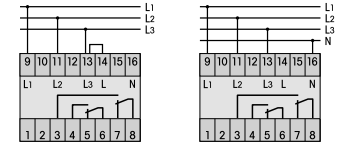


fig. 2. DC load limit curve

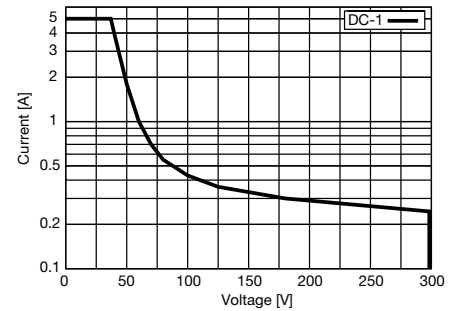


fig. 3. AC voltage endurance

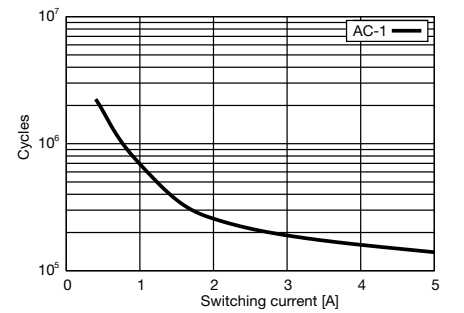
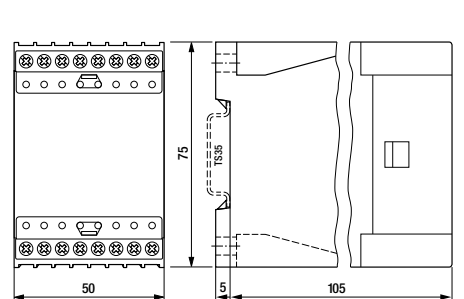


fig. 4. Dimensions (mm)



Standards and approvals

Standards IEC/EN 60947



SSU31

Phase sequence monitoring | 400 V AC

Power supply	
Nominal voltage	400 V AC
Operating voltage range	320 ... 480 V
Power consumption AC/DC	10 VA
Rated frequency	45 ... 65 Hz

Measuring circuit	
Measured parameters	U
Monitoring functions	Under, phase failure, phase sequence
Number of voltage measurement inputs	3 (L1 / L2 / L3)
Rated AC voltage L-N / L-L	- / 400 V
AC voltage measurement range L-N / L-L	320 ... 400 V
Undervoltage setting range	≤ 320 V
Rated base frequency	45 ... 65 Hz

Main circuit	
Number of contacts	1 CO
Contact Material	AgNi
Rated voltage	250 V
Rated current	6 A
Minimum load	10 mA, 5 V
Inrush current	15 A, 20 ms
Rated load DC	fig. 2
Rated load AC-1	1500 VA
Mechanical endurance (cycles)	3 x 10 ⁷
Electrical endurance at rated load AC-1 (cycles)	fig. 3

Insulation	
Rated test voltage measuring / measuring circuit	2 kV rms / 1 min
Rated test voltage measuring circuit / main circuit	2 kV rms / 1 min
Rated test voltage open contact	1 kV rms / 1 min
Pollution degree	2
Overtoltage category	III

General data	
Ambient temperature storage	-40 ... 85 °C
Ambient temperature operation	-25 ... 60 °C
Module width	fig. 4
Weight	300 g
Protection degree	IP 20
Housing material	PC

Product references		
Types	Product reference	400
Three phase monitoring	SSU31/AC...V	✓

"..." list control circuit voltage to complete product references.
Other voltages on request. Please contact support@comatreleco.com.

Accessories	
Socket	S3-M
Retaining clip	HF-24
Transparent front cover	FS-23
Front panel mounting set	FZ-23



fig. 1. Wiring diagram

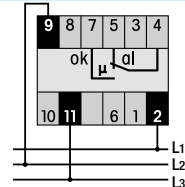


fig. 2. DC load limit curve

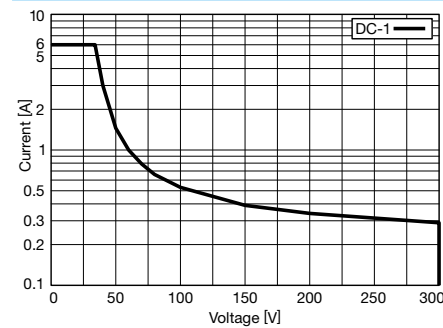


fig. 3. AC voltage endurance

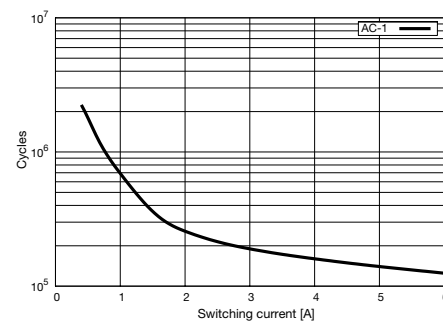
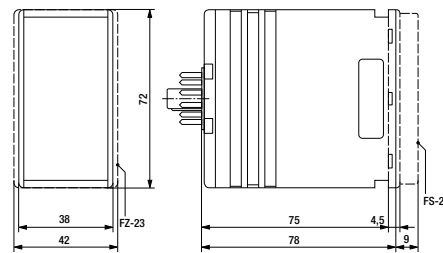


fig. 4. Dimensions (mm)



Standards and approvals

Standards IEC/EN 60947



SSU33L

Three phase + N voltage monitoring | 230 V AC | 400 V AC

Power supply		
Nominal voltage	230 V AC	400 V AC
Operating voltage range	160 ... 275 V	280 ... 480 V
Power consumption AC/DC	3 VA	
Rated frequency	50 Hz	

Measuring circuit		
Measured parameters	U, ΔPhi, Δf	
Monitoring functions	Under, over, phase failure, phase sequence	
Number of voltage measurement inputs	4 (L1 / L2 / L3 / N)	3 (L1 / L2 / L3)
Rated AC voltage L-N / L-L	230 V / 400 V	- / 400 V
AC voltage measurement range L-N / L-L	160 ... 275 V	280 ... 480 V
Undervoltage setting range	≤ 160 V	≤ 280 V
Overtoltage setting range	≥ 275 V	≥ 480 V
Voltage difference setting range L-L	20 ... 100 V	35 ... 173 V
Rated base frequency	50 Hz	
Frequency difference setting range L-L	3 ... 15 Hz	
Phase angle difference setting range L-L	3 ... 15°	
Alarm delay	0.2 ... 5 s	

Main circuit	
Number of contacts	1 CO
Contact Material	AgNi
Rated voltage	250 V
Rated current	6 A
Minimum load	10 mA, 5 V
Inrush current	15 A, 20 ms
Rated load DC	fig. 2
Rated load AC-1	1500 VA
Mechanical endurance (cycles)	3 x 10 ⁷
Electrical endurance at rated load AC-1 (cycles)	fig. 3

Insulation	
Rated test voltage measuring / measuring circuit	2 kV rms / 1 min
Rated test voltage measuring circuit / main circuit	2 kV rms / 1 min
Rated test voltage open contact	1 kV rms / 1 min
Pollution degree	2
Overtoltage category	III

General data	
Ambient temperature storage	-40 ... 85 °C
Ambient temperature operation	-25 ... 60 °C
Module width	fig. 4
Weight	300 g
Protection degree	IP 20
Housing material	PC

Product references			
Types	Product reference	230	400
Three phase monitoring	SSU33L/AC...V	✓	
Three phase monitoring + N	SSU33L/AC...V		✓

"..." list control circuit voltage to complete product references.
Other voltages on request. Please contact support@comatreleco.com.

Accessories	
Socket	S3-M
Retaining clip	HF-24
Transparent front cover	FS-23
Front panel mounting set	FZ-23



fig. 1. Wiring diagram

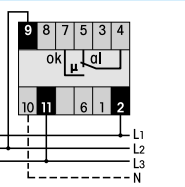


fig. 2. DC load limit curve

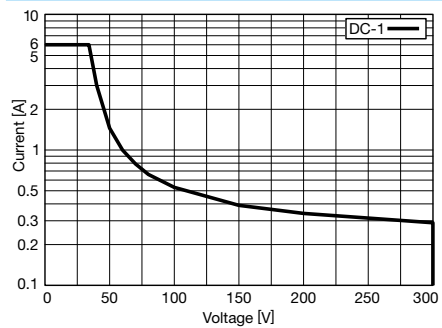


fig. 3. AC voltage endurance

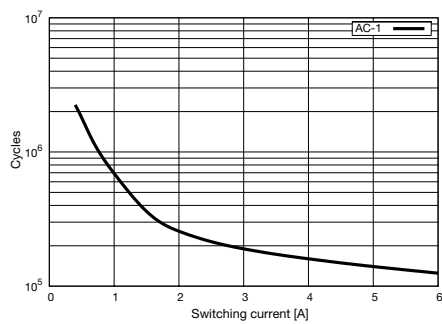
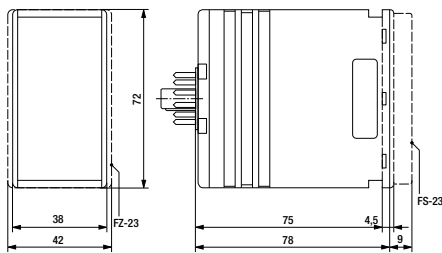


fig. 4. Dimensions (mm)



Standards and approvals

Standards IEC/EN 60947



Notes

Grid area for notes

3.5 Current Monitoring

Application	Type	Page
MRI Series		
Single phase current monitoring 12 ... 48 V UC 110 ... 240 V UC	MRI11	244
Three phase current monitoring 12 ... 48 V UC 110 ... 240 V UC	MRI32	245

MRI11

Single phase current monitoring | 12 ... 48 V UC | 110 ... 240 V UC

Power supply		
Nominal voltage	12 ... 48 V UC	110 ... 240 V UC
Operating voltage range	10 ... 60 V	85 ... 250 V
Power consumption AC/DC	3.2 VA / 1.6 W	2.6 VA / 1.5 W
Rated frequency	16 ... 63 Hz	

Measuring circuit	
Measured parameters	I, f
Min. setting step, resolution	0.1 A / 0.1 Hz
Monitoring functions	Under, over, inside, outside
Number of current measurement inputs	1
Rated measurement current	5 A
Measurement current range	0.1 ... 6 A
Undercurrent setting range	0.1 ... 5 A
Overcurrent setting range	0.1 ... 5 A
Rated base frequency	15 ... 150 Hz
Alarm delay	0.5 ... 999.9 s
Alarm reset delay	0.5 ... 999.9 s

Main circuit	
Number of contacts	1 CO
Contact Material	AgNi
Rated voltage	250 V
Rated current	6 A
Minimum load	10 mA, 10 V
Inrush current	10 A, 10 ms
Rated load DC	fig. 2
Rated load AC-1	1500 VA
Mechanical endurance (cycles)	3 x 10 ⁷
Electrical endurance at rated load AC-1 (cycles)	fig. 3

Insulation	
Rated test voltage measuring / measuring circuit	1.5 kV rms / 1 min
Rated test voltage measuring circuit / power supply	2 kV rms / 1 min
Rated test voltage measuring circuit / main circuit	2 kV rms / 1 min
Rated test voltage main circuit / power supply	2 kV rms / 1 min
Rated test voltage open contact	1 kV rms / 1 min
Pollution degree	2
Overvoltage category	III

General data	
Ambient temperature storage	-40 ... 85 °C
Ambient temperature operation	-40 ... 60 °C
Conductor cross section	2.5 mm ²
Nominal screw torque	0.6 Nm
Module width	fig. 4
Weight	107 g
Protection degree	IP 20
Housing material	PC

Product references			
Types	Product reference	12-48	110-240
Single phase monitoring	MRI11/UC...V	✓	✓

"..." list control circuit voltage to complete product references.
Other voltages on request. Please contact support@comatreleco.com.



fig. 1. Wiring diagram

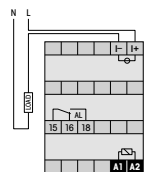


fig. 2. DC load limit curve

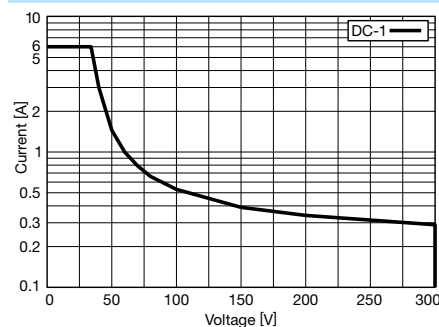


fig. 3. AC voltage endurance

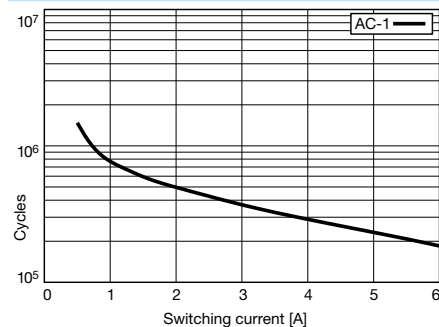
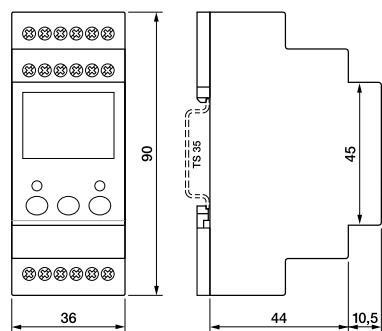


fig. 4. Dimensions (mm)



Standards and approvals

Standards IEC/EN 60947, IEC/EN 60730, IEC/EN 43880



MRI32

Three phase current monitoring | 12 ... 48 V UC | 110 ... 240 V UC

Power supply		
Nominal voltage	12 ... 48 V UC	110 ... 240 V UC
Operating voltage range	10 ... 60 V	85 ... 250 V
Power consumption AC/DC	3.2 VA / 1.6 W	2.6 VA / 1.5 W
Rated frequency	16 ... 63 Hz	

Measuring circuit	
Measured parameters	I, f
Min. setting step, resolution	0.1 A / 0.1 Hz
Monitoring functions	Under, over, inside, outside
Number of current measurement inputs	3
Rated measurement current	5 A
Measurement current range	0.1 ... 6 A
Undercurrent setting range	0.1 ... 5 A
Overcurrent setting range	0.1 ... 5 A
Rated base frequency	15 ... 150 Hz
Alarm delay	0.5 ... 999.9 s
Alarm reset delay	0.5 ... 999.9 s

Main circuit	
Number of contacts	2 CO
Contact Material	AgNi
Rated voltage	250 V
Rated current	6 A
Minimum load	10 mA, 10 V
Inrush current	10 A, 10 ms
Rated load DC	fig. 2
Rated load AC-1	1500 VA
Mechanical endurance (cycles)	3 x 10 ⁷
Electrical endurance at rated load AC-1 (cycles)	fig. 3

Insulation	
Rated test voltage measuring / measuring circuit	1.5 kV rms / 1 min
Rated test voltage measuring circuit / power supply	2 kV rms / 1 min
Rated test voltage measuring circuit / main circuit	2 kV rms / 1 min
Rated test voltage main circuit / power supply	2 kV rms / 1 min
Rated test voltage main / main circuit	1.5 kV rms / 1 min
Rated test voltage open contact	1 kV rms / 1 min
Pollution degree	2
Overvoltage category	III

General data	
Ambient temperature storage	-40 ... 85 °C
Ambient temperature operation	-40 ... 60 °C
Conductor cross section	2.5 mm ²
Nominal screw torque	0.6 Nm
Module width	fig. 4
Weight	125 g
Protection degree	IP 20
Housing material	PC

Product references			
Types	Product reference	12-48	110-240
Three phase monitoring	MRI32/UC...V	✓	✓

"..." list control circuit voltage to complete product references.
Other voltages on request. Please contact support@comatreleco.com.



fig. 1. Wiring diagram

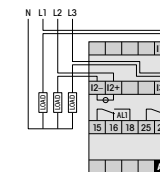


fig. 2. DC load limit curve

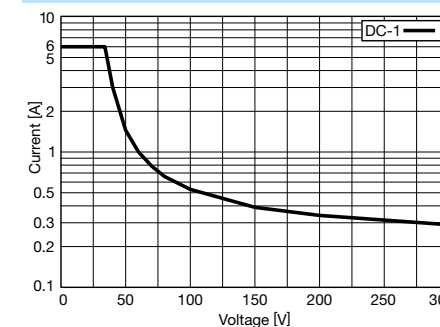


fig. 3. AC voltage endurance

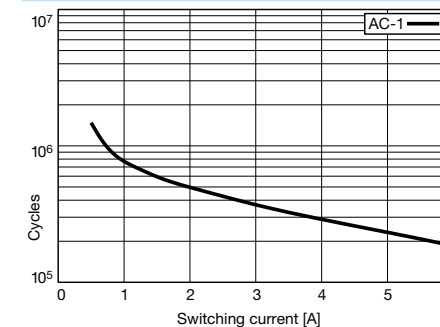
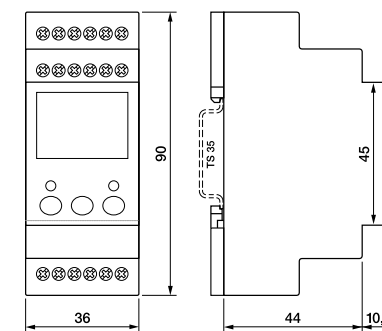
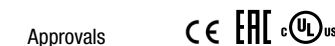


fig. 4. Dimensions (mm)



Standards and approvals

Standards IEC/EN 60947, IEC/EN 60730, IEC/EN 43880



TSR19

Motor protection | PTC | Clixon | 24 ... 48 V UC | 230 V AC

Power supply		
Nominal voltage	24 ... 48 V UC	230 V AC
Operating voltage range	0.85 ... 1.15 U _N	
Power consumption AC/DC	5 VA / 5 W	
Rated frequency	50 ... 60 Hz	

Measuring circuit	
Measured parameters	Ω
Monitoring functions	over, sensor ground fault, sensor break
Resistance, OK range	100 ... 1800 Ω
Clixon, OK range	0 ... 1800 Ω
Failure threshold	≤ 50 Ω, ≥ 2250 Ω, ≤ 1 kΩ (to ground)
Alarm delay	2.5 s

Main circuit	
Number of contacts	1 + 1 CO
Contact Material	AgNi
Rated voltage	250 V
Rated current	6 A
Minimum load	10 mA, 12 V
Rated load DC	fig. 2
Rated load AC-1	1250 VA
Mechanical endurance (cycles)	3 x 10 ⁷
Electrical endurance at rated load AC-1 (cycles)	fig. 3

Insulation	
Rated test voltage measuring circuit / power supply	2 kV rms / 1 min
Rated test voltage measuring circuit / main circuit	2 kV rms / 1 min
Rated test voltage main circuit / power supply	2 kV rms / 1 min
Rated test voltage main / main circuit	2 kV rms / 1 min
Rated test voltage open contact	1 kV rms / 1 min
Pollution degree	2
Overtoltage category	III

General data	
Ambient temperature storage	-40 ... 85 °C
Ambient temperature operation	-25 ... 60 °C
Module width	fig. 4
Weight	125 g
Protection degree	IP 20
Housing material	PC

Product references			
Types	Product reference	230	24-48
Motor protection, AC supply	TSR19/AC...V	✓	
Motor protection, UC supply	TSR19/UC...V		✓

"..." list control circuit voltage to complete product references.
Other voltages on request. Please contact support@comatreleco.com.

Accessories	
Socket	S3-M
Retaining clip	HF-24
Transparent front cover	FS-23
Front panel mounting set	FZ-23



fig. 1. Wiring diagram

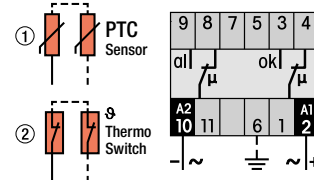


fig. 2. DC load limit curve

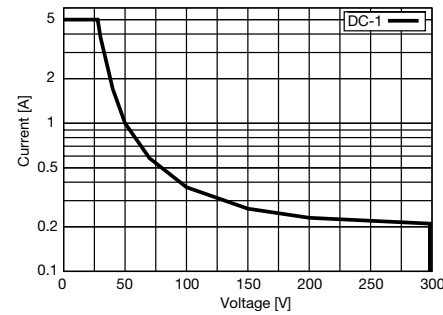


fig. 3. AC voltage endurance

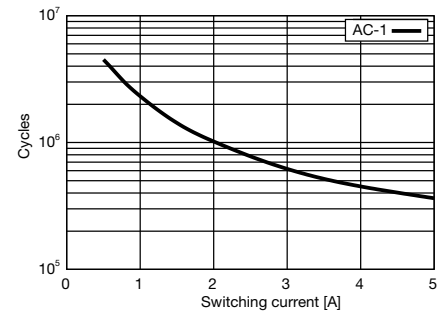
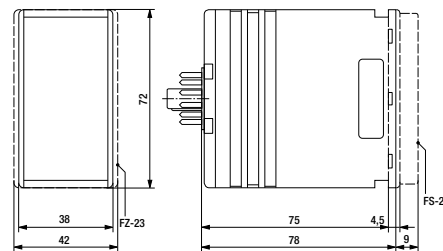


fig. 4. Dimensions (mm)



Standards and approvals

Standards IEC/EN 60947



3.7 Isolation Monitoring

Application	Type	Page
ESU Series		
DC Isolation monitoring 24 ... 48 V UC	ESU-D2R	250

ESU-D2R

DC Isolation monitoring | 24 ... 48 V UC

Power supply	
Nominal voltage	24 ... 48 V UC
Operating voltage range	18 ... 60 V
Power consumption AC/DC	2 VA / 2 W
Rated frequency	40 ... 60 Hz

Measuring circuit	
Measured parameters	Ω
Monitoring functions	under, ground fault
Rated DC voltage U+-U-	60 V
Overvoltage setting range	> 60 VDC
Circuit / ground resistance measurement range	1 ... 50 k Ω
Pre alarm setting range	4 ... 30 k Ω
Main alarm	≤ 4 k Ω
Alarm delay	0.1 ... 10 s

Main circuit	
Number of contacts	1 NO + 2 CO
Contact Material	AgNi
Rated voltage	250 V
Rated current	5 A
Minimum load	10 mA, 12 V
Rated load DC	fig. 2
Rated load AC-1	1250 VA
Mechanical endurance (cycles)	5×10^6
Electrical endurance at rated load AC-1 (cycles)	1×10^5

Insulation	
Pollution degree	2
Overvoltage category	III

General data	
Ambient temperature storage	-40 ... 85 °C
Ambient temperature operation railway version	-40 ... 70 °C
Conductor cross section	2.5 mm ² , 2 x 1.5 mm ²
Nominal screw torque	0.5 Nm
Module width	fig. 4
Weight	250 g
Protection degree	IP 20
Housing material	PC

Product references		
Types	Product reference	24-48
DC Isolation monitoring, railway version	ESU-D2R/UC...V	✓

"..." list control circuit voltage to complete product references.
Other voltages on request. Please contact support@comatreleco.com.



fig. 1. Wiring diagram

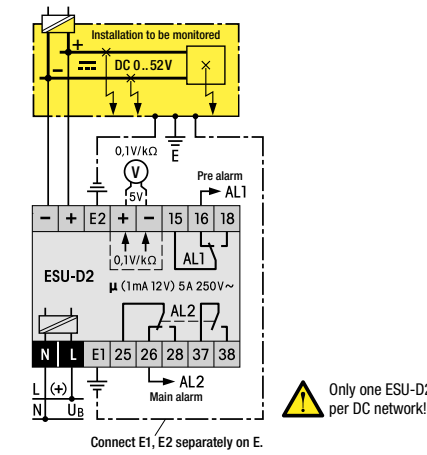


fig. 2. DC load limit curve

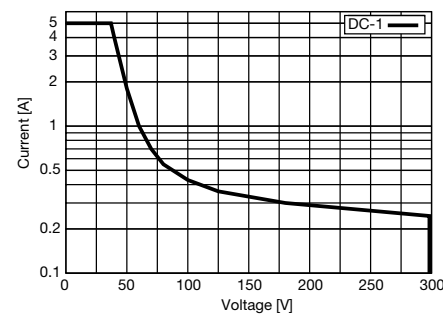
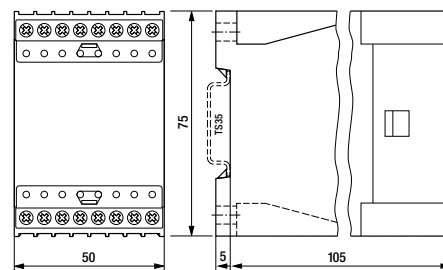


fig. 3. Dimensions (mm)



Standards and approvals

Standards IEC/EN 60947, IEC/EN 50155

Approvals

3.8 Monitoring Modules

Application	Type	Page
CT Series		
Current monitoring 36 V DC	CT515R	252
Voltage monitoring 24 V DC	CT524	253

CT515R

Current monitoring | 36 V DC

Power supply	
Nominal voltage	36 V DC
Operating voltage range	18 ... 45 V
Power consumption AC/DC	- / 2.3 V

Measuring circuit	
Measured parameters	I
Monitoring functions	Under, over, inside, outside
Rated measurement current	2 A
Measurement current range	0 ... 3 A
Undercurrent setting range	0 ... 2 A
Overcurrent setting range	0 ... 2 A
Alarm delay	100 ms / 500 ms / 2 s
Alarm reset delay	100 ms

General data	
Ambient temperature storage	-40 ... 85 °C
Ambient temperature operation railway version	-40 ... 70 °C
Module width	fig. 2
Weight	25 g
Protection degree	IP 20
Housing material	PC

Product references		
Types	Product reference	36
Current monitoring, railway version	CT515R/...V	✓

"..." list control circuit voltage to complete product references.
Other voltages on request. Please contact support@comatreleco.com.

Accessories	
Socket	S3-M0, S5-M



fig. 1. Wiring diagram

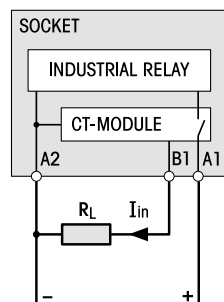
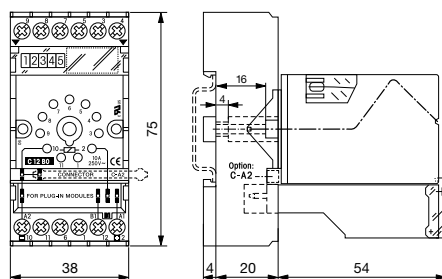


fig. 2. Dimensions (mm)



Standards and approvals

Standards IEC/EN 60947, IEC/EN 50155



CT524

Voltage monitoring | 24 V DC

Power supply	
Nominal voltage	24 V DC
Operating voltage range	18 ... 30 V
Power consumption AC/DC	- / 0.4 W

Measuring circuit	
Measured parameters	U
Monitoring functions	Under, over, inside, outside
DC voltage measurement range U+-U-	0 ... 30 V
Undervoltage setting range	0 ... 30 V
Overvoltage setting range	0 ... 30 V
Alarm delay	100 ms / 500 ms / 2 s
Alarm reset delay	100 ms

General data	
Ambient temperature storage	-40 ... 85 °C
Ambient temperature operation railway version	-40 ... 70 °C
Module width	fig. 2
Weight	25 g
Protection degree	IP 20
Housing material	PC

Product references		
Types	Product reference	24
Voltage monitoring, railway version	CT524R/...V	✓

"..." list control circuit voltage to complete product references.
Other voltages on request. Please contact support@comatreleco.com.

Accessories	
Socket	S3-M0, S5-M



fig. 1. Wiring diagram

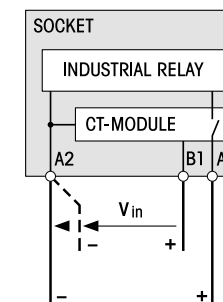
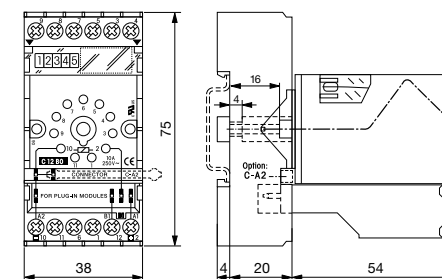


fig. 2. Dimensions (mm)



Standards and approvals

Standards IEC/EN 60947, IEC/EN 50155



CEM01

Suppressor device | 24 ... 240 V UC

Power supply	
Nominal voltage	24 ... 240 V UC
Operating voltage range	19 ... 250 V
Rated frequency	15 ... 63 Hz

General data	
Ambient temperature storage	-40 ... 85 °C
Ambient temperature operation	-25 ... 60 °C
Conductor cross section	0.08 ... 2.5 mm ²
Nominal screw torque	---
Module width	fig. 2
Weight	15 g
Protection degree	IP20
Housing material	PA 66

Product references		
Types	Product reference	24-240
Suppressor device	CEM01/UC...V	✓

"..." list control circuit voltage to complete product references.
Other voltages on request. Please contact support@comatreleco.com.



fig. 1. Wiring diagram

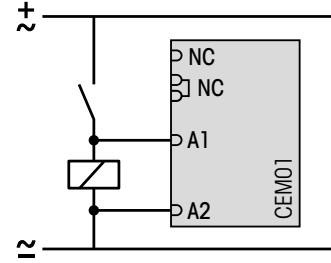
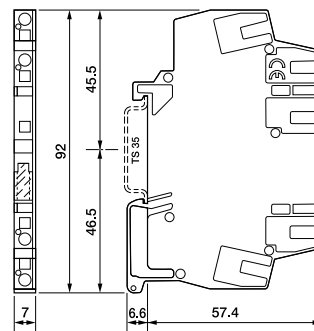


fig. 2. Dimensions (mm)



Standards and approvals

Standards

Approvals **CE**

CRC02

Overvoltage protection | 24 V UC

Power supply	
Nominal voltage	24 V UC
Operating voltage range	0 ... 30 V DC / 0 ... 38 V AC
Rated frequency	47 ... 63 Hz

General data	
Ambient temperature storage	-40 ... 85 °C
Ambient temperature operation	-25 ... 60 °C
Conductor cross section	2.5 mm ² , 2 x 1.5 mm ²
Nominal screw torque	0.4 N
Module width	fig. 2
Weight	70 g
Protection degree	IP20
Housing material	PC

Product references		
Types	Product reference	24
Overvoltage protection	CRC02/UC...V	✓

"..." list control circuit voltage to complete product references.
Other voltages on request. Please contact support@comatreleco.com.



fig. 1. Wiring diagram

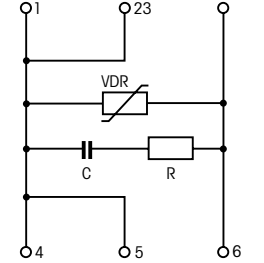
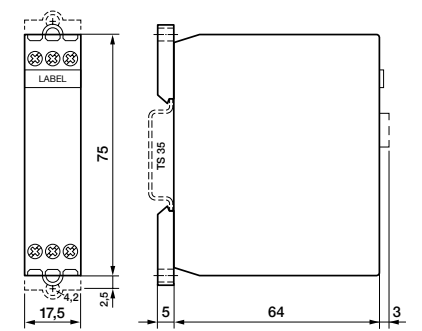


fig. 2. Dimensions (mm)

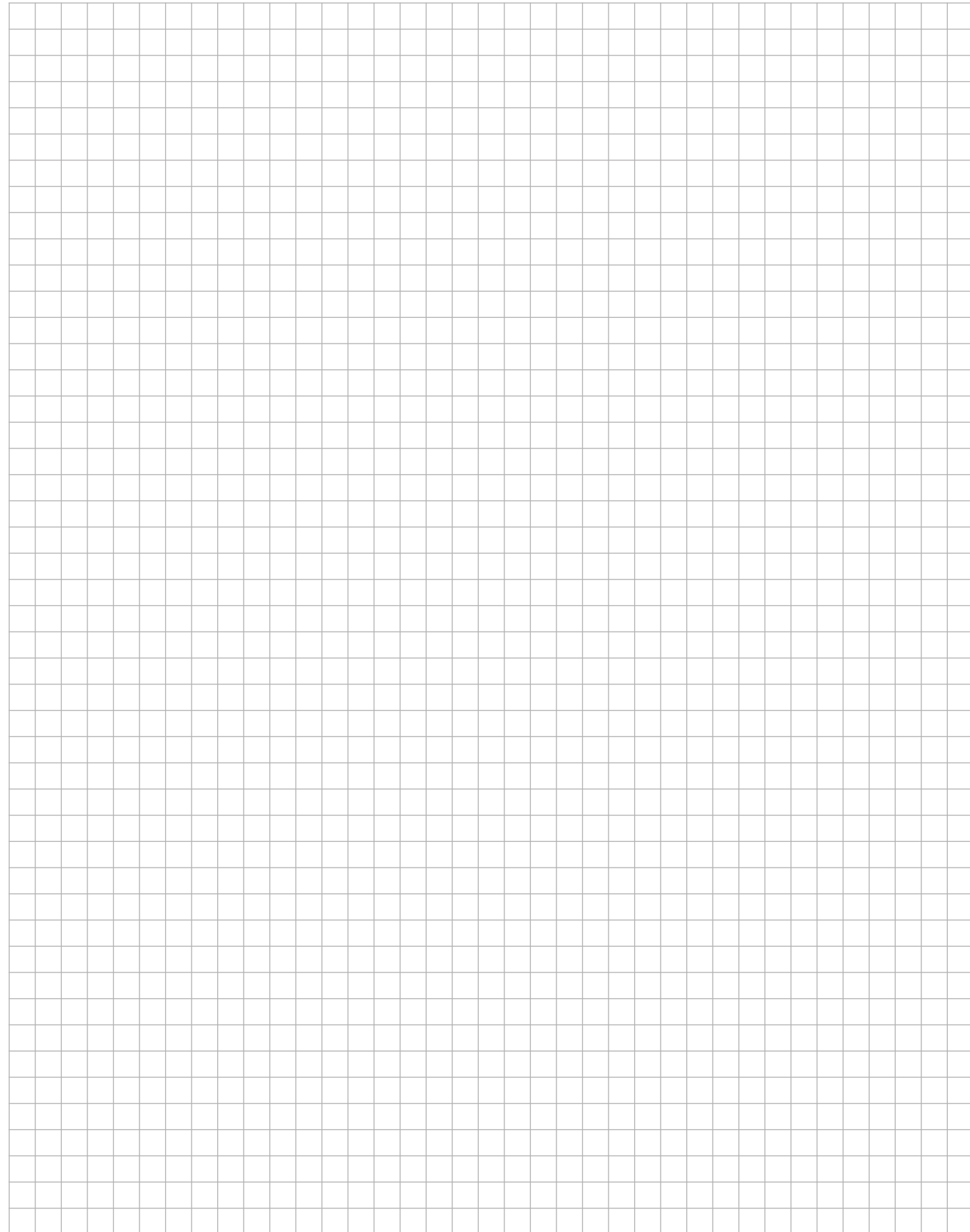


Standards and approvals

Standards

Approvals **CE**

Notes



3.10 Current Transmitter

Application	Type	Page
MRE-CT Series		
Current Transmitter 50 / 5 A ... 100 / 5 A	MRE-CT313	260
Current Transmitter 100 / 5 A ... 750 / 5 A	MRE-CT314	261
Current Transmitter 1000 / 5 A ... 1500 / 5 A	MRE-CT614	262
Current Transmitter 2000 / 5 A	MRE-CT1233	263

3.10 Current Transmitter

3

MRE-CT313

Current Transmitter | 50 / 5 A ... 100 / 5 A

Power supply	
Operating voltage range	< 720 V
Measuring circuit	
Power consumption at 5 A	0.36 VA/m (2.5 mm ² wire)
Measurement current range	≤ 1 x I _N
Max. current	60 x I _N , 1 s (max. 100 kA)
Rated base frequency	50 ... 60 Hz
Insulation	
Rated test voltage measuring / measuring circuit	3 kV rms / 1 min, U _m < 720 V
General data	
Ambient temperature storage	-25 ... 70 °C
Ambient temperature operation	-5 ... 50 °C
Module width	fig. 2
Weight	120 g
Protection degree	IP20

Product references

Types	Product reference	50	100
Class 1, power 1 VA	MRE-CT313-.../5A/1-1	✓	
Class 1, power 2.5 VA	MRE-CT313-.../5A/2.5-1		✓

"..." list primary current to complete product references.
Other transmission ratio on request. Please contact support@comatreleco.com.



fig. 1. Wiring diagram

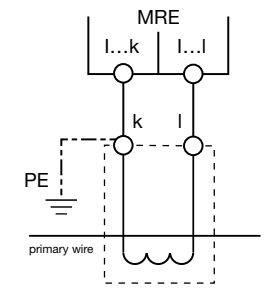
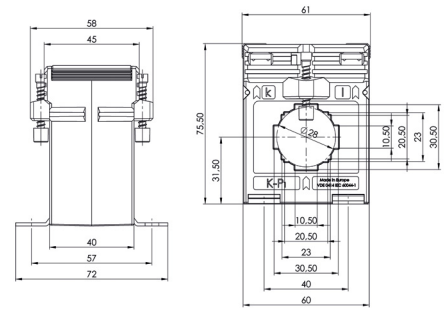


fig. 2. Dimensions (mm)



Standards and approvals

Standards IEC/EN 61869
Approvals CE

MRE-CT314

Current Transmitter | 100 / 5 A ... 750 / 5 A

Power supply	
Operating voltage range	< 720 V
Measuring circuit	
Power consumption at 5 A	0.36 VA/m (2.5 mm ² wire)
Measurement current range	≤ 1 x I _N
Max. current	60 x I _N , 1 s (max. 100 kA)
Rated base frequency	50 ... 60 Hz
Insulation	
Rated test voltage measuring / measuring circuit	3 kV rms / 1 min, U _m < 720 V
General data	
Ambient temperature storage	-25 ... 70 °C
Ambient temperature operation	-5 ... 50 °C
Module width	fig. 2
Weight	180 g
Protection degree	IP20

Product references

Types	Product reference	100	150	200	250	300	400	500	600	750
Class 0.2s, power 2.5 VA	MRE-CT314-.../5A/2.5-0.2S	✓	✓	✓						
Class 0.2s, power 5 VA	MRE-CT314-.../5A/5-0.2S					✓	✓	✓	✓	✓
Class 0.5, power 2.5 VA	MRE-CT314-.../5A/2.5-0.5	✓	✓	✓	✓					
Class 0.5, power 5 VA	MRE-CT314-.../5A/5-0.5					✓	✓	✓	✓	✓

"..." list primary current to complete product references.
Other transmission ratio on request. Please contact support@comatreleco.com.



fig. 1. Wiring diagram

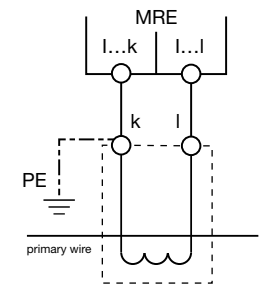
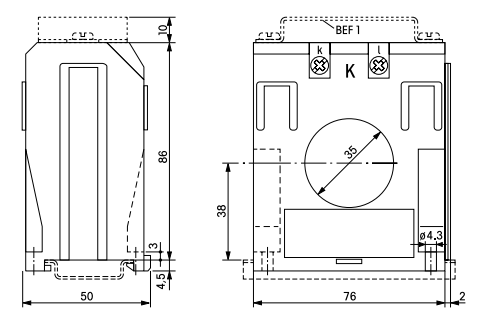


fig. 2. Dimensions (mm)



Standards and approvals

Standards IEC/EN 61869
Approvals CE

MRE-CT614

Current Transmitter | 1000 / 5 A ... 1500 / 5 A

Power supply	
Operating voltage range	< 720 V
Measuring circuit	
Power consumption at 5 A	0.36 VA/m (2.5 mm ² wire)
Measurement current range	≤ 1 x I _N
Max. current	60 x I _N , 1 s (max. 100 kA)
Rated base frequency	50 ... 60 Hz
Insulation	
Rated test voltage measuring / measuring circuit	3 kV rms / 1 min, U _m < 720 V
General data	
Ambient temperature storage	-25 ... 70 °C
Ambient temperature operation	-5 ... 50 °C
Module width	fig. 2
Weight	260 g
Protection degree	IP20

Product references

Types	Product reference	1000	1250	1500
Class 0.2s, power 10 VA	MRE-CT614-.../5A/10-0.2S	✓	✓	✓
Class 0.5, power 10 VA	MRE-CT614-.../5A/10-0.2S	✓	✓	✓

"..." list primary current to complete product references.
 Other transmission ratio on request. Please contact support@comatreleco.com.



fig. 1. Wiring diagram

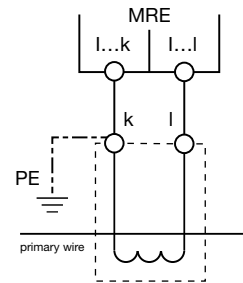
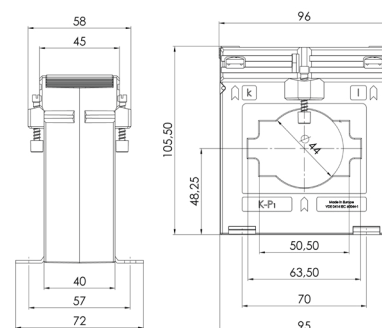


fig. 2. Dimensions (mm)



Standards and approvals

Standards IEC/EN 61869
 Approvals CE

MRE-CT1233

Current Transmitter | 2000 / 5 A

Power supply	
Operating voltage range	< 720 V
Measuring circuit	
Power consumption at 5 A	0.36 VA/m (2.5 mm ² wire)
Measurement current range	≤ 1 x I _N
Max. current	60 x I _N , 1 s (max. 100 kA)
Rated base frequency	50 ... 60 Hz
Insulation	
Rated test voltage measuring / measuring circuit	3 kV rms / 1 min, U _m < 720 V
General data	
Ambient temperature storage	-25 ... 70 °C
Ambient temperature operation	-5 ... 50 °C
Module width	fig. 2
Weight	340 g
Protection degree	IP20

Product references

Types	Product reference	2000
Class 0.2s, power 10 VA	MRE-CT1233-.../5A/10-0.2S	✓
Class 0.5, power 10 VA	MRE-CT1233-.../5A/10-0.2S	✓

"..." list primary current to complete product references.
 Other transmission ratio on request. Please contact support@comatreleco.com.



fig. 1. Wiring diagram

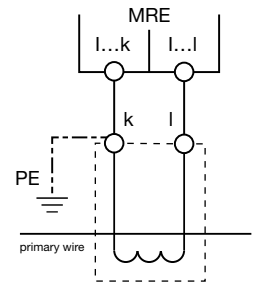
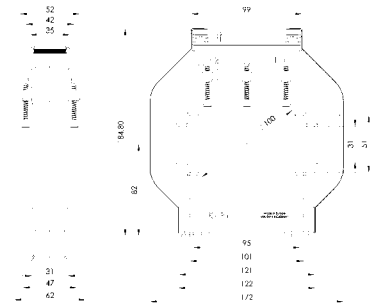


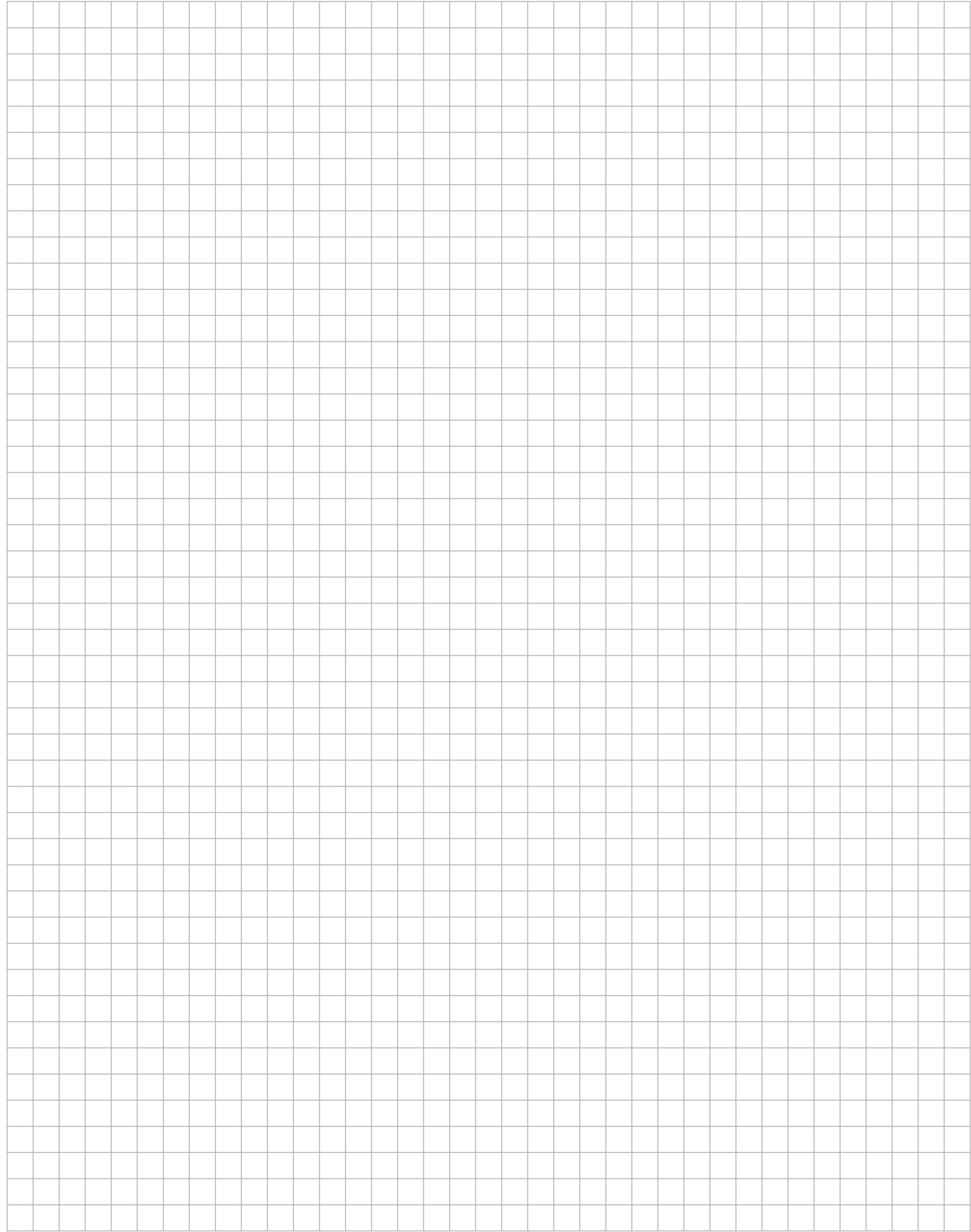
fig. 2. Dimensions (mm)



Standards and approvals

Standards IEC/EN 61869
 Approvals CE

Notes



3.11 **Monitoring Relay Accessories**

Application	Type	Page
Accessories		
Front panel mounting set Retaining clip	FZ-23	266
Transparent front cover	FS-23	267
Retaining clip Plastic	HF-24	268

3.11 Monitoring Relay Accessories

FZ-23

Front panel mounting set | Retaining clip

General data	
Ambient temperature storage	-40 ... 85 °C
Ambient temperature operation	-25 ... 60 °C
Module width	fig. 1
Weight	19 g

Product references	
Types	Product reference
Front panel mounting set	FZ-23

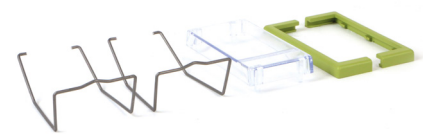
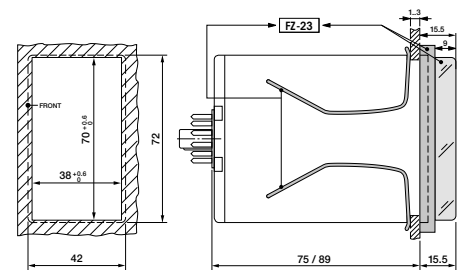


fig. 1. Dimensions (mm)



FS-23

Transparent front cover

General data	
Ambient temperature storage	-40 ... 85 °C
Ambient temperature operation	-25 ... 60 °C
Module width	fig. 1
Weight	80 g

Product references	
Types	Product reference
Transparent front cover	FS-23

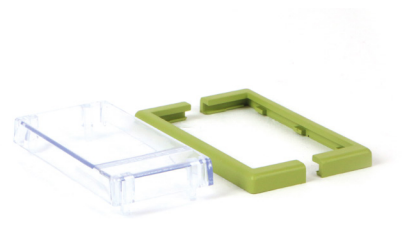
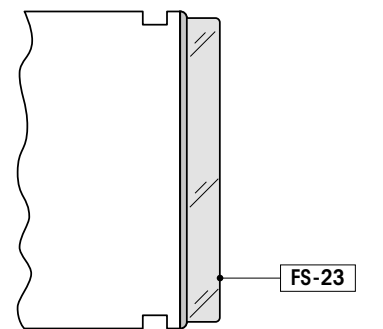


fig. 1. Dimensions (mm)

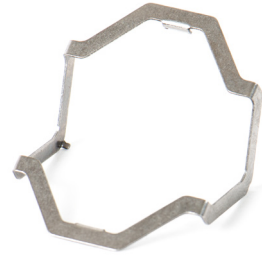


HF-24

Retaining clip | Plastic

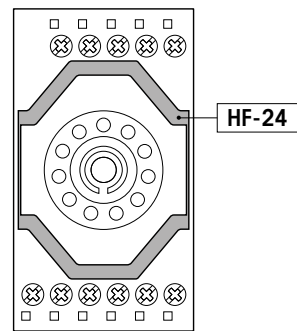
General data	
Ambient temperature storage	-40 ... 85 °C
Ambient temperature operation	-25 ... 60 °C
Module width	fig. 1
Weight	20 g
Housing material	PC

Product references	
Types	Product reference
Retaining clip	HF-24



4 **Sockets**

fig. 1. Dimensions (mm)





Socket Selection for industrial Relays																										
Socket Type	Description	C2	C3	C4	C5	C7	C9	C10	C12	C16PTL / C18PTL	C18-A15PT	C21	C22	C31	C32	R7	R-Module	C52 / C53 / C64	C55 / C56	C63 / C85	CT2	CT3	CT32 / CT33 / CT36	CT515 / CT524	KDM	
EC-11	Socket for industrial Relay		•											•	•											
S2-B	Socket for industrial Relay	•																				•				
S2-S *	Socket for industrial Relay	•										•	•									•				
S2-L *	Socket for industrial Relay	•																				•				
S2-P *	Socket for industrial Relay	•																				•				
S2-P0 *	Socket for industrial Relay	•																				•				
S3-B	Socket for industrial Relay		•											•	•				•	•			•			
S3-MP	Socket for industrial Relay		•											•	•				•	•			•			
S3-S	Socket for industrial Relay		•											•	•				•	•			•			
S3-P *	Socket for industrial Relay																		•	•			•			
S3-P0 *	Socket for industrial Relay																		•	•			•			
S3-M0	Socket for industrial Relay		•											•	•		•						•	•		
S3-M1	Socket for industrial Relay		•											•	•				•	•			•			
S3-M	Socket for industrial Relay		•											•	•				•	•			•			
S4-J	Socket for industrial Relay			•																						
S4-L	Socket for industrial Relay			•																						
S4-P	Socket for industrial Relay			•																						
S5-M	Socket for industrial Relay				•												•						•	•		
S5-L	Socket for industrial Relay				•																					
S5-P	Socket for industrial Relay																									
S7-C	Socket for industrial Relay					•															•	•				•
S7-I0	Socket for industrial Relay					•																•	•			
S7-16	Socket for industrial Relay					•																•	•			
S7-P *	Socket for industrial Relay					•																•				
S7-L *	Socket for industrial Relay					•																•				
S9-M	Socket for industrial Relay						•																			
S9-P	Socket for industrial Relay						•																			
S9-L *	Socket for industrial Relay						•																			
S9-P0	Socket for industrial Relay																									
S10	Socket for industrial Relay							•																		
S10-P	Socket for industrial Relay							•																		
S12	Socket for industrial Relay								•																	
S12-P	Socket for industrial Relay								•																	
S16-M	Socket for industrial Relay									•												•				
S18-M	Socket for industrial Relay										•											•				

* Discontinued, limited units may be still available from stock.



Socket Accessoires																		
Type	Description	S3-M	S3-M0	S3-M1	S2-B	S3-B	S5-M	S7-C	S10	S7-I0	S12	S9-M	S4-J	S7-L	S7-P	S9-L	S9-P	
CA-11	Code Ring (BAG 5 PCS)					•												
C-A2	Neutral-Connector (BAG 5 PCS or 50 PCS)	•	•	•			•											
SC-3	A1-Connector (BAG 10 PCS)		•	•			•											
LH-1	Label carrier transparent (BAG 5 PCS)	•	•	•														
SL-36	Label holder transparent (BAG 5 PCS)				•	•												
SP-36	Labeling strips (BAG 5 PCS)				•	•												
L-16	Labeling strips (BAG 5 PCS)	•	•	•														
SD-1T	Lock lid transparent (BAG 5 PCS)	•	•	•			•											
SD-1W	Lock lid white (BAG 5 PCS)	•	•	•			•											
B20-G	Bridge Bar grey (BAG 5 PCS)											•						
B20-R	Bridge Bar red (BAG 5 PCS)											•						
B20-A	Bridge Bar blue (BAG 5 PCS)											•						
PS-W	Labeling strips							•										
S7-BB	Bridge bar (BAG 5 PCS (5 x 4))							•		•								
S9-CH	Labeling srib white (BAG 10 PCS)									•		•						
S10-BB	Bridge bar (BAG 20 PCS (5 x 4))								•									
S10-RH	Labeling srib white (BAG 10 PCS)								•		•							
S10-RT	Transparent Cover (BAG 20 PCS)								•									
SA-0	Wall Adapter							•	•		•							
SS-T	Transparent Cover							•										
SS-W	White Cover							•										
V10-G	Bridge Bar grey (BAG 5 PCS)											•						
V10-R	Bridge Bar red (BAG 5 PCS)											•						
V10-A	Bridge Bar blue (BAG 5 PCS)											•						
V40-G	Bridge Bar grey (BAG 5 PCS)											•						
V40-R	Bridge Bar red (BAG 5 PCS)											•						
V40-A	Bridge Bar blue (BAG 5 PCS)											•						

S2-B

Socket for 8-pin Relays and Time Cubes

Rated Load	10 A / 300 V
-------------------	---------------------

Specifications

Rated impulse withstand voltage	2.5 kV rms / 1 min
- All terminals / DIN rail	2.5 kV rms / 1 min
- Terminal / Terminal	2.5 kV rms / 1 min
Cross-section of connecting wire	
- Single-wire	4 mm ² / AWG 12 or 2 x 2.5 mm ² / AWG 14
- Multi-wire	0.34 mm ² / AWG 22 - 2.5 mm ² / AWG 14
Nominal screw torque	0.7 Nm
Screw Dimensions (mm)	M3 Pozi slot
Mounting	TS-35 or Back Panel Mounting
Ambient temperature operation / storage	-40...60 °C / -40 ... 80 °C (no ice)
Weight	48g

Included Accessories

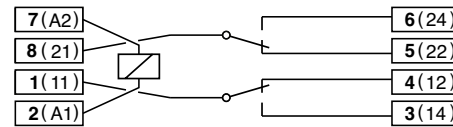
Retaining Clip, plastic	S30-CM for C2 / C2x Relays
-------------------------	----------------------------

Optional Accessories

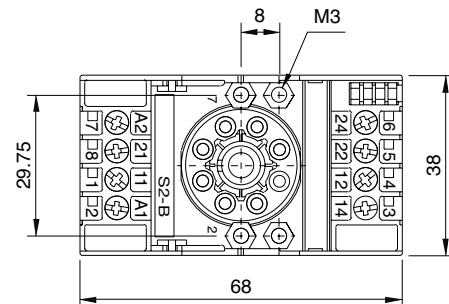
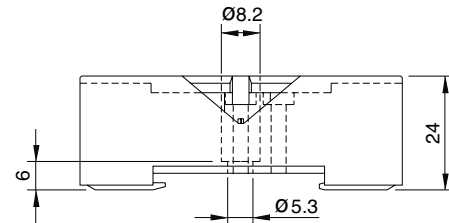
Retaining clip, steel	HF-32 (BAG 10 PCS) for C2 / C2x Relays HF-33 (BAG 10 PCS) for Time Cube CTx
-----------------------	--



Connection diagram



Dimensions (mm)



Technical approvals, conformities



S2-PO

Socket for 8-pin Relays and Time Cubes

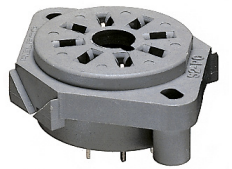
Rated Load	10 A / 300 V
-------------------	---------------------

Specifications

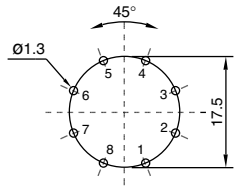
Rated impulse withstand voltage	2.5 kV rms / 1 min
- Pin / Pin	2.5 kV rms / 1 min
Ambient temperature operation/storage	-40 ... 60 °C / -40 ... 80 °C (no ice)
Weight	17g

Optional Accessories

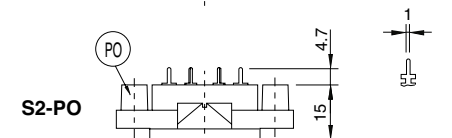
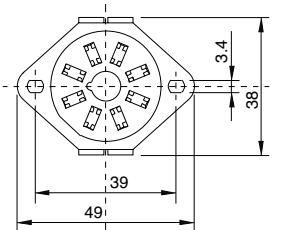
Retaining clip, steel	HF-32 (BAG 10 PCS) for C2 / C2x Relays HF-33 (BAG 10 PCS) for Time Cube CTx
-----------------------	--



Printed circuit lay-out (mm)



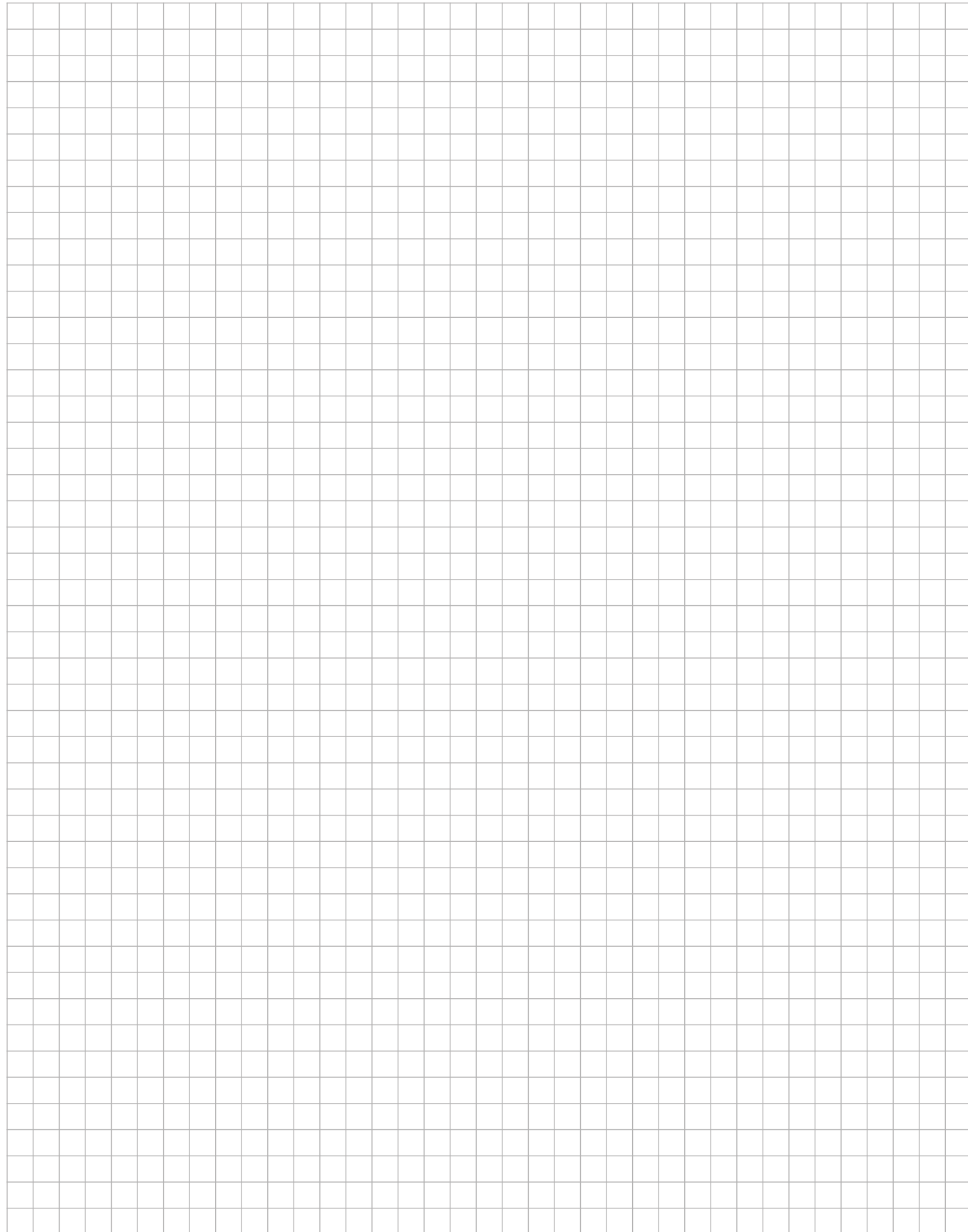
Dimensions (mm)











Technical approvals, conformities



Notes



4.2 11-Pin Sockets

Application	Type	Pins	Page
11-Pin Series			
Socket for 11-pin Relays and Time Cubes	S3-B		278
Socket for 11-pin standard Relays and Time Cubes	S3-S		279
Socket for 11-pin standard Relays	EC-11		280
Socket for 11-pin Relays and Time / Monitoring Module	S3-M		281
Socket for 11-pin Relays and Time / Monitoring Module	S3-M0 / S3-M1		282
Socket for 11-pin Relays	S5-M		283
PCB Socket for 11-pin Relays	S5-P		284
Socket for 11-pin Relays	S5-SSY		285

S3-B

Socket for 11-pin Relays and Time Cubes

Rated Load	10 A / 300 V
-------------------	---------------------

Specifications

Rated impulse withstand voltage	2.5 kV rms / 1 min
- All terminals / DIN rail	2.5 kV rms / 1 min
- Terminal / Terminal	2.5 kV rms / 1 min
Cross-section of connecting wire	
- Single-wire	4 mm ² / AWG 12 or 2 x 2.5 mm ² / AWG 14
- Multi-wire	0.34 mm ² / AWG 22 - 2.5 mm ² / AWG 14
Nominal screw torque	0.7 Nm
Screw Dimensions (mm)	M3 Pozi slot
Mounting	TS-35 or Back Panel Mounting
Ambient temperature	-40 ... 60 °C / -40 ... 80 °C (no ice)
Weight	55g

Included Accessories

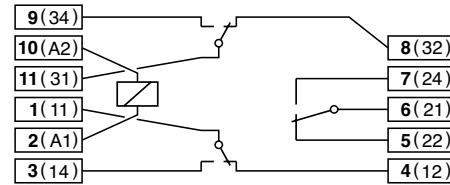
Retaining Clip, plastic	S30-CM for C3 / C3x Relays
-------------------------	----------------------------

Optional Accessories

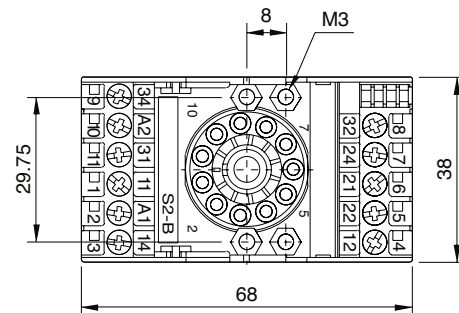
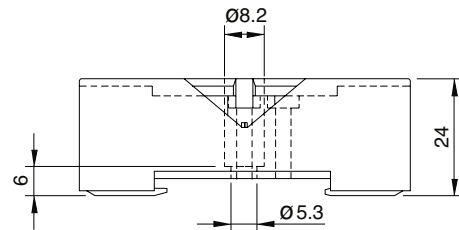
Retaining clip, steel	HF-32 (BAG 10 PCS) for C3 / C3x Relays HF-33 (BAG 10 PCS) for Time Cube CTx
Coding Ring	S3-BC (BAG 5 PCS) for C3 / C3x Relays



Connection diagram



Dimensions (mm)



Technical approvals, conformities



S3-S

Socket for 11-pin standard Relays and Time Cubes

Rated Load	10 A / 250 V
-------------------	---------------------

Specifications

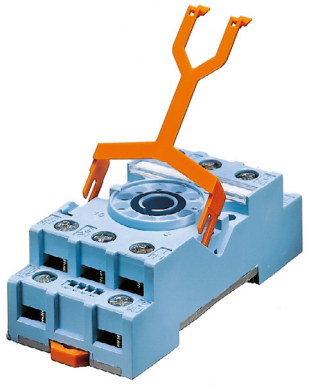
Rated impulse withstand voltage	2.5 kV rms / 1 min
- All terminals / DIN rail	2.5 kV rms / 1 min
- Terminal / Terminal	2.5 kV rms / 1 min
Cross-section of connecting wire	
- Single-wire	4 mm ² / AWG 12 or 2 x 2.5 mm ² / AWG 14
- Multi-wire	0.34 mm ² / AWG 22 - 2.5 mm ² / AWG 14
Nominal screw torque	1.2 Nm
Screw Dimensions (mm)	M3.5 Pozi slot
Mounting	TS-35 or Back Panel Mounting
Ambient temperature operation/storage	-40...60 °C / -40 ... 80 °C (no ice)
Weight	69g

Included Accessories

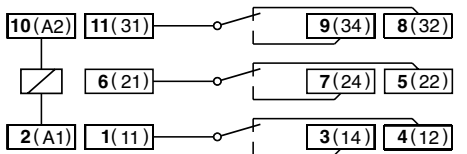
Retaining Clip, plastic	S30-CM for C3 / C3x Relays
-------------------------	----------------------------

Optional Accessories

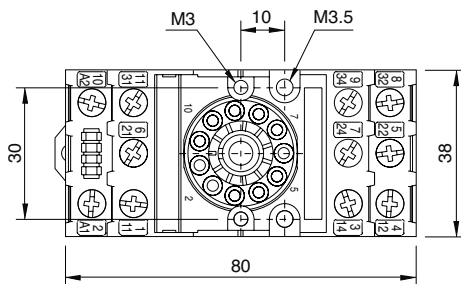
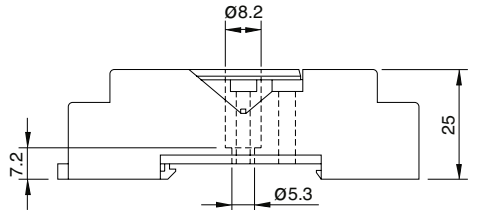
Retaining clip, steel	HF-32 (BAG 10 PCS) for C3 / C3x Relays HF-33 (BAG 10 PCS) for Time Cube CTx
Coding Ring	S3-BC (BAG 5 PCS) for C3 / C3x Relays



Connection diagram



Dimensions (mm)



Technical approvals, conformities



EC-11

Socket for 11-pin standard Relays

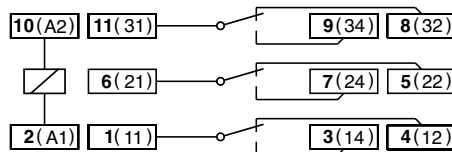
Rated Load 10 A / 400 V

Specifications

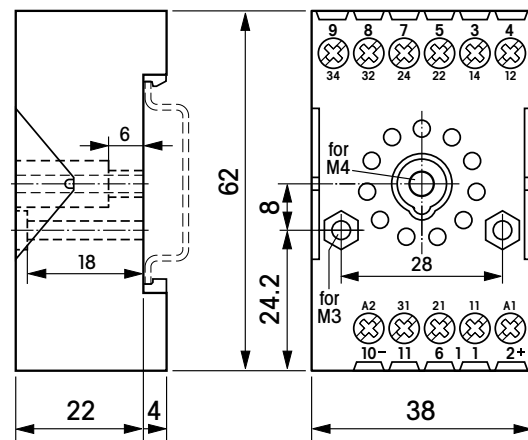
Rated impulse withstand voltage	2.5 kV rms / 1 min
- All terminals / DIN rail	2.5 kV rms / 1 min
- Terminal / Terminal	2.5 kV rms / 1 min
Cross-section of connecting wire	
- Single-wire	4 mm ² / AWG 12 or 2 x 2.5 mm ² / AWG 14
- Multi-wire	0.34 mm ² / AWG 22 - 2.5 mm ² / AWG 14
Nominal screw torque	0.7 Nm
Screw Dimensions (mm)	M3.5 Pozi slot
Mounting	TS-35 or Back Panel Mounting
Ambient temperature operation/storage	-25...60 °C / -40 ... 80 °C (no ice)
Weight	56 g



Connection diagram



Dimensions (mm)



Technical approvals, conformities



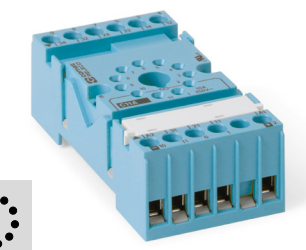
S3-M

Socket for 11-pin Relays and Time / Monitoring Module

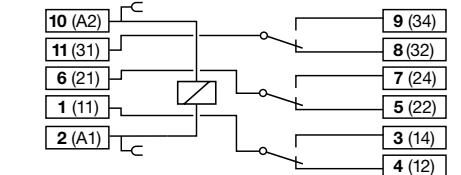
Rated Load 10 A / 250 V

Specifications

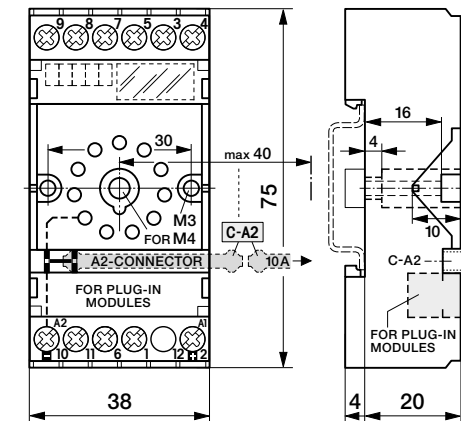
Rated impulse withstand voltage	2.5 kV rms / 1 min
- All terminals / DIN rail	2.5 kV rms / 1 min
- Terminal / Terminal	2.5 kV rms / 1 min
Cross-section of connecting wire	
- Single-wire	1 x 6 mm ² / AWG 10, 2 x 1.5 mm ² / AWG 16
- Multi-wire	1 x 4 mm ² / AWG 12, 2 x 1.5 mm ² / AWG 16
Nominal screw torque	0.7 Nm
Screw Dimensions (mm)	M3 Pozi slot
Mounting	TS-35 or Back Panel Mounting
Ambient temperature operation/storage	-25 ... 60 °C / -40 ... 80 °C (no ice)
Weight	61g



Connection diagram



Dimensions (mm)



Included Accessories

A2-Connector C-A2

Optional Accessories

Retaining clip, steel HF-32 (BAG 10 PCS) for C3 / C3x Relays
 HF-33 (BAG 10 PCS) for Time Cube CTx
 S3-BC (BAG 5 PCS) for C3 / C3x Relays
 C-A2 (BAG 5 PCS), C-A2 (BAG 50 PCS)
 RD1/DC12-220V
 RC1/UC110-240V

Technical approvals, conformities



IEC/EN 50155

S3-M0 / S3-M1

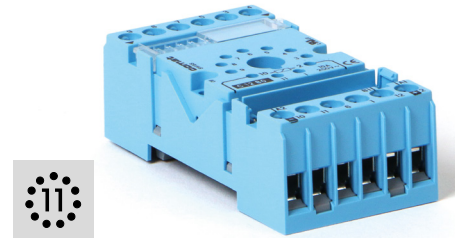
Socket for 11-pin Relays and Time / Monitoring Module

Rated Load	10 A / 250 V
-------------------	---------------------

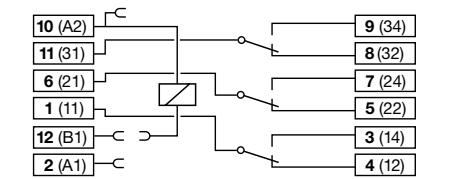
Specifications	
Rated impulse withstand voltage	2.5 kV rms / 1 min
- All terminals / DIN rail	2.5 kV rms / 1 min
- Terminal / Terminal	2.5 kV rms / 1 min
Cross-section of connecting wire	
- Single-wire	1 x 6 mm ² / AWG 10, 2 x 1.5 mm ² / AWG 16
- Multi-wire	1 x 4 mm ² / AWG 12, 2 x 1.5 mm ² / AWG 16
Nominal screw torque	0.7 Nm
Screw Dimensions (mm)	M3 Pozi slot
Mounting	TS-35 or Back Panel Mounting
Ambient temperature operation/storage	-25 ... 60 °C / -40 ... 80 °C (no ice)
Weight	61g

Included Accessories	
A2-Connector	C-A2

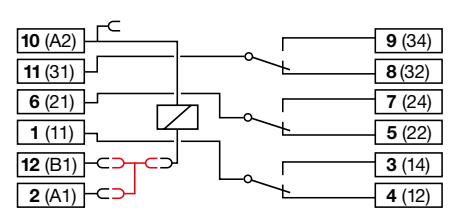
Optional Accessories	
Retaining clip, steel	HF-32 (BAG 10 PCS) for C3 / C3x Relays HF-33 (BAG 10 PCS) for Time Cube CTx S3-BC (BAG 5 PCS) for C3 / C3x Relays C-A2 (BAG 5 PCS), C-A2 (BAG 50 PCS) RD1/DC12-220V RC1/UC110-240V
Coding Ring	
A2-Connector	
Free-wheeling Diode Module	
RC-Suppressor Module	



Connection diagram S3-M0

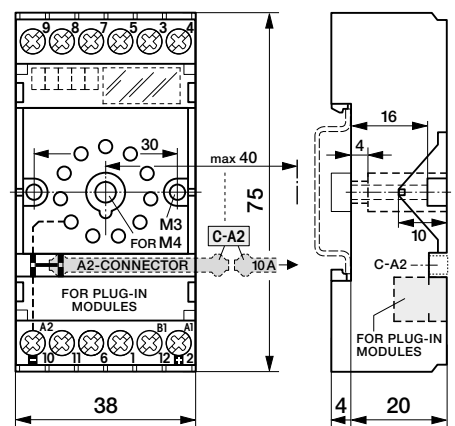


Connection diagram S3-M1



With Bridge Connector SC-3

Dimensions (mm)



Technical approvals, conformities



S5-M

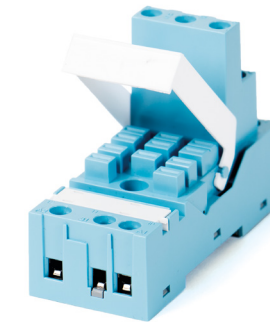
Socket for 11-pin Relays

Rated Load	16 A / 400 V
-------------------	---------------------

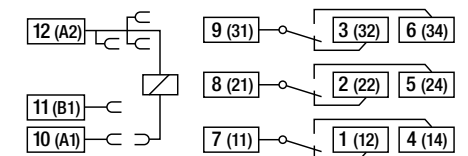
Specifications	
Rated impulse withstand voltage	4 kV rms / 1 min
- All terminals / DIN rail	4 kV rms / 1 min
- Terminal / Terminal	4 kV rms / 1 min
Cross-section of connecting wire	
- Single-wire	1 x 6 mm ² / AWG 10, 2 x 2.5 mm ² / AWG 14
- Multi-wire	1 x 6 mm ² / AWG 10, 2 x 1.5 mm ² / AWG 16
Nominal screw torque	1 Nm
Screw Dimensions (mm)	M3.5 Pozi slot
Mounting	TS-35 or Back Panel Mounting
Ambient temperature operation / storage	-40 ... 60° C / -40 ... 80° C (no ice)
Weight	92g

Integrated Accessories	
A2-Connector	C-A2
Retaining clip, plastic	S5M-CP for C5 / C5x Relays
A1-, B1-Connector	SC-3

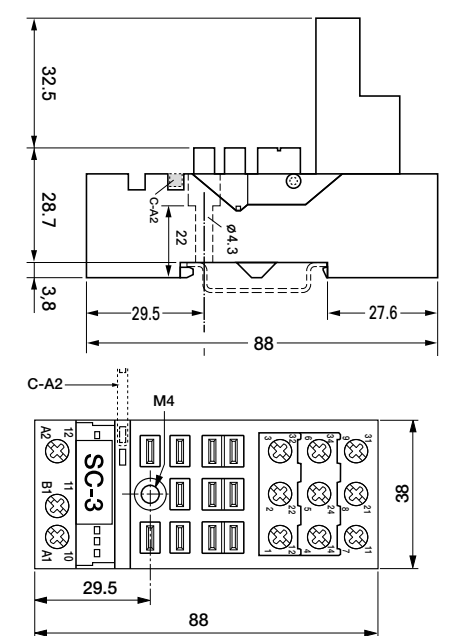
Optional Accessories	
Retaining Clip, steel	HF-32 (BAG 10 PCS) for C5 / C5x Relays
A2-Connector	C-A2 (BAG 5 PCS), C-A2 (BAG 50 PCS)
A1-, B1-Connector	SC-3 (BAG 10 PCS)



Connection diagram



Dimensions (mm)



Technical approvals, conformities



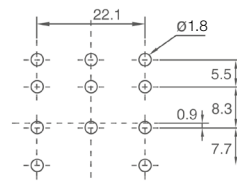
S5-P

PCB Socket for 11-pin Relays

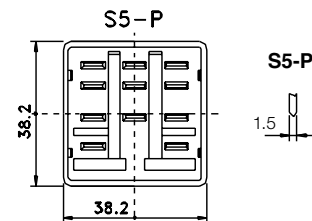
Rated Load	16 A / 400 V
Specifications	
Rated impulse withstand voltage	2.5 kV rms / 1 min
- Pin / Pin	-40 ... 60 °C / -40 ... 80 °C (no ice)
Ambient temperature operation/storage	-40 ... 60 °C / -40 ... 80 °C (no ice)
Weight	20g
Optional Accessories	
Retaining spring, steel	S5-CL (BAG 10 PCS) for C5 / C5x Relays



Printed circuit lay-out (mm)



Dimensions (mm)



S5-SSY

Socket for 11-pin Relays

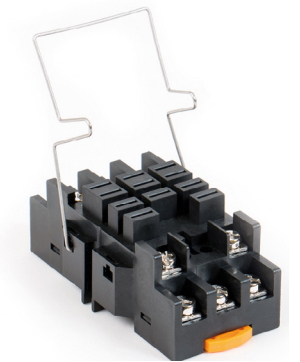
Rated Load	16 A / 400 V
Specifications	
Rated impulse withstand voltage	4 kV rms / 1 min
- All terminals / DIN rail	4 kV rms / 1 min
- Terminal / Terminal	4 kV rms / 1 min
Cross-section of connecting wire	1 x 6 mm ² / AWG 10, 2 x 2.5 mm ² / AWG 14
- Single-wire	1 x 6 mm ² / AWG 10, 2 x 1.5 mm ² / AWG 16
- Multi wire	1 Nm
Nominal screw torque	M3.5 Pozi slot
Screw Dimensions (mm)	TS-35 or Back Panel Mounting
Mounting	-40 ... 60° C / -40 ... 80° C (no ice)
Ambient temperature operation / storage	92g
Weight	

Integrated Accessories

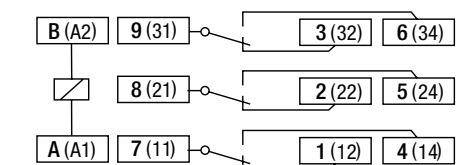
A2-Connector	C-A2
Retaining clip, plastic	S5M-CP for C5 / C5x Relays
A1-, B1-Connector	SC-3

Optional Accessories

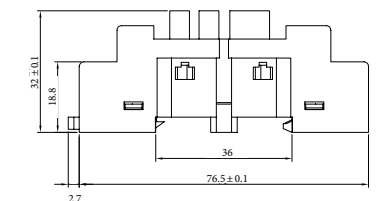
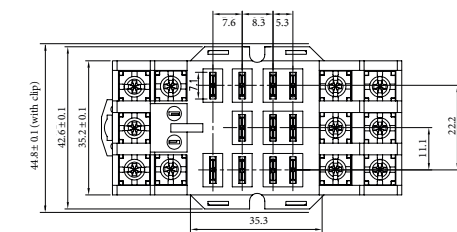
Retaining Clip, steel	HF-32 (BAG 10 PCS) for C5 / C5x Relays
A2-Connector	C-A2 (BAG 5 PCS), C-A2 (BAG 50 PCS)
A1-, B1-Connector	SC-3 (BAG 10 PCS)



Connection diagram



Dimensions (mm)



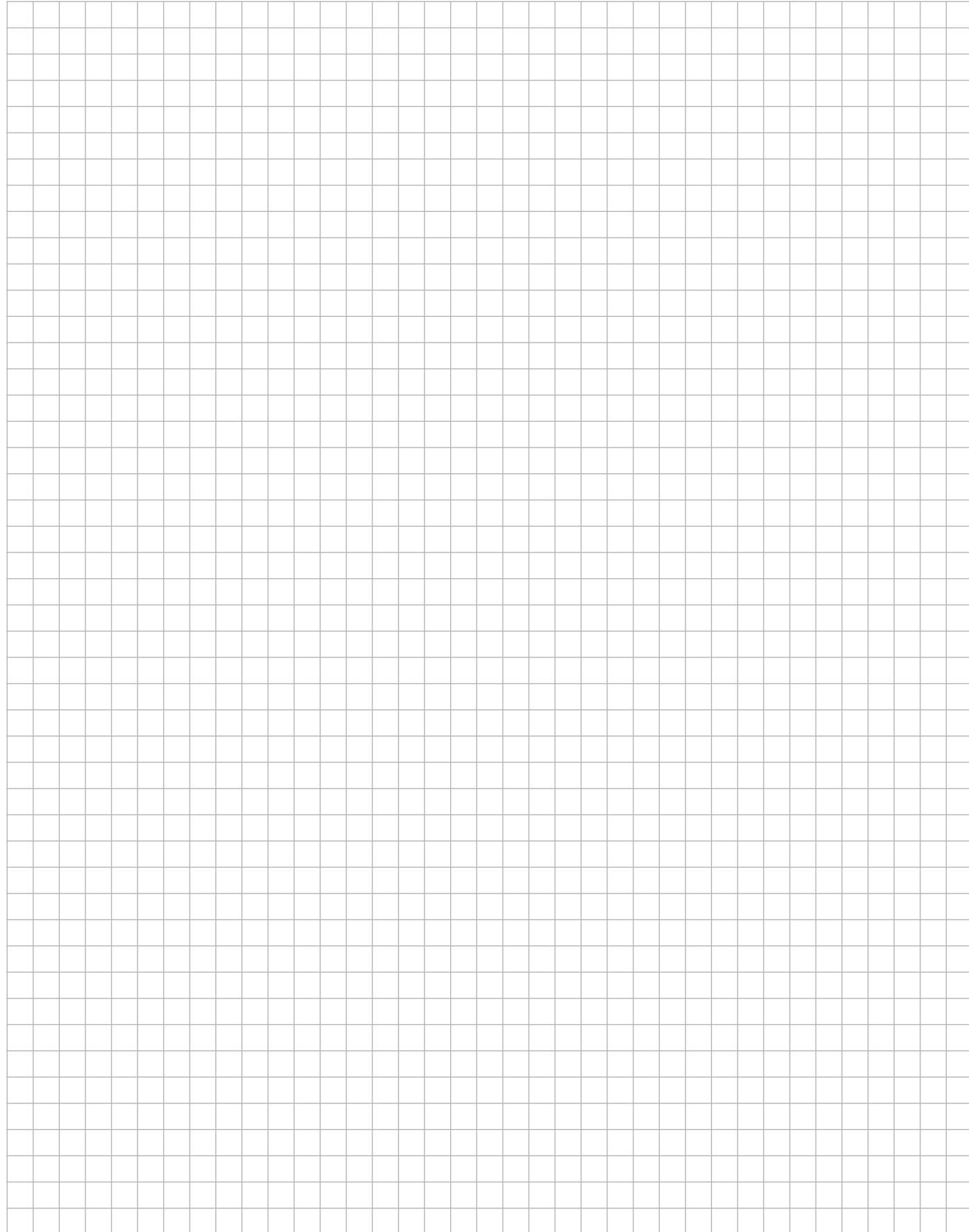
Technical approvals, conformities



Technical approvals, conformities



Notes



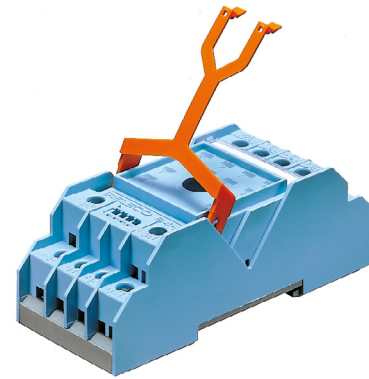
4.3 14-Pin Sockets

Application	Type	Pins	Page
14-Pin Series			
Socket for 14-pin C4 Relays	S4-J		288
PCB Socket for 14-pin C4 Relays	S4-P		289

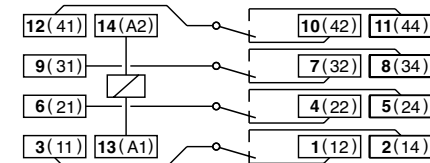
S4-J

Socket for 14-pin C4 Relays

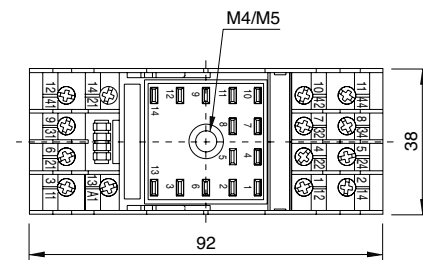
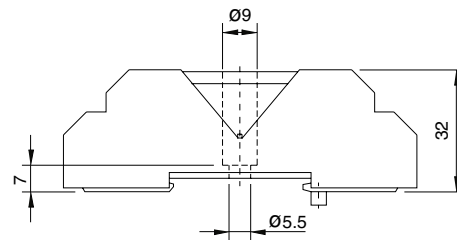
Rated Load	10 A / 250 V
Specifications	
Rated impulse withstand voltage	2.5 kV rms / 1 min
- All terminals / DIN rail	2.5 kV rms / 1 min
- Terminal / Terminal	2.5 kV rms / 1 min
Cross-section of connecting wire	
- Single-wire	1.5 mm ² / AWG 15 or 2 x 1.5 mm ² / AWG 15
- Multi-wire	0,34 mm ² / AWG 22 - 1 mm ² / AWG 17
Nominal screw torque	1 Nm
Screw Dimensions (mm)	M3.5 Phillips-slot (combo)
Mounting	TS-35 or Back Panel Mounting
Ambient temperature	-40 ... 60 °C / -40 ... 80 °C (no ice)
Weight	80g
Included Accessories	
Retaining Clip, plastic	S3-C for C4 / C4x Relays
Optional Accessories	
Retaining Clip, plastic	S3-C (BAG 10 PCS) for C4 Relays



Connection diagram



Dimensions (mm)



Technical approvals, conformities



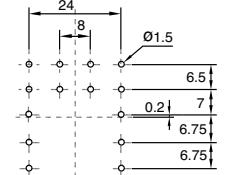
S4-P

PCB Socket for 14-pin C4 Relays

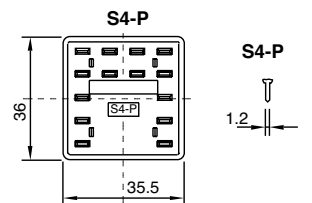
Rated Load	10 A / 250 V
Specifications	
Rated impulse withstand voltage	2.5 kV rms / 1 min
- Pin / Pin	2.5 kV rms / 1 min
Ambient temperature	-30 °C ... +60 °C (no ice)
Weight	21g
Optional Accessories	
Retaining spring, steel	S4-CL (BAG 10 PCS) for C4 / C4x Relays



Printed circuit lay-out (mm)



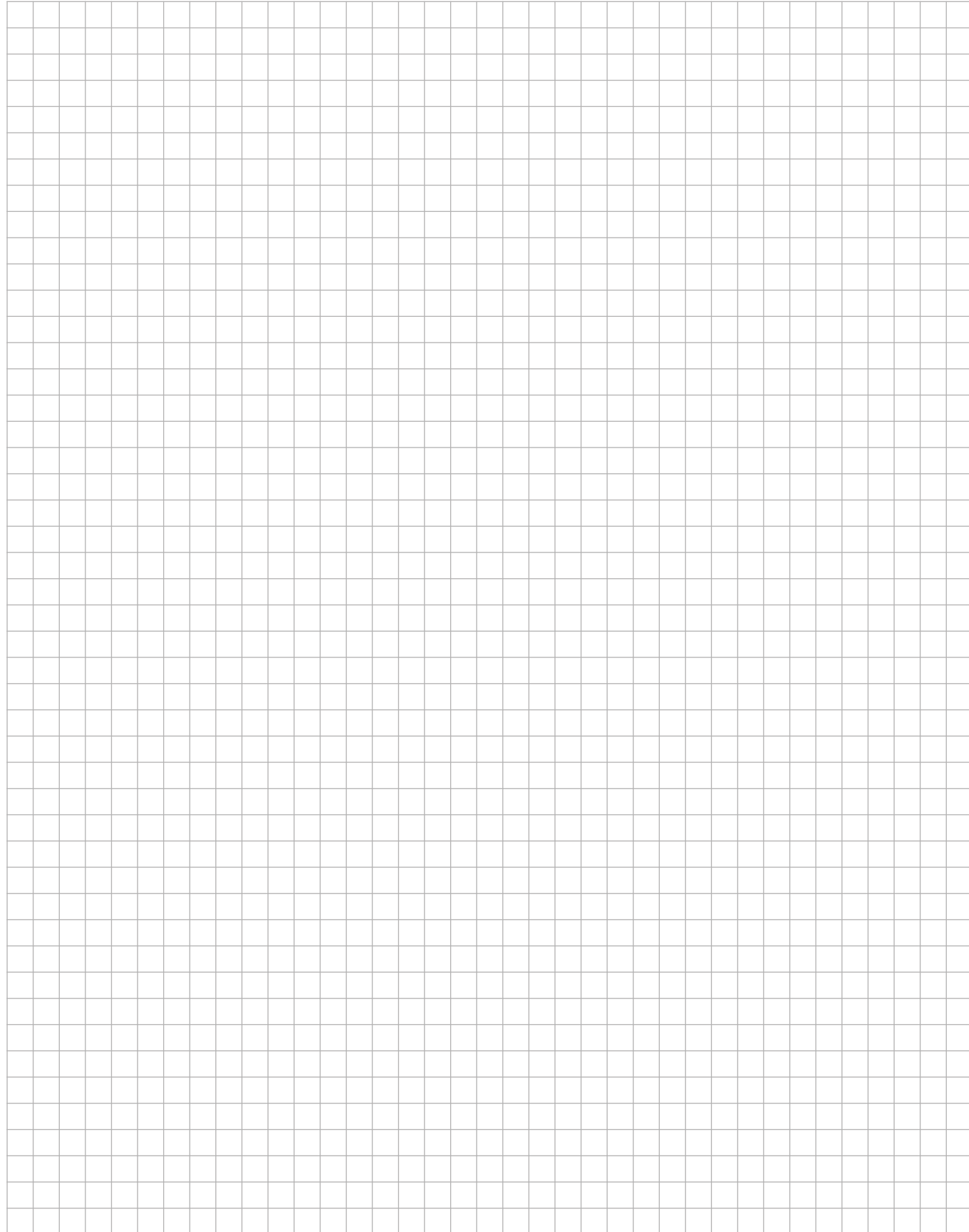
Dimensions (mm)








Technical approvals, conformities



Notes



4.4 8/14-Pin Sockets

Application	Type	Pins	Page
8/14-Pin Series			
Socket for 8-pin Relays	S7-C		292
Socket for 8-pin Relays	S7-IO		293
PCB Socket for 8-pin Relays	S7-P		294
Socket for 14-pin Relays	S9-M		295
PCB Socket for 14-pin Relays	S9-P		296

S7-C

Socket for 8-pin Relays

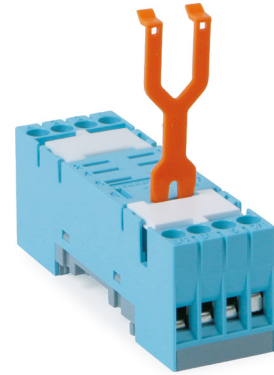
Rated Load	10A, 16A for 1 pole / 250 V
-------------------	------------------------------------

Specifications	
Rated impulse withstand voltage	2.5 kV rms / 1 min
- All terminals / DIN rail	2.5 kV rms / 1 min
- Terminal / Terminal	2.5 kV rms / 1 min
Cross-section of connecting wire	
- Single-wire	4 mm ² / AWG 12, 2 x 1.5 mm ² / AWG 16
- Multi wire	2.5 mm ² / AWG 14, 2 x 1 mm ² / AWG 18
Nominal screw torque	0.7 Nm
Screw Dimensions (mm)	M3 Pozi slot
Mounting	TS-35 or Back Panel Mounting
Ambient temperature operation/storage	-40...60°C (50°C for 16A) / -40...80°C (no ice)
Weight	37g

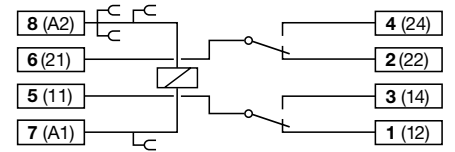
Included Accessories	
Retaining clip, plastic	CP-07B for C7 / C7x Relays

Optional Accessories	
Retaining clip, plastic	CP-07B (BAG 50 PCS) for C7 / C7x Relays
A2-Connector	S7-BB (BAG 20 PCS)
Panel Adapter	S9-G (BAG 10 PCS)

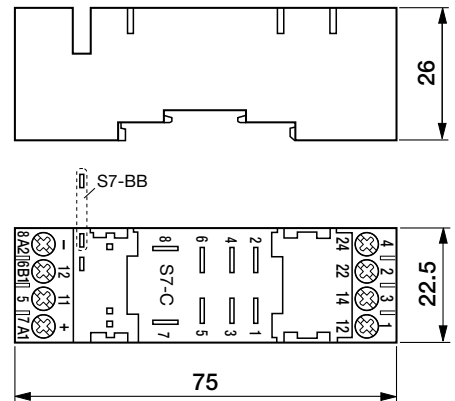
Please Note:
This socket replaces former socket S7-M and S7-16



Connection diagram



Dimensions (mm)



Technical approvals, conformities



S7-IO

Socket for 8-pin Relays

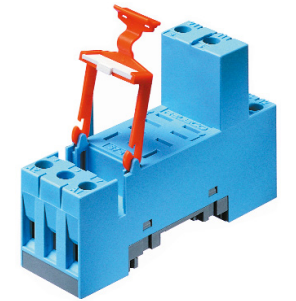
Rated Load	10 A / 250 V
-------------------	---------------------

Specifications	
Rated impulse withstand voltage	2.5 kV rms / 1 min
- All terminals / DIN rail	2.5 kV rms / 1 min
- Terminal / Terminal	2.5 kV rms / 1 min
Cross-section of connecting wire	
- Single-wire	4 mm ² / AWG 12, 2 x 2.5 mm ² / AWG 14
- Multi wire	0.34 mm ² / AWG 22 - 2.5 mm ² / AWG 14
Nominal screw torque	0.7 Nm
Screw Dimensions (mm)	M3 Pozi slot
Mounting	TS-35 or Back Panel Mounting
Ambient temperature operation/storage	-40...60 °C / -40 ... 80 °C (no ice)
Weight	38g

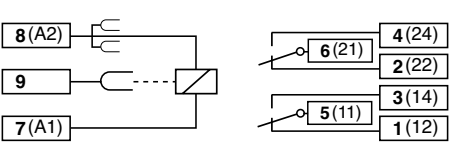
Included Accessories	
Retaining clip, plastic	S9-C for C7 / C7x Relays

Optional Accessories	
Retaining clip, plastic	S9-C (BAG 10 PCS) for C7 / C7x Relays
A2-Connector	S7-BB (BAG 20 PCS)
Panel Adapter	S9-G (BAG 10 PCS)

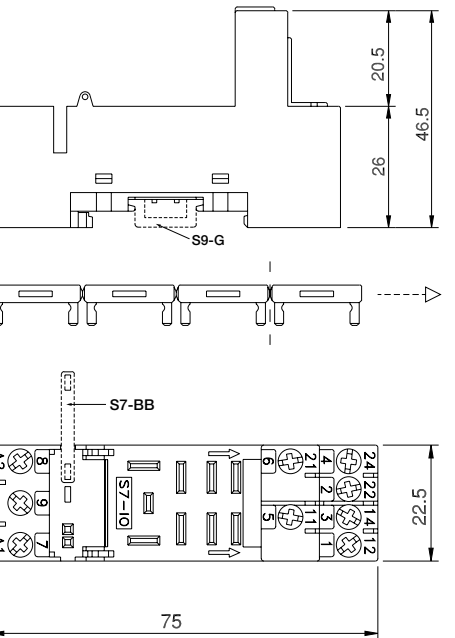
Please Note:
This socket replaces former socket S7-M and S7-16



Connection diagram



Dimensions (mm)



Technical approvals, conformities



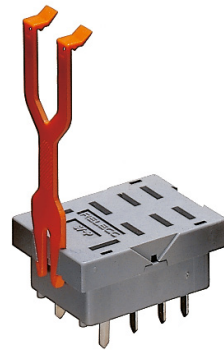
S7-P

PCB Socket for 8-pin Relays

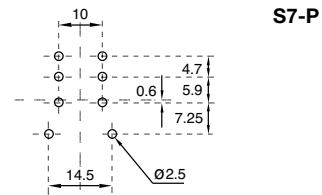
Rated Load	10 A / 250 V
Specifications	
Rated impulse withstand voltage	2.5 kV rms / 1 min
- Pin / Pin	-40 ... 60 °C / -40 ... 80 °C (no ice)
Ambient temperature operation/storage	-40 ... 60 °C / -40 ... 80 °C (no ice)
Weight	10g

Included Accessories	CP-07B for C7 / C7x Relays
Retaining clip, plastic	

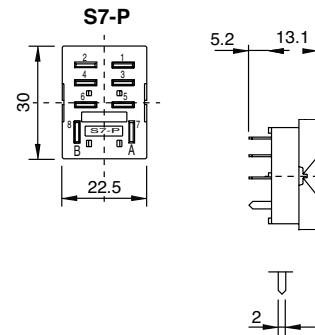
Optional Accessories	CP-07B (BAG 50 PCS) for C7 / C7x Relays
Retaining clip, plastic	



Printed circuit lay-out (mm)



Dimensions (mm)



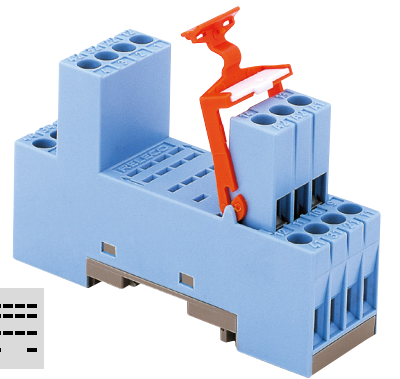
S9-M

Socket for 14-pin Relays

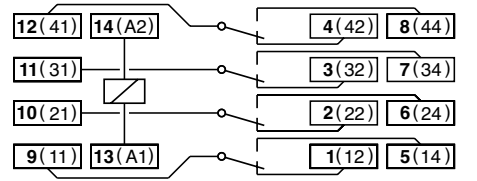
Rated Load	6 A / 250 V
Specifications	
Rated impulse withstand voltage	2.5 kV rms / 1 min
- All terminals / DIN rail	2.5 kV rms / 1 min
- Terminal / Terminal	2.5 kV rms / 1 min
Cross-section of connecting wire	4 mm ² / AWG 12 or 2 x 2.5 mm ² / AWG 14
- Single-wire	0.34mm ² / 22 - 2.5 mm ² / AWG 14
- Multi-wire	0.7 Nm
Nominal screw torque	M3 Pozi slot
Screw Dimensions (mm)	TS-35 or Back Panel Mounting
Mounting	-40 ... 60 °C / -40 ... 80 °C (no ice)
Ambient temperature operation/storage	-40 ... 60 °C / -40 ... 80 °C (no ice)
Weight	54g

Included Accessories	S9-C for C9 / C9x Relays
Retaining clip, plastic	

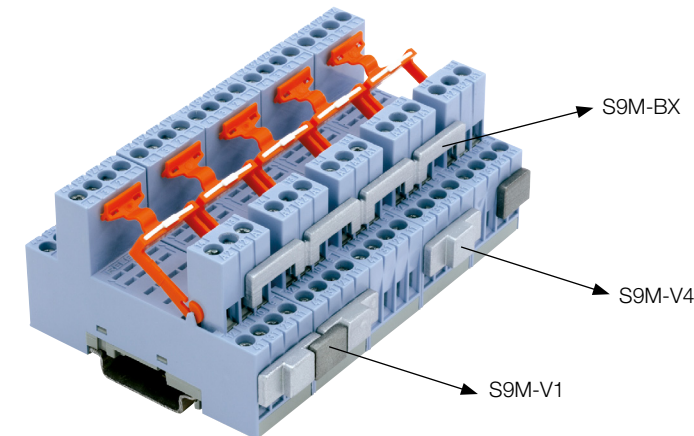
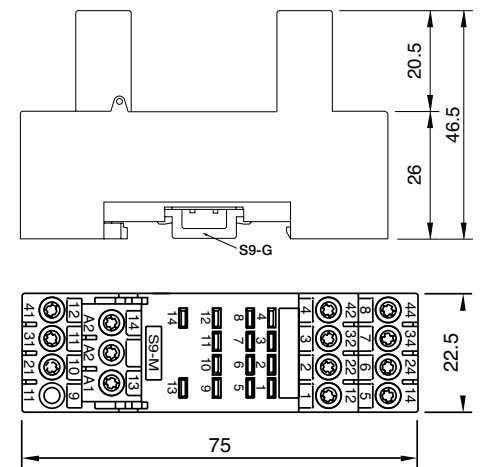
Optional Accessories	S9-C (BAG 10 PCS) for C9 / C9x Relays
Retaining clip, plastic	S9-G (BAG 10 PCS)
Panel Adapter	S9M-V1 (BAG 5 PCS)
Bridge Bar	S9M-V4 (BAG 5 PCS)
Bridge Bar	S9M-BX (BAG 5 PCS)



Connection diagram



Dimensions (mm)



Technical approvals, conformities



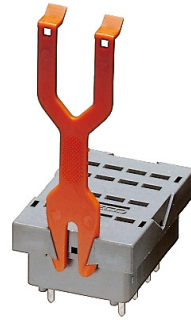
Technical approvals, conformities



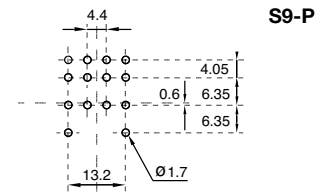
S9-P

PCB Socket for 14-pin Relays

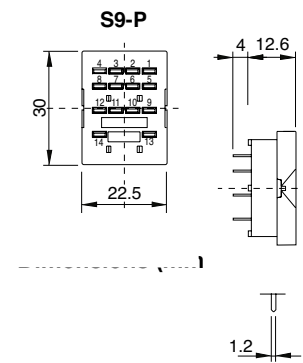
Rated Load	6 A / 150 V
Specifications	
Rated impulse withstand voltage – Pin / Pin	1.5 kV rms / 1 min
Ambient temperature operation/storage	-40 ... 60 °C / -40 ... 80 °C (no ice)
Weight	12g
Included Accessories	
Retaining clip, plastic	CP-07B for C9 / C9x Relays
Optional Accessories	
Retaining clip, plastic	CP-07B (BAG 50 PCS) for C9 / C9x Relays



Printed circuit lay-out (mm)



Dimensions (mm)



4.5 **5/8-Pin Sockets**

Application	Type	Pins	Page
5/8-Pin Series			
Socket for 5-pin Relays	S10		298
PCB Socket for 5-pin Relays	S10-P		299
Socket for 8-pin Relays	S12		300
PCB Socket for 8-pin Relays	S12-P		301
Socket for 8-pin Relays	S16-M		302
Socket for 8-pin Relays	S18-M		303

This print socket must be used in pollution degree 2 environment only, hence office, laboratory, household or similar. It is not suitable for industry environment (pollution degree 3).

Maximum voltage between two separate circuits on neighbouring contacts: 150 V
Not permitted: 24 V DC next to 230 V AC, 230 V AC next to neutral, 230 V AC next to 230 V AC of different phases
Permitted: 230 V AC next to 230 V AC same phase

Technical approvals, conformities



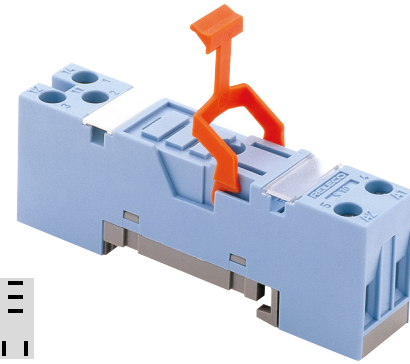
S10

Socket for 5-pin Relays

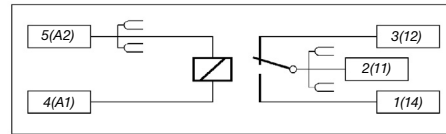
Rated Load	10 A / 250 V
Specifications	
Rated impulse withstand voltage	5 kV rms / 1 min
- All terminals / DIN rail	5 kV rms / 1 min
- Contact / Terminals	2.5 kV rms / 1 min
- Contact / Coil terminals	5 kV rms / 1 min
Cross-section of connecting wire	
- Single-wire	4 mm ² / AWG 12 or 2 x 2.5 mm ² / AWG 14
- Multi-wire	0.34mm ² / 22 - 2.5 mm ² / AWG 14
Nominal screw torque	0.7 Nm
Screw Dimensions (mm)	M3 Pozi slot
Mounting	TS-35 or Back Panel Mounting
Ambient temperature operation/storage	-40...60 °C / -40 ... 80 °C (no ice)
Weight	23g

Included Accessories	S10-C for C10 / C10x Relays
Retaining Clip, plastic	

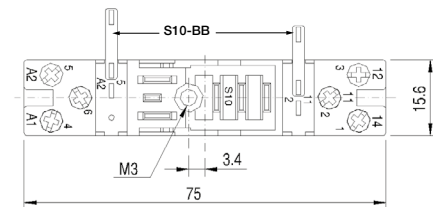
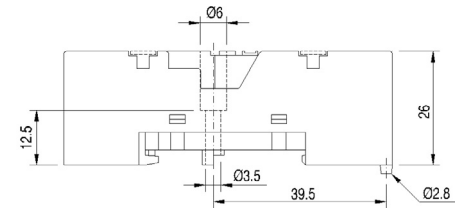
Optional Accessories	S10-C / CP-17B (BAG 10 PCS) for C10 / C10x
Retaining clip, plastic	
Bridge bar	S10-BB (BAG 20 PCS)



Connection diagram



Dimensions (mm)



Technical approvals, conformities



S10-P

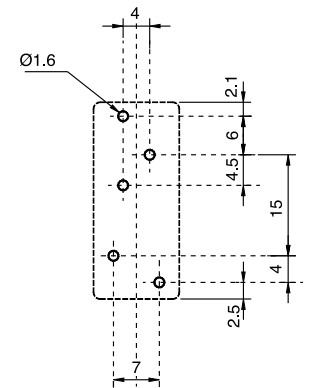
PCB Socket for 5-pin Relays

Rated Load	10 A / 250 V
Specifications	
Rated impulse withstand voltage	5 kV rms / 1 min
- Pin / Pin	5 kV rms / 1 min
Ambient temperature operation/storage	-40 ... 60 °C / -40 ... 80 °C (no ice)
Weight	7g

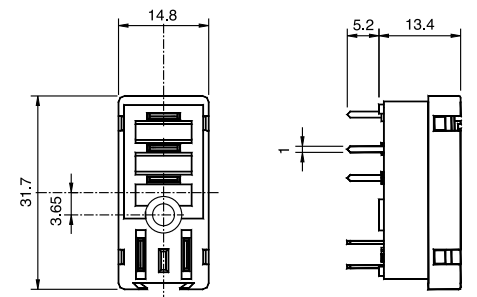
Included Accessories	Retaining clip, plastic
-----------------------------	-------------------------



Printed circuit lay-out (mm)



Dimensions (mm)



Technical approvals, conformities



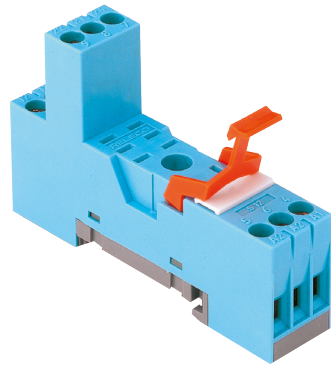
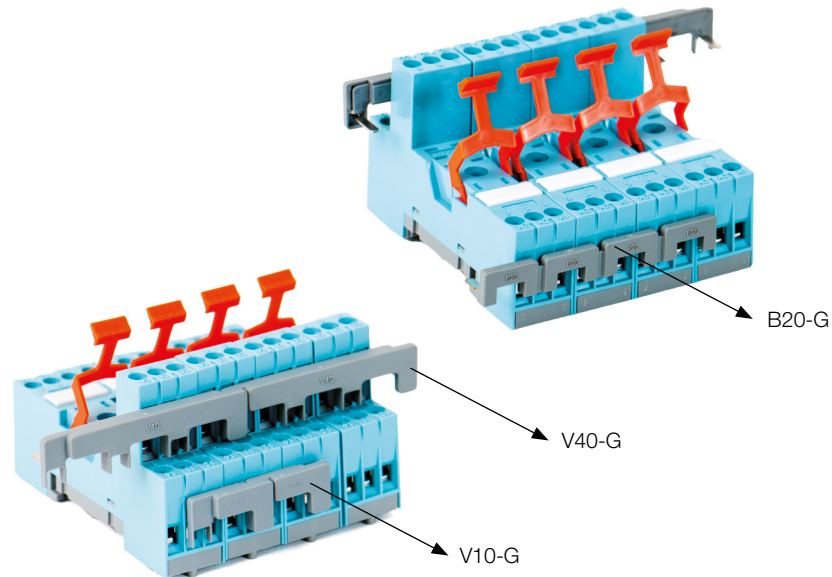
S12

Socket for 8-pin Relays

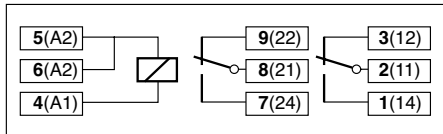
Rated Load	5 A / 250 V
Specifications	
Rated impulse withstand voltage	5 kV rms / 1 min
- All terminals / DIN rail	2.5 kV rms / 1 min
- Contact / Terminals	5 kV rms / 1 min
- Contacts / Coil terminals	
Cross-section of connecting wire	
- Single-wire	4 mm ² / AWG 12 or 2 x 2.5 mm ² / AWG 14
- Multi-wire	0.34mm ² / 22 - 2.5 mm ² / AWG 14
Nominal screw torque	0.7 Nm
Screw Dimensions (mm)	M3 Pozi slot
Mounting	TS-35 or Back Panel Mounting
Ambient temperature operation/storage	-40 ... 60 °C / -40 ... 80 °C (no ice)
Weight	31g

Included Accessories	
Retaining Clip, plastic	S10-C for C12 / C12x Relays

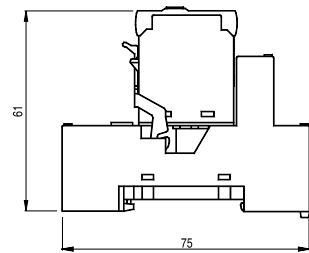
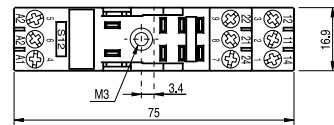
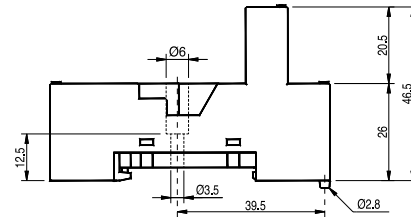
Optional Accessories	
Retaining Clip, plastic	S10-C / CP-17B (BAG 10 PCS) for C12 / C12x Relays
A2-Connector grey	B20-G (BAG 5 PCS)
A2-Connector red	B20-R (BAG 5 PCS)
A2-Connector blue	B20-A (BAG 5 PCS)
Bridge Bar twofold grey	V10-G (BAG 5 PCS)
Bridge Bar twofold red	V10-RC (BAG 5 PCS)
Bridge Bar twofold blue	V10-AC (BAG 5 PCS)
Bridge Bar fourfold grey	V40-G (BAG 5 PCS)
Bridge Bar fourfold red	V40-R (BAG 5 PCS)
Bridge Bar fourfold blue	V40-AC (BAG 5 PCS)



Connection diagram



Dimensions (mm)



Technical approvals, conformities

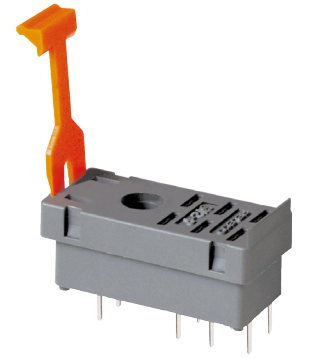


S12-P

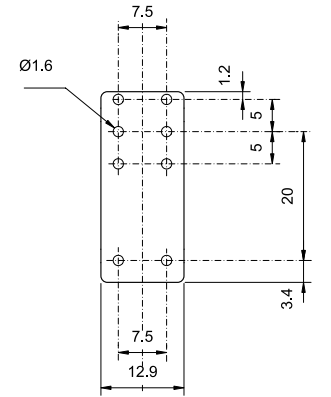
PCB Socket for 8-pin Relays

Rated Load	5 A / 250 V
Specifications	
Rated impulse withstand voltage	3 kV rms / 1 min
- Pin / Pole	5 kV rms / 1 min
- Coil / contact terminals	
Weight	7g

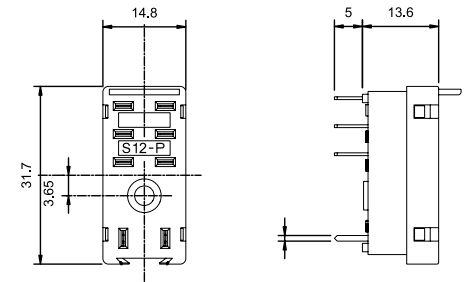
Included Accessories	
Retaining clip, plastic	CP-24B (BAG 10 PCS) for C12 / C12x Relays



Printed circuit lay-out (mm)



Dimensions (mm)



Technical approvals, conformities



S16-M

Socket for 8-pin Relays

Rated Load 10 A / 300 V

Specifications

Rated impulse withstand voltage	3 kV rms / 1 min
- All terminals / DIN rail	3 kV rms / 1 min
- Terminal / Terminal	3 kV rms / 1 min
- Terminal / Coil	3 kV rms / 1 min
Cross-section of connecting wire	
- Single-wire	1 × 0.5 mm ² / AWG 20
- Multi-wire	1 × 2.5 mm ² / AWG 14 or 2 × 1.0 mm ² / AWG 18
Nominal screw torque	0.7 Nm
Screw Dimensions (mm)	M3 Pozi 1 slot 2
Mounting	TS-35 or Back Panel Mounting
Ambient temperature	-40...60 °C / -40 ... 80 °C (no ice)
Weight	42 g

Included Accessories

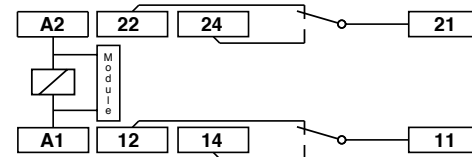
Retaining / Ejector clip, plastic CP-16

Optional Accessories (modules)

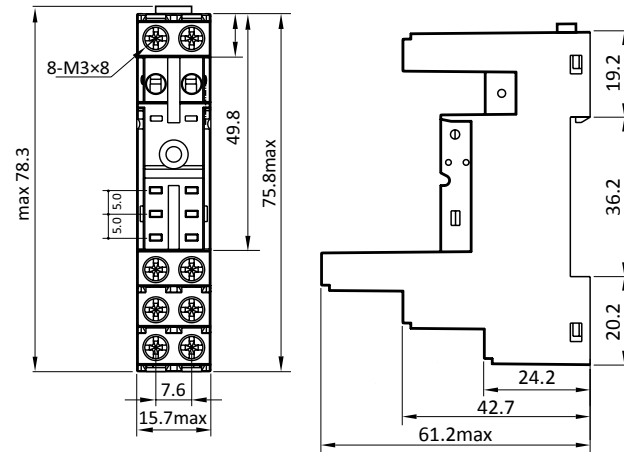
Free wheeling diode	RD16/DC12-240V
Green LED & free wheeling diode, 6-24V DC	RDL16/DC6-24V
Green LED & free wheeling diode, 24-60V DC	RDL16/DC24-60V
Green LED & free wheeling diode, 110-240V DC	RDL16/DC110-240V
Green LED, 6-24V AC/DC	RL16/UC6-24V
Green LED, 24-60V AC/DC	RL16/UC24-60V
Green LED, 110-240V AC/DC	RL16/UC110-240V
RC-Network 6-24V	RC16/UC6-24V
RC-Network 24-60V	RC16/UC24-60V
RC-Network 110-240V	RC16/UC110-240V



Connection diagram



Dimensions (mm)



Technical approvals, conformities



S18-M

Socket for 8-pin Relays

Rated Load 10 A / 300 V

Specifications

Rated impulse withstand voltage	3 kV rms / 1 min
- All terminals / DIN rail	3 kV rms / 1 min
- Terminal / Terminal	3 kV rms / 1 min
- Terminal / Coil	3 kV rms / 1 min
Cross-section of connecting wire	
- Single-wire	1 × 0.5 mm ² / AWG 20
- Multi-wire	1 × 2.5 mm ² / AWG 14 or 2 × 1.0 mm ² / AWG 18
Nominal screw torque	0.7 Nm
Screw Dimensions (mm)	M3 Pozi 1 slot 2
Mounting	TS-35 or Back Panel Mounting
Ambient temperature	-40 ... 60 °C / -40 ... 80 °C (no ice)
Weight	42 g

Included Accessories

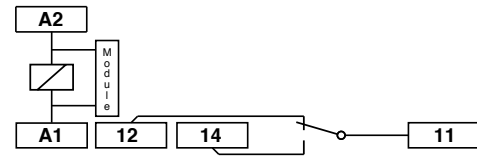
Retaining / Ejector clip, plastic CP-16

Optional Accessories (modules)

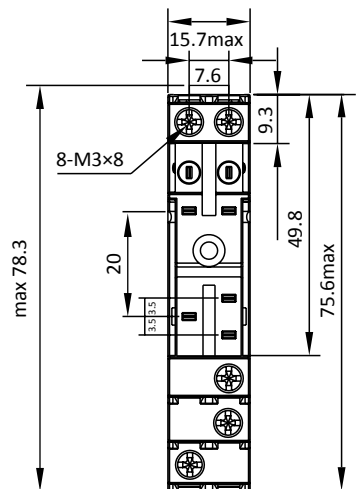
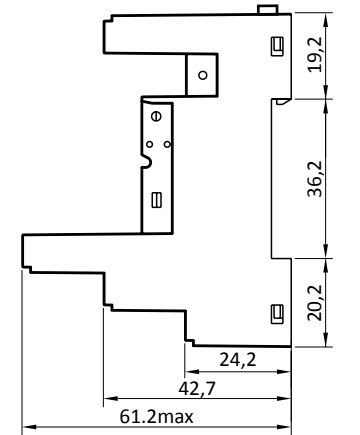
Free wheeling diode	RD16/DC12-240V
Green LED & free wheeling diode, 6-24V DC	RDL16/DC6-24V
Green LED & free wheeling diode, 24-60V DC	RDL16/DC24-60V
Green LED & free wheeling diode, 110-240V DC	RDL16/DC110-240V
Green LED, 6-24V AC/DC	RL16/UC6-24V
Green LED, 24-60V AC/DC	RL16/UC24-60V
Green LED, 110-240V AC/DC	RL16/UC110-240V
RC-Network 6-24V	RC16/UC6-24V
RC-Network 24-60V	RC16/UC24-60V
RC-Network 110-240V	RC16/UC110-240V



Connection diagram



Dimensions (mm)



Technical approvals, conformities



Notes

5.1 ComatReleco Messaging System (SMS Relay)

Application	Type	Page
CMS-Series		
6 digital inputs 4 relay outputs 12 ... 48 V DC 110 ... 240 V AC	CMS-10F	308
6 analogue / digital inputs 4 relay outputs 12 ... 48 V DC	CMS-10ADF	309
4 analogue / digital inputs 2 inputs 4 ... 20 mA 4 relay outputs 12 ... 48 V DC	CMS-10ACDF	310

CMS-10F**6 digital inputs | 4 relay outputs | 12 ... 48 V DC | 110 ... 240 V AC**

Power supply		
Nominal voltage	12 ... 48 V DC	110 ... 240 V AC
Operating voltage range	10 ... 60 V DC	85 ... 250 V AC
Power consumption AC/DC	8 VA / 4.2 W	
Rated frequency	45 ... 63 Hz	
Inputs		
Number of digital inputs	6	
Nominal voltage digital inputs	12 ... 48 V DC	110 ... 240 V AC
High level threshold digital Inputs	9.5 V DC	85 V AC
Outputs		
Number of relay outputs	4	
Contact Material	AgNi	
Rated voltage	250 V AC	
Rated current	10 A	
Minimum contact load relay outputs	10 mA, 12V	
Inrush current	15 A, 20 ms	
Rated load AC-1	2500 VA	
Mechanical endurance	3 x 10 ⁷	
Electrical endurance at rated load AC-1	150 000	
Communication		
Communication standards	GSM (2G), as of Q2 2019 UMTS (3G), LTE (4G)	
Frequencies	850 / 900 / 1800 / 1900 MHz	
Antenna connector	SMA female	
Insulation		
Rated test voltage control / main circuit	2.5 kV, 1 min	
Rated test voltage main / main circuit	2.5 kV, 1 min	
Pollution degree	3	
Overvoltage category	II	
General data		
Ambient temperature storage	-40 ... 85 °C	
Ambient temperature operation	-25 ... 55 °C	
Conductor cross section	2.5 mm ²	
Nominal screw torque	0.5 Nm	
Weight	120 g	
Protection degree	IP20	
Housing material	PC	

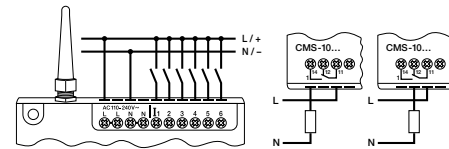
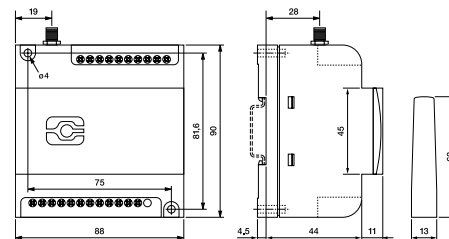
Product references

Types	Product reference	12-48	110-240
DC supply	CMS-10F/DC...V	✓	
DC supply, kit (*included accessories)	CMS-10FKIT/DC...V	✓	
AC supply	CMS-10F/AC...V		✓
AC supply, kit (*included accessories)	CMS-10FKIT/AC...V		✓

“...” list control circuit voltage to complete product references.

Accessories

Antennas	CMS-ANT-SPEZ/5M, CMS-ANT-MAG/2.5M*
Antenna cables	CMS-ANT-KAB/5M, CMS-ANT-KAB/10M, CMS-ANT-KAB/20M
Programming cable	CMS-RS232*
USB to serial converter	CMS-USB*
Power supply 15W, 24V	DR-15-24
Power supply 30W, 24V	DR-30-24
PT100 / PT1000 amplifier	MV-LKM-274
Indoor temperature sensor with display, 0 ... 50 °C	CRF01-U-D
Indoor temperature sensor, 0 ... 50 °C	CRF01-U
Exterior temperature sensor, -50 ... +50 °C	CWF50-EXT-U4
Thermostat, 5 ... 30 °C	CRTBSB-001-010
Temperature / humidity sensor	KS-110
Water level sensor	PS1

**fig. 1. Wiring diagram****fig. 2. Dimensions (mm)****Standards and approvals**

Standards IEC/EN 60947, IEC/EN60730

Approvals **CMS-10ADF****6 analogue / digital inputs | 4 relay outputs | 12 ... 48 V DC**

Power supply	
Nominal voltage	12 ... 48 V DC
Operating voltage range	10 ... 60 V DC
Power consumption AC/DC	4.2 W
Inputs	
Number of analogue / digital inputs	6
Nominal voltage digital inputs	12 ... 48 V DC
High level threshold digital Inputs	9.5 V DC
Nominal range analogue inputs	0 ... 10 V
Resolution of analogue inputs	10 Bit
Outputs	
Number of relay outputs	4
Contact Material	AgNi
Rated voltage	250 V AC
Rated current	10 A
Minimum contact load relay outputs	10 mA, 12V
Inrush current	15 A, 20 ms
Rated load AC-1	2500 VA
Mechanical endurance	3 x 10 ⁷
Electrical endurance at rated load AC-1	150 000
Communication	
Communication standards	GSM (2G), as of Q2 2019 UMTS (3G), LTE (4G)
Frequencies	850 / 900 / 1800 / 1900 MHz
Antenna connector	SMA female
Insulation	
Rated test voltage control / main circuit	2.5 kV, 1 min
Rated test voltage main / main circuit	2.5 kV, 1 min
Pollution degree	3
Overvoltage category	II
General data	
Ambient temperature storage	-40 ... 85 °C
Ambient temperature operation	-25 ... 55 °C
Conductor cross section	2.5 mm ²
Nominal screw torque	0.5 Nm
Weight	120 g
Protection degree	IP20
Housing material	PC

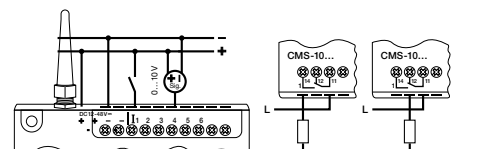
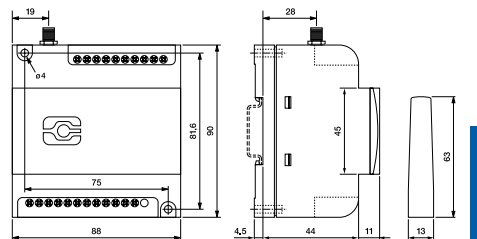
Product references

Types	Product reference	12-48
DC supply	CMS-10ADF/DC...V	✓
DC supply, kit (*included accessories)	CMS-10ADFKIT/DC...V	✓

“...” list control circuit voltage to complete product references.

Accessories

Antennas	CMS-ANT-SPEZ/5M, CMS-ANT-MAG/2.5M*
Antenna cables	CMS-ANT-KAB/5M, CMS-ANT-KAB/10M, CMS-ANT-KAB/20M
Programming cable	CMS-RS232*
USB to serial converter	CMS-USB*
Power supply 15W, 24V	DR-15-24
Power supply 30W, 24V	DR-30-24
PT100 / PT1000 amplifier	MV-LKM-274
Indoor temperature sensor with display, 0 ... 50 °C	CRF01-U-D
Indoor temperature sensor, 0 ... 50 °C	CRF01-U
Exterior temperature sensor, -50 ... +50 °C	CWF50-EXT-U4
Thermostat, 5 ... 30 °C	CRTBSB-001-010
Temperature / humidity sensor	KS-110
Water level sensor	PS1

**fig. 1. Wiring diagram****fig. 2. Dimensions (mm)****Standards and approvals**

Standards IEC/EN 60947, IEC/EN60730

Approvals 

CMS-10ACDF

4 analogue / digital inputs | 2 inputs 4 ... 20 mA | 4 relay outputs | 12 ... 48 V DC

Power supply	
Nominal voltage	12 ... 48 V DC
Operating voltage range	10 ... 60 V DC
Power consumption AC/DC	4.2 W

Inputs	
Number of analogue inputs	2
Number of analogue / digital inputs	4
Nominal voltage digital inputs	12 ... 48 V DC
Nominal range analogue inputs	0 ... 10 V (I1 - I4) / 4 ... 20 mA (I5 - I6)
Resolution of analogue inputs	10 Bit

Outputs	
Number of relay outputs	4
Contact Material	AgNi
Rated voltage	250 V AC
Rated current	10 A
Minimum contact load relay outputs	10 mA, 12V
Inrush current	15 A, 20 ms
Rated load AC-1	2500 VA
Mechanical endurance	3 x 10 ⁷
Electrical endurance at rated load AC-1	150 000

Communication	
Communication standards	GSM
Frequencies	850 / 900 / 1800 / 1900 MHz
Antenna connector	SMA female

Insulation	
Rated test voltage control / main circuit	2.5 kV, 1 min
Rated test voltage main / main circuit	2.5 kV, 1 min
Pollution degree	3
Overvoltage category	II

General data	
Ambient temperature storage	-40 ... 85 °C
Ambient temperature operation	-25 ... 55 °C
Conductor cross section	2.5 mm ²
Nominal screw torque	0.5 Nm
Weight	120 g
Protection degree	IP20
Housing material	PC

Product references		
Types	Product reference	12-48
DC supply	CMS-10ACDF/DC...V	✓
DC supply, kit (*included accessories)	CMS-10ACDFKIT/DC...V	✓

"..." list control circuit voltage to complete product references.

Accessories	
Antennas	CMS-ANT-SPEZ/5M, CMS-ANT-MAG/2.5M*
Antenna cables	CMS-ANT-KAB/5M, CMS-ANT-KAB/10M, CMS-ANT-KAB/20M
Programming cable	CMS-RS232*
USB to serial converter	CMS-USB*
Power supply 15W, 24V	DR-15-24
Power supply 30W, 24V	DR-30-24
PT100 / PT1000 amplifier	MV-LKM-274
Indoor temperature sensor with display, 0 ... 50 °C	CRF01-U-D
Indor temperature sensor, 0 ... 50 °C	CRF01-U
Exterior temperature sensor, -50 ... +50 °C	CWF50-EXT-U4
Thermostat, 5 ... 30 °C	CRTBSB-001-010
Temperature / humidity sensor	KS-110
Water level sensor	PS1



fig. 1. Wiring diagram

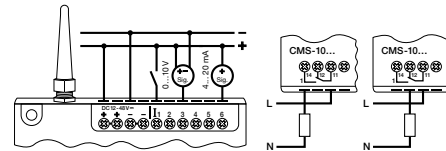
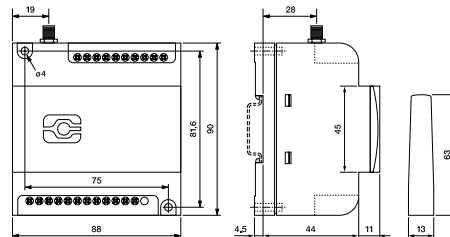


fig. 2. Dimensions (mm)



Standards and approvals

Standards IEC/EN 60947, IEC/EN60730

Approvals

5.2 CMS Accessories

Application	Type	Page
Accessories		
Exterior antenna 5 m cable	CMS-ANT-SPEZ/5M	312
Magnetic pod antenna 2.5 m cable	CMS-ANT-MAG/2.5M	313
Antenna cable SMA male / female 5 m 10 m 20 m	CMS-ANT-KAB	314
Programming cable Serial 1:1 D-Sub 9 male / female 2 m	CMS-RS232	315
USB to serial converter D-Sub 9 to USB A FTDI FT231XS	CMS-USB	316
Power supply 24 V DC 15 W 30 W	DR-15-24, DR-30-24	317
PT100 / PT1000 amplifier 0 ... 10 V output	MV-LKM-274	318
Indoor temperature sensor 0 ... 50 °C 0 ... 10 V output	RF01-U, RF01-U-D2	319
Thermostat 5 ... 30 °C Cooling or heating 1 CO	RTBSB-001-010	320
Exterior temperature sensor -50 ... 50 °C 0 ... 10 V output	WF50-EXT-U4	321
Temperature / humidity sensor -40 ... 80 °C 0 ... 100 % rH 0 ... 10 V output Cable length 2 m	KS-110	322
Water level sensor 0 ... 0.5 bar 0 ... 10 V output	PS1	323

CMS-ANT-SPEZ/5M

Exterior antenna | 5 m cable

Communication

Communication standards	GSM
Frequencies	824 ... 960 / 1710 ... 1990 MHz
Antenna connector	SMA male
Antenna type	1/4 _
Impedance	50 Ω
Max. power	20 W

General data

Ambient temperature storage	-30 °C ... 70 °C
Ambient temperature operation	-20 °C ... 60 °C
Weight	360 g
Housing material	RW24BR

Product references

Types	Product reference	5
Exterior antenna	CMS-ANT-SPEZ/...M	✓

"..." list cable length to complete product references.

**CMS-ANT-MAG/2.5M**

Magnetic pod antenna | 2.5 m cable

Communication

Communication standards	GSM / UMTS
Frequencies	824 / 960 / 1710 / 1910 / 1990 / 2010 / 2025 / 2110 / 2170 MHz
Antenna connector	SMA male
Antenna type	1/4 _
Impedance	50 Ω
Max. power	20 W

General data


Ambient temperature storage	-40 °C ... 80 °C
Ambient temperature operation	-40 °C ... 80 °C
Weight	65 g
Housing material	PA 6

Product references


Types	Product reference	2.5
Magnetic pod antenna	CMS-ANT-MAG/...M	✓

"..." list cable length to complete product references.

**Standards and approvals**

Approvals 

Standards and approvals

Approvals 

CMS-ANT-KAB

Antenna cable | SMA male / female | 5 m | 10 m | 20 m

Communication	
Antenna connector	SMA male / female
Impedance	50 Ω
General data	
Ambient temperature storage	-35 °C ... 80 °C
Ambient temperature operation	-35 °C ... 80 °C
Weight	180 g (5 m) / 270 g (10 m) / 728 g (20 m)
Housing material	Cu / PE

Product references

Types	Product reference	5	10	20
Extension cable SMA male / female	CMS-ANT-KAB/...M	✓	✓	✓

“...” list cable length to complete product references.
 Other cable length on request. Please contact support@comatreleco.com.



Standards and approvals

Approvals

CMS-RS232

Programming cable | Serial 1:1 | D-Sub 9 male / female | 2 m

General data	
Ambient temperature storage	-35 °C ... 80 °C
Ambient temperature operation	-35 °C ... 80 °C
Weight	126 g

Product references

Types	Product reference
Programming cable	CMS-RS232



Standards and approvals

Approvals

CMS-USB

USB to serial converter | D-Sub 9 to USB A | FTDI FT231XS

General data	
Ambient temperature storage	-40 °C ... 85 °C
Ambient temperature operation	-40 °C ... 85 °C
Weight	41 g

Product references	
Types	Product reference
USB to serial converter	CMS-USB



DR-15-24, DR-30-24

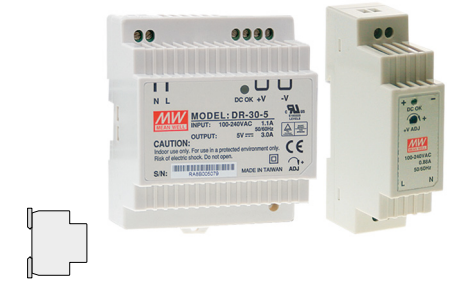
Power supply | 24 V DC | 15 W | 30 W

Power supply	
Nominal voltage	230 V AC
Operating voltage range	85 ... 264 V AC
Power consumption AC/DC	- / 110 VA
Rated frequency	47 ... 63 Hz
Output voltage	24 V DC
Output voltage range	21.6 ... 26.4 V
Output power	15 W 30 W

General data	
Ambient temperature storage	-40 °C ... 85 °C
Ambient temperature operation	-20 °C ... 60 °C
Conductor cross section	2.5 mm ²
Module width	fig. 1
Weight	65 g
Protection degree	IP20
Housing material	PA 6

Product references	
Types	Product reference
Power supply 15 W, 24 V DC	DR-15-24
Power supply 30 W, 24 V DC	DR-30-24

Other voltages on request. Please contact support@comatreleco.com.



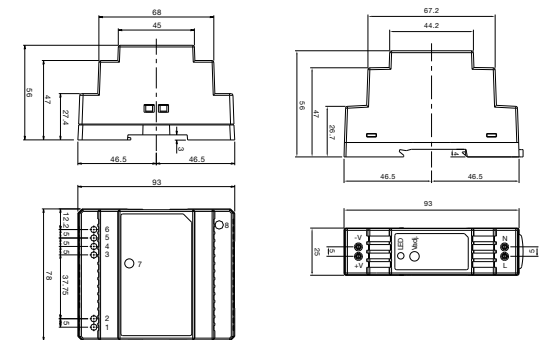
Standards and approvals

Approvals

Standards and approvals

Approvals

fig. 1. Dimensions (mm)



MV-LKM-274

PT100 / PT1000 amplifier | 0 ... 10 V output

Power supply	
Nominal voltage	24 V DC
Operating voltage range	15 ... 35 V DC
Power consumption AC/DC	0.24 W / -

Outputs	
Number of analogue outputs	1
Analogue output type	0 ... 10 V

General data	
Ambient temperature storage	-25 °C ... 70 °C
Ambient temperature operation	-25 °C ... 70 °C
Conductor cross section	2.5 mm ²
Module width	fig. 2
Weight	60 g
Protection degree	IP20
Housing material	PC

Product references	
Types	Product reference
PT100 / PT1000 amplifier	MV-LKM-274

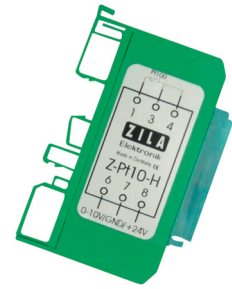


fig. 1. Wiring diagram

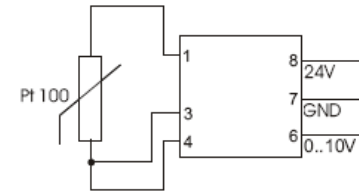
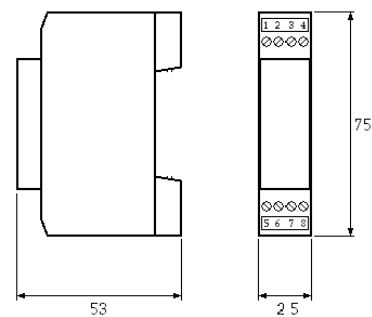


fig. 2. Dimensions (mm)



Standards and approvals

Approvals

RF01-U, RF01-U-D2

Indoor temperature sensor | 0 ... 50 °C | 0 ... 10 V output

Power supply	
Nominal voltage	24 V UC
Operating voltage range	22 ... 26 V UC
Power consumption AC/DC	0.2 W / -

Outputs	
Number of analogue outputs	1
Analogue output type	0 ... 10 V

General data	
Ambient temperature storage	-20 °C ... 60 °C
Ambient temperature operation	-20 °C ... 60 °C
Conductor cross section	1.5 mm ²
Module width	fig. 2
Weight	67 g
Protection degree	IP54
Housing material	ABS

Product references	
Types	Product reference
Indoor temperature sensor	RF01-U
Indoor temperature sensor with display	RF01-U-D2



fig. 1. Wiring diagram

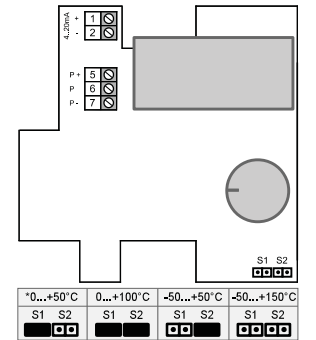
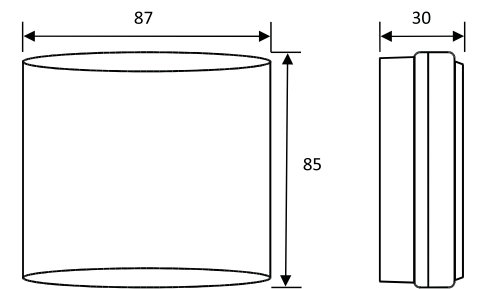


fig. 2. Dimensions (mm)



Standards and approvals

Approvals

RTBSB-001-010

Thermostat | 5 ... 30 °C | Cooling or heating | 1 CO

Outputs

Number of relay outputs	1 CO
Rated voltage	230 V AC
Rated current	10 A (Terminal 1) / 5 A (Terminal 3)
Rated load AC-1	2300 VA / 1150 VA

General data

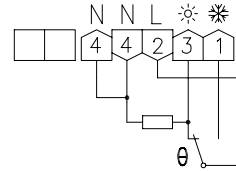
Ambient temperature storage	-20 °C ... 60 °C
Ambient temperature operation	-20 °C ... 60 °C
Conductor cross section	1.5 mm ²
Weight	90 g
Protection degree	IP30
Housing material	ABS

Product references

Types	Product reference
Thermostat	RTBSB-001-010



fig. 1. Wiring diagram



Standards and approvals

Approvals

WF50-EXT-U4

Exterior temperature sensor | -50 ... 50 °C | 0 ... 10 V output

Power supply

Nominal voltage	24 V DC
Operating voltage range	21.6 ... 26.4 V DC

Outputs

Number of analogue outputs	1
Analogue output type	0 ... 10 V

General data

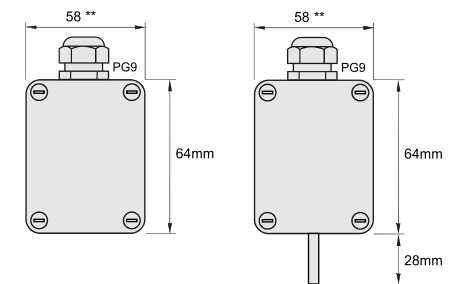
Ambient temperature storage	-30 °C ... 70 °C
Ambient temperature operation	-30 °C ... 70 °C
Conductor cross section	1.5 mm ²
Module width	fig. 2
Weight	100 g
Protection degree	IP65
Housing material	PA

Product references

Types	Product reference
Exterior temperature sensor	WF50-EXT-U4



fig. 2. Dimensions (mm)



Standards and approvals

Approvals

KS-110**Temperature / humidity sensor | -40 ... 80 °C | 0 ... 100 % rH | 0 ... 10 V output | Cable length 2 m****Power supply**

Nominal voltage	24 V DC
Operating voltage range	12 ... 27 V DC
Power consumption AC/DC	0.2 W / -

Outputs

Number of analogue outputs	2
Analogue output type	0 ... 10 V

General data

Ambient temperature storage	-40 °C ... 85 °C
Ambient temperature operation	-40 °C ... 85 °C
Weight	62 g
Protection degree	IP65

Product references

Types	Product reference
Temperature / humidity sensor	KS-110

**PS1****Water level sensor | 0 ... 0.5 bar | 0 ... 10 V output****Power supply**

Nominal voltage	24 V DC
Operating voltage range	12 ... 30 V DC

Outputs

Number of analogue outputs	1
Analogue output type	0 ... 10 V



General data

Ambient temperature storage	5 °C ... 70 °C
Ambient temperature operation	5 °C ... 70 °C
Weight	550 g
Protection degree	IP68

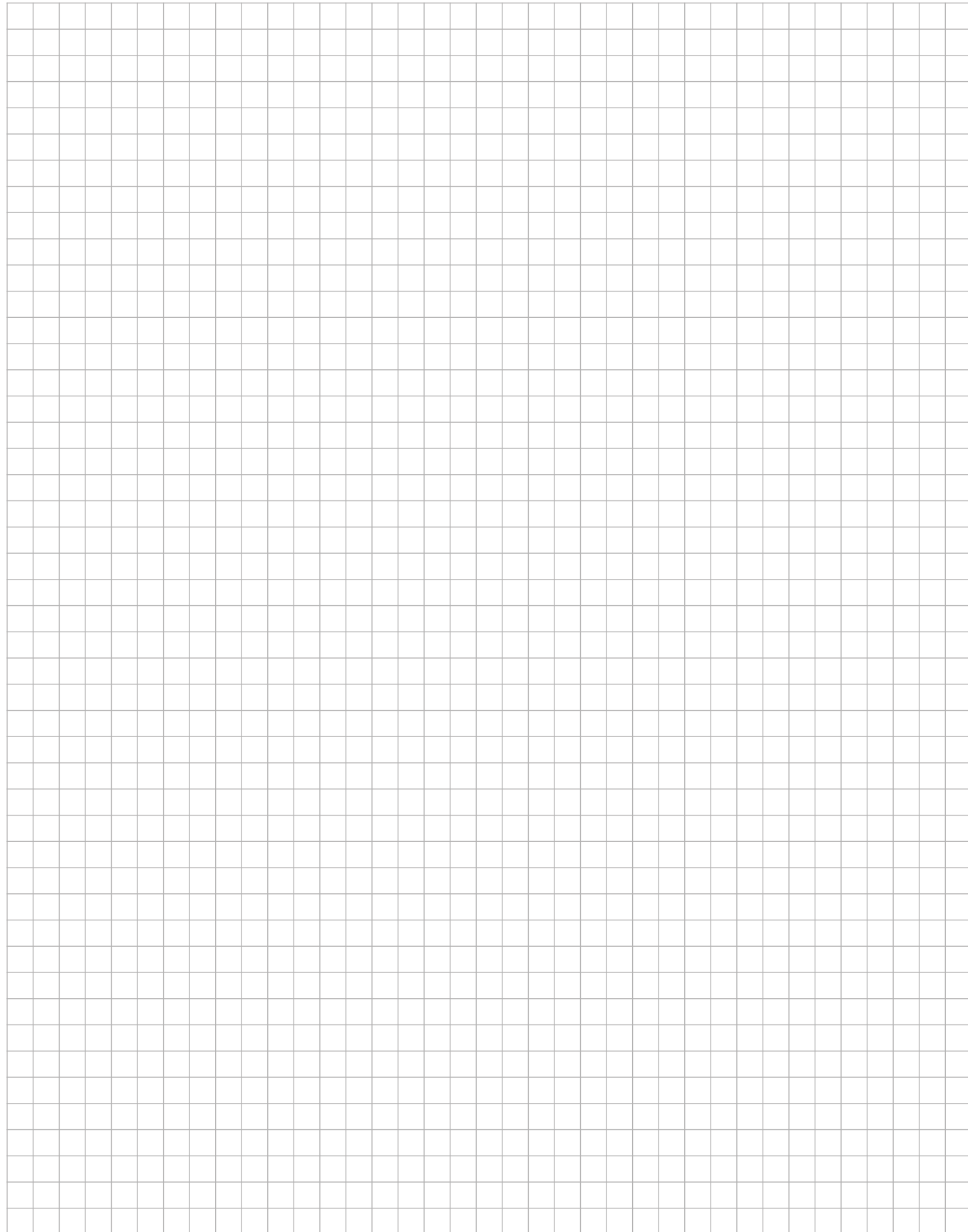
Product references

Types	Product reference
Water level sensor	PS1

Sensors for other liquids on request. Please contact support@comatreleco.com.

**Standards and approvals**Approvals **Standards and approvals**Approvals 

Notes



6.1 Softstarter

Application	Type	Page
CTC Series		
Starting Torque Limiter 3 phase 400 V 15 A	CTC3415	328
Starting Torque Limiter 3 phase 400 V 25 A	CTC3425	329
CCL Series		
Compressor Starting Torque Limiter 3 phase 400 V 15 A	CCL33H415US	330
Compressor Starting Torque Limiter 3 phase 400 V 25 A	CCL33H425US	331
Compressor Starting Torque Limiter 3 phase 400 V 35 A	CCL33H435US	332
CCM Series		
Starting Torque Limiter 3 phase 400 V 3 A	CCM3H403USi	333
Starting Torque Limiter 3 phase 400 V 15 A	CCM3H415	334
Starting Torque Limiter 3 phase 400 V 15 A	CCM3H415DS	335
Starting Torque Limiter 3 phase 400 V 25 A	CCM3H425	336
Starting Torque Limiter 3 phase 480 V 25 A	CCM33H425US	337
Starting Torque Limiter 3 phase 480 V 50 A	CCM33H450US	338
Starting Torque Limiter 3 phase 480 V 30 A	CCM33H530USi	339
Starting Torque Limiter 3 phase 480 V 50 A	CCM33H550USi	340
Starting Torque Limiter with dynamic brake 3 phase 400 V 25 A	CCMB3H425	341
Accessories		
Thermal overload protection	P82-100C	342

CTC3415

Starting Torque Limiter | 3 phase | 400 V | 15 A

Main circuit	
Number of outputs	3
Controlled phases	1
Output type	⚡ Thyristor
Rated voltage	400 V
Output voltage range	208 ... 400 V AC
Reverse voltage	1200 V _{rrm}
Peak reverse voltage	1300 V _{rrm}
Rated current AC-53a	15 A
Minimum load	50 mA
Typ. leakage current	5 mA
Rated limit load	1800 A ² t
Switching cycles / h	3000

Control circuit	
Release time	1 Periode
Ramp-up time	0.5 ... 5 s
Torque adjustment	0 ... 85 %
Rated frequency	50 / 60 Hz

Insulation	
Rated insulation voltage	660 V
Rated impulse withstand voltage	4 kV
Pollution degree	3
Overvoltage category	III

General data	
Ambient temperature storage	-20 ... 80 °C
Ambient temperature operation	-5 ... 40 °C
Ambient temperature operation derated power	-5 ... 60 °C, 0.7 I _N
Conductor cross section Control / Main Circuit	1.5 mm ² / 4 mm ²
Nominal screw torque Control / Main Circuit	0.5 Nm / 1.2 Nm
Module width	fig. 2
Weight	650 g
Protection degree	IP 20
Housing material	PPO
Mounting	TS 35 or Back Panel Mounting

Product references

Description	Product reference
Starting Torque Limiter, 3 phase	CTC3415

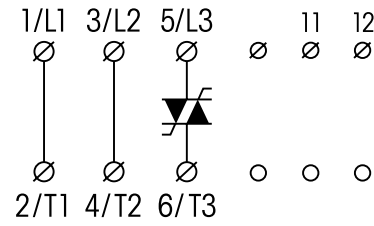
Other devices on request. Please contact support@comatreleco.com.

Accessories

Thermostat	P82-100C
------------	----------

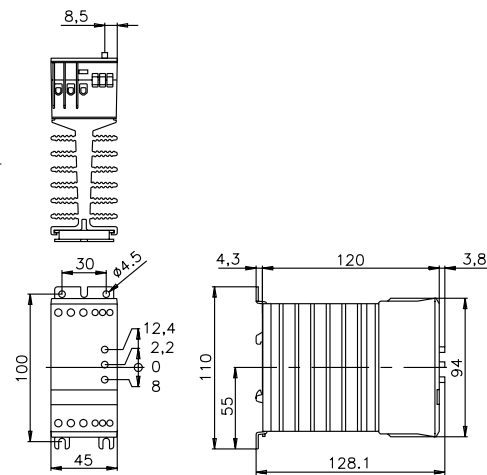


fig. 1. Wiring diagram



11-12: Thermostat

fig. 2. Dimensions (mm)



Standards and approvals

Standards IEC/EN 60947, 60068-2-6



CTC3425

Starting Torque Limiter | 3 phase | 400 V | 25 A

Main circuit	
Number of outputs	3
Controlled phases	1
Output type	⚡ Thyristor
Rated voltage	400 V
Output voltage range	208 ... 400 V AC
Reverse voltage	1200 V _{rrm}
Peak reverse voltage	1300 V _{rrm}
Rated current AC-53a	25 A
Minimum load	50 mA
Typ. leakage current	5 mA
Rated limit load	6300 A ² t
Switching cycles / h	3000

Control circuit	
Release time	1 Periode
Ramp-up time	0.5 ... 5 s
Torque adjustment	0 ... 85 %
Rated frequency	50 / 60 Hz

Insulation	
Rated insulation voltage	660 V
Rated impulse withstand voltage	4 kV
Pollution degree	3
Overvoltage category	III

General data	
Ambient temperature storage	-20 ... 80 °C
Ambient temperature operation	-5 ... 40 °C
Ambient temperature operation derated power	-5 ... 60 °C, 0.7 I _N
Conductor cross section Control / Main Circuit	1.5 mm ² / 4 mm ²
Nominal screw torque Control / Main Circuit	0.5 Nm / 1.2 Nm
Module width	fig. 2
Weight	650 g
Protection degree	IP 20
Housing material	PPO
Mounting	TS 35 or Back Panel Mounting

Product references

Description	Product reference
Starting Torque Limiter, 3 phase	CTC3425

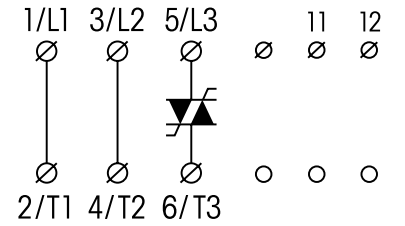
Other devices on request. Please contact support@comatreleco.com.

Accessories

Thermostat	P82-100C
------------	----------

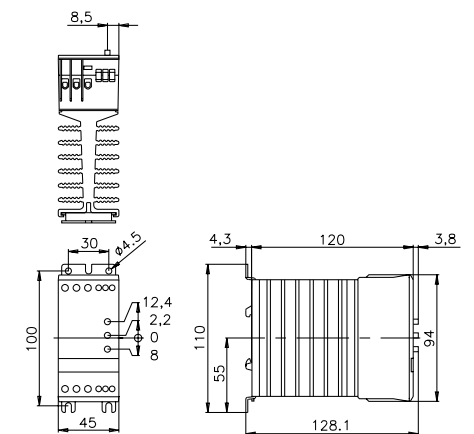


fig. 1. Wiring diagram



11-12: Thermostat

fig. 2. Dimensions (mm)



Standards and approvals

Standards IEC/EN 60947, 60068-2-6



6.1 Softstarter
CCL33H415US

Compressor Starting Torque Limiter | 3 phase | 400 V | 15 A

Main circuit	
Number of outputs	3
Controlled phases	3
Output type	⚡ Thyristor
Bypass	Integrated
Rated voltage	400 V
Output voltage range	230 ... 400 V AC
Reverse voltage	1200 V _{rrm}
Peak reverse voltage	1300 V _{rrm}
Rated current AC-58	15 A
Minimum load	1.5 A
Typ. leakage current	5 mA
Inrush current	90 A, 1 s
Rated limit load	610 A ^{2t}
Switching cycles / h	12

Control circuit	
Nominal voltage	230 V AC
Operating voltage range	0.85 ... 1.15 U _N
Typ. release voltage	110 V AC
Pick-up time	500 ms
Release time	500 ms

Insulation	
Rated insulation voltage	660 V
Rated impulse withstand voltage	4 kV
Pollution degree	3
Overvoltage category	III

General data	
Ambient temperature storage	-20 ... 80 °C
Ambient temperature operation	-20 ... 65 °C
Conductor cross section Control / Main Circuit	2.5 mm ² / 6 mm ²
Module width	fig. 2
Weight	470 g
Protection degree	IP 20
Housing material	PPE
Mounting	TS 35 or Back Panel Mounting

Product references

Description	Product reference
Compressor Starting Torque Limiter, 3 phase	CCL33H415US

Other devices on request. Please contact support@comatreleco.com.



fig. 1. Wiring diagram

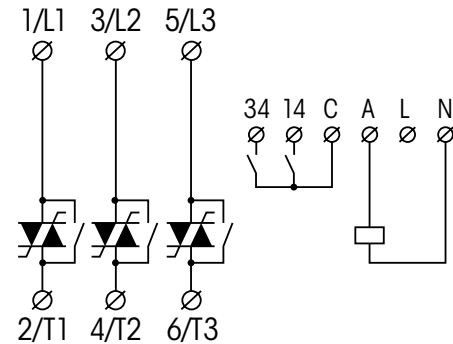
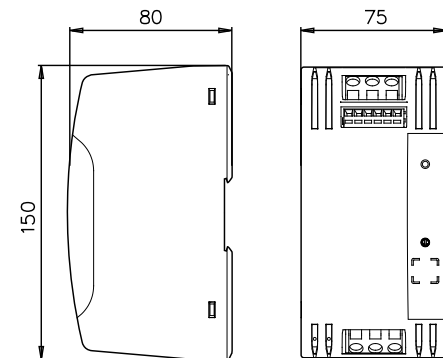


fig. 2. Dimensions (mm)



Standards and approvals

Standards IEC/EN 60947
 Approvals CE cULus

6.1 Softstarter
CCL33H425US

Compressor Starting Torque Limiter | 3 phase | 400 V | 25 A

Main circuit	
Number of outputs	3
Controlled phases	3
Output type	⚡ Thyristor
Bypass	Integrated
Rated voltage	400 V
Output voltage range	230 ... 400 V AC
Reverse voltage	1200 V _{rrm}
Peak reverse voltage	1300 V _{rrm}
Rated current AC-58	25 A
Minimum load	2.5 A
Typ. leakage current	5 mA
Inrush current	150 A, 1 s
Rated limit load	1800 A ^{2t}
Switching cycles / h	12

Control circuit	
Nominal voltage	230 V AC
Operating voltage range	0.85 ... 1.15 U _N
Typ. release voltage	110 V AC
Pick-up time	500 ms
Release time	500 ms

Insulation	
Rated insulation voltage	660 V
Rated impulse withstand voltage	4 kV
Pollution degree	3
Overvoltage category	III

General data	
Ambient temperature storage	-20 ... 80 °C
Ambient temperature operation	-20 ... 65 °C
Conductor cross section Control / Main Circuit	2.5 mm ² / 6 mm ²
Module width	fig. 2
Weight	470 g
Protection degree	IP 20
Housing material	PPE
Mounting	TS 35 or Back Panel Mounting

Product references

Description	Product reference
Compressor Starting Torque Limiter, 3 phase	CCL33H425US

Other devices on request. Please contact support@comatreleco.com.



fig. 1. Wiring diagram

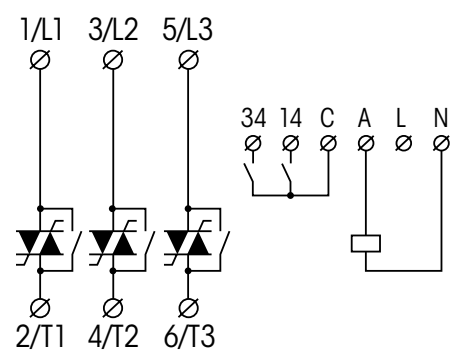
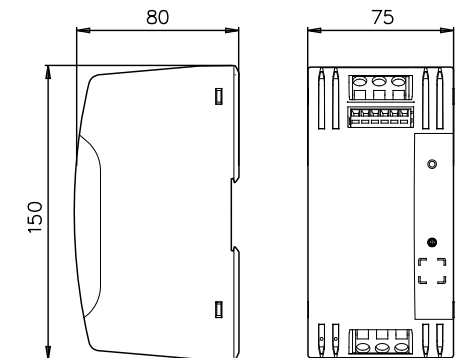


fig. 2. Dimensions (mm)



Standards and approvals

Standards IEC/EN 60947
 Approvals CE cULus

6.1 Softstarter

CCL33H435US

Compressor Starting Torque Limiter | 3 phase | 400 V | 35 A

Main circuit	
Number of outputs	3
Controlled phases	3
Output type	⚡ Thyristor
Bypass	Integrated
Rated voltage	400 V
Output voltage range	230 ... 400 V AC
Reverse voltage	1200 V _{rrm}
Peak reverse voltage	1300 V _{rrm}
Rated current AC-58	35 A
Minimum load	3.5 A
Typ. leakage current	5 mA
Inrush current	210 A, 1 s
Rated limit load	1800 A ² t
Switching cycles / h	12

Control circuit	
Nominal voltage	230 V AC
Operating voltage range	0.85 ... 1.15 U _n
Typ. release voltage	110 V AC
Pick-up time	500 ms
Release time	500 ms

Insulation	
Rated insulation voltage	660 V
Rated impulse withstand voltage	4 kV
Pollution degree	3
Overvoltage category	III

General data	
Ambient temperature storage	-20 ... 80 °C
Ambient temperature operation	-20 ... 65 °C
Conductor cross section Control / Main Circuit	2.5 mm ² / 6 mm ²
Module width	fig. 2
Weight	470 g
Protection degree	IP 20
Housing material	PPE
Mounting	TS 35 or Back Panel Mounting

Product references

Description	Product reference
Compressor Starting Torque Limiter, 3 phase	CCL33H435US

Other devices on request. Please contact support@comatreleco.com.



fig. 1. Wiring diagram

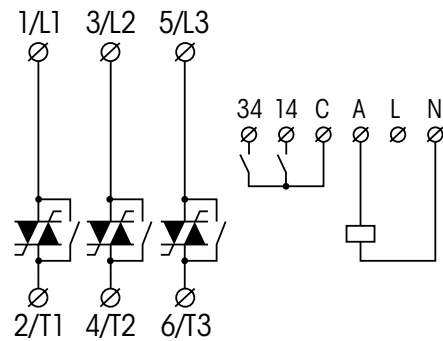
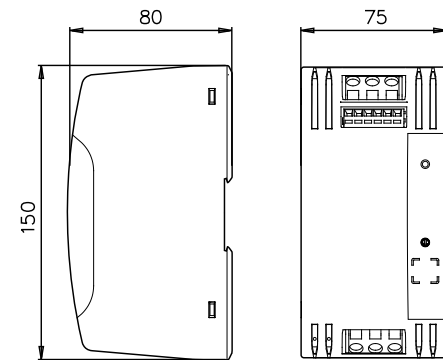


fig. 2. Dimensions (mm)



Standards and approvals

Standards IEC/EN 60947

Approvals CE cULus

6.1 Softstarter

CCM3H403USi

Starting Torque Limiter | 3 phase | 400 V | 3 A

Main circuit	
Number of outputs	3
Controlled phases	2
Output type	⚡ Thyristor
Bypass	Integrated
Rated voltage	400 V
Output voltage range	400 ... 480 V AC
Reverse voltage	1200 V _{rrm}
Peak reverse voltage	1300 V _{rrm}
Rated current AC-53b	3 A
Minimum load	250 mA
Typ. leakage current	5 mA
Inrush current	18 A
Rated limit load	72 A ² t
Switching cycles / h	120

Control circuit	
Nominal voltage	400 V AC
Ramp-up time	0.5 ... 10 s
Ramp-down time	0.5 ... 10 s
Torque adjustment	0 ... 85 %
Rated frequency	50 / 60 Hz

Insulation	
Rated insulation voltage	660 V
Rated impulse withstand voltage	4 kV
Pollution degree	3
Overvoltage category	III

General data	
Ambient temperature storage	-20 ... 80 °C
Ambient temperature operation	-5 ... 40 °C
Ambient temperature operation derated power	-5 ... 60 °C
Conductor cross section Control / Main Circuit	2.5 mm ² / 4 mm ²
Nominal screw torque Control / Main Circuit	0.5 Nm / 1.2 Nm
Module width	fig. 2
Weight	270 g
Protection degree	IP 20
Housing material	PPO
Mounting	TS 35 or Back Panel Mounting

Product references

Description	Product reference
Starting Torque Limiter, 3 phase	CCM3H403USi

Other devices on request. Please contact support@comatreleco.com.



fig. 1. Wiring diagram

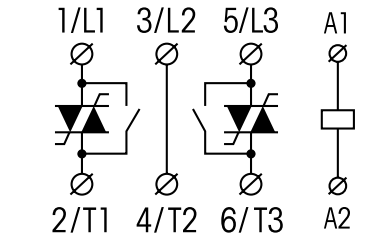
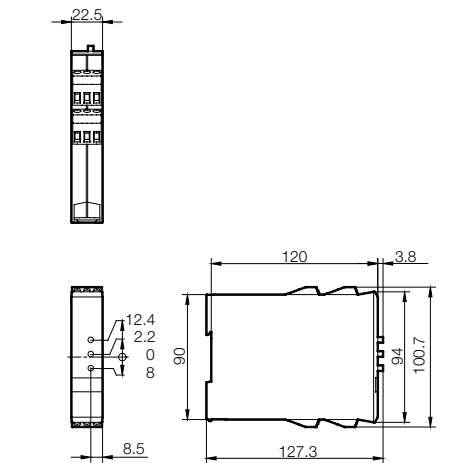


fig. 2. Dimensions (mm)



Standards and approvals

Standards IEC/EN 60947, 60068

Approvals CE cULus

6.1 Softstarter

CCM3H415

Starting Torque Limiter | 3 phase | 400 V | 15 A

Main circuit	
Number of outputs	3
Controlled phases	2
Output type	Thyristor
Rated voltage	400 V
Output voltage range	400 ... 480 V AC
Reverse voltage	1200 V _{rrm}
Peak reverse voltage	1300 V _{rrm}
Rated current AC-53b	15 A
Minimum load	250 mA
Typ. leakage current	5 mA
Inrush current	90 A
Rated limit load	1800 A ² t
Switching cycles / h	3000

Control circuit	
Nominal voltage	400 V AC
Ramp-up time	0.5 ... 10 s
Ramp-down time	0.5 ... 10 s
Torque adjustment	0 ... 85 %
Rated frequency	50 / 60 Hz

Insulation	
Rated insulation voltage	660 V
Rated impulse withstand voltage	4 kV
Pollution degree	3
Overvoltage category	III

General data	
Ambient temperature storage	-20 ... 80 °C
Ambient temperature operation	-5 ... 40 °C
Ambient temperature operation derated power	-5 ... 60 °C
Conductor cross section Control / Main Circuit	2.5 mm ² / 4 mm ²
Nominal screw torque Control / Main Circuit	0.5 Nm / 1.2 Nm
Module width	fig. 2
Weight	650 g
Protection degree	IP 20
Housing material	PPO
Mounting	TS 35 or Back Panel Mounting

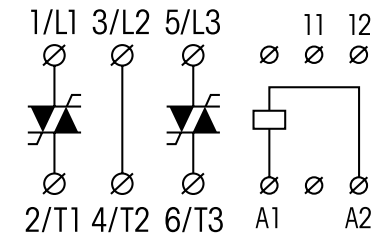
Product references	
Description	Product reference
Starting Torque Limiter, 3 phase	CCM3H415

Other devices on request. Please contact support@comatreleco.com.

Accessories	
Thermal overload protection	P82-100C

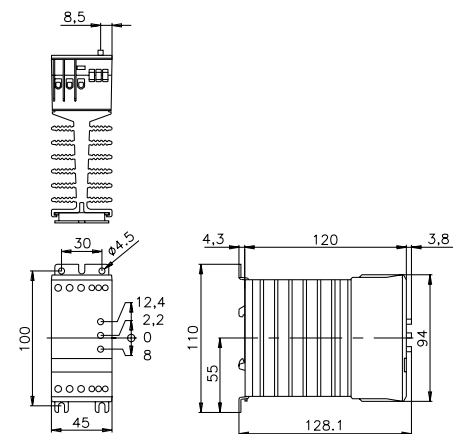


fig. 1. Wiring diagram



11-12: Thermostat

fig. 2. Dimensions (mm)



Standards and approvals

Standards IEC/EN 60947, 60068



6.1 Softstarter

CCM3H415DS

Starting Torque Limiter | 3 phase | 400 V | 15 A

Main circuit	
Number of outputs	3
Controlled phases	2
Output type	Thyristor
Rated voltage	400 V
Output voltage range	400 ... 480 V AC
Reverse voltage	1200 V _{rrm}
Peak reverse voltage	1300 V _{rrm}
Rated current AC-53b	15 A
Minimum load	250 mA
Typ. leakage current	5 mA
Inrush current	90 A
Rated limit load	1800 A ² t
Switching cycles / h	3000

Control circuit	
Nominal voltage	400 V AC
Ramp-up time	0.5 ... 10 s
Ramp-down time	0.5 ... 10 s
Torque adjustment	0 ... 85 %
Rated frequency	50 / 60 Hz

Insulation	
Rated insulation voltage	660 V
Rated impulse withstand voltage	4 kV
Pollution degree	3
Overvoltage category	III

General data	
Ambient temperature storage	-20 ... 80 °C
Ambient temperature operation	-5 ... 40 °C
Ambient temperature operation derated power	-5 ... 60 °C
Conductor cross section Control / Main Circuit	2.5 mm ² / 4 mm ²
Nominal screw torque Control / Main Circuit	0.5 Nm / 1.2 Nm
Module width	fig. 2
Weight	650 g
Protection degree	IP 20
Housing material	PPO
Mounting	TS 35 or Back Panel Mounting

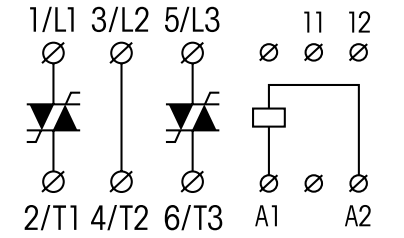
Product references	
Description	Product reference
Starting Torque Limiter, 3 phase	CCM3H415DS

Other devices on request. Please contact support@comatreleco.com.

Accessories	
Thermal overload protection	P82-100C

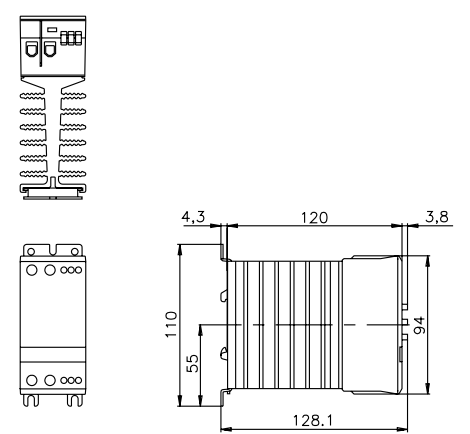


fig. 1. Wiring diagram



11-12: Thermostat

fig. 2. Dimensions (mm)



Standards and approvals

Standards IEC/EN 60947, 60068



6.1 Softstarter

CCM3H425

Starting Torque Limiter | 3 phase | 400 V | 25 A

Main circuit	
Number of outputs	3
Controlled phases	2
Output type	Thyristor
Rated voltage	400 V
Output voltage range	400 ... 480 V AC
Reverse voltage	1200 V _{rrm}
Peak reverse voltage	1300 V _{rrm}
Rated current AC-53b	25 A
Minimum load	250 mA
Typ. leakage current	5 mA
Inrush current	150 A
Rated limit load	6300 A ² t
Switching cycles / h	3000

Control circuit	
Nominal voltage	400 V AC
Ramp-up time	0.5 ... 10 s
Ramp-down time	0.5 ... 10 s
Torque adjustment	0 ... 85 %
Rated frequency	50 / 60 Hz

Insulation	
Rated insulation voltage	660 V
Rated impulse withstand voltage	4 kV
Pollution degree	3
Overvoltage category	III

General data	
Ambient temperature storage	-20 ... 80 °C
Ambient temperature operation	-5 ... 40 °C
Ambient temperature operation derated power	-5 ... 60 °C
Conductor cross section Control / Main Circuit	2.5 mm ² / 6 mm ²
Nominal screw torque Control / Main Circuit	0.5 Nm / 1.2 Nm
Module width	fig. 2
Weight	1050 g
Protection degree	IP 20
Housing material	PPO
Mounting	TS 35 or Back Panel Mounting

Product references

Description	Product reference
Starting Torque Limiter, 3 phase	CCM3H425

Other devices on request. Please contact support@comatreleco.com.

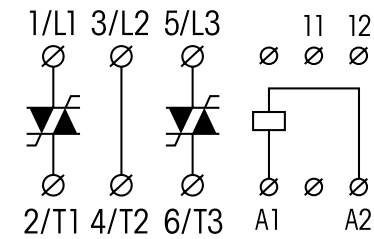
Accessories

Thermal overload protection	P82-100C
-----------------------------	----------

comat
RELECO

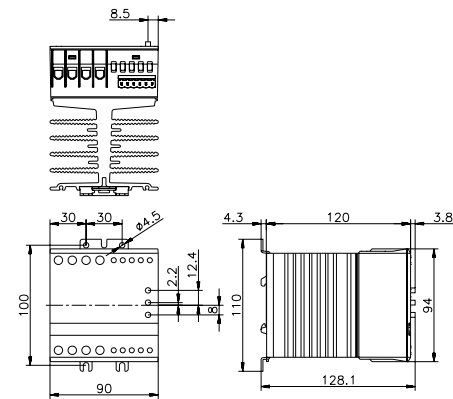


fig. 1. Wiring diagram



11-12: Thermostat

fig. 2. Dimensions (mm)



Standards and approvals

Standards IEC/EN 60947, 60068

Approvals

6.1 Softstarter

CCM33H425US

Starting Torque Limiter | 3 phase | 480 V | 25 A

Main circuit	
Number of outputs	3
Controlled phases	3
Output type	Thyristor
Bypass	Externally
Rated voltage	400 V
Output voltage range	200 ... 480 V AC
Reverse voltage	1200 V _{rrm}
Peak reverse voltage	1300 V _{rrm}
Rated current AC-53b	25 A
Minimum load	3 A
Typ. leakage current	5 mA
Inrush current	150 A, 450 ms
Rated limit load	6300 A ² t
Switching cycles / h	120

Control circuit	
Nominal voltage	480 V AC
Operating voltage range	24 - 230 V UC
Typ. release voltage	5 V UC
Ramp-up time	0.5 ... 30 s
Ramp-down time	0.5 ... 60 s
Torque adjustment	0 ... 85 %
Rated frequency	50 / 60 Hz

Insulation	
Rated insulation voltage	660 V
Rated impulse withstand voltage	4 kV
Pollution degree	3
Overvoltage category	III

General data	
Ambient temperature storage	-20 ... 80 °C
Ambient temperature operation	-5 ... 40 °C
Ambient temperature operation derated power	-5 ... 60 °C
Conductor cross section Control / Main Circuit	2.5 mm ² / 6 mm ²
Nominal screw torque Control / Main Circuit	0.5 Nm / 1.2 Nm
Module width	fig. 2
Weight	1050 g
Protection degree	IP 20
Housing material	PPE
Mounting	TS 35 or Back Panel Mounting

Product references

Description	Product reference
Starting Torque Limiter, 3 phase	CCM33H425US

Other devices on request. Please contact support@comatreleco.com.

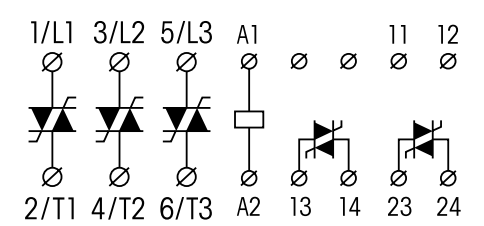
Accessories

Thermal overload protection	P82-100C
-----------------------------	----------

comat
RELECO



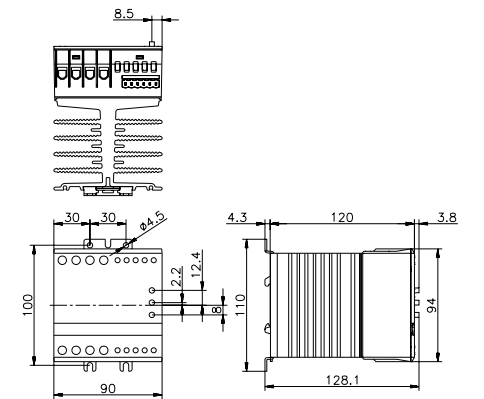
fig. 1. Wiring diagram



11-12: Thermostat

13-14: For control of Start/Stop function
23-24: By end of ramp up time for by-pass contactor

fig. 2. Dimensions (mm)



Standards and approvals

Standards IEC/EN 60947, 50022, 60068

Approvals

6.1 Softstarter
CCM33H450US

Starting Torque Limiter | 3 phase | 480 V | 50 A

Main circuit	
Number of outputs	3
Controlled phases	3
Output type	Thyristor
Bypass	Externally
Rated voltage	400 V
Output voltage range	200 ... 480 V AC
Reverse voltage	1200 V _{rrm}
Peak reverse voltage	1300 V _{rrm}
Rated current AC-53b	50 A
Minimum load	3 A
Typ. leakage current	5 mA
Inrush current	300 A, 450 ms
Rated limit load	25300 A ² t
Switching cycles / h	120

Control circuit	
Nominal voltage	480 V AC
Operating voltage range	24 - 230 V UC
Typ. release voltage	5 V UC
Ramp-up time	0.5 ... 30 s
Ramp-down time	0.5 ... 60 s
Torque adjustment	0 ... 85 %
Rated frequency	50 / 60 Hz

Insulation	
Rated insulation voltage	660 V
Rated impulse withstand voltage	4 kV
Pollution degree	3
Overvoltage category	III

General data	
Ambient temperature storage	-20 ... 80 °C
Ambient temperature operation	-5 ... 40 °C
Ambient temperature operation derated power	-5 ... 60 °C
Conductor cross section Control / Main Circuit	2.5 mm ² / 6 mm ²
Nominal screw torque Control / Main Circuit	0.5 Nm / 1.2 Nm
Module width	fig. 2
Weight	2500 g
Protection degree	IP 20
Housing material	PPE
Mounting	TS 35 or Back Panel Mounting

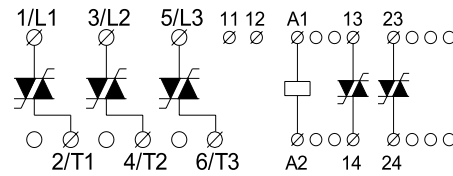
Product references	
Description	Product reference
Starting Torque Limiter, 3 phase	CCM33H450US

Other devices on request. Please contact support@comatreleco.com.

Accessories	
Thermal overload protection	P82-100C

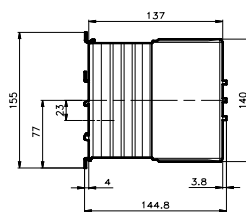
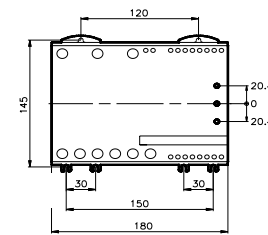


fig. 1. Wiring diagram



11-12: Thermostat
13-14: For control of Start/Stop function
23-24: By end of ramp up time for by-pass contactor

fig. 2. Dimensions (mm)



Standards and approvals

Standards IEC/EN 60947, 50022, 60068



6.1 Softstarter
CCM33H530USi

Starting Torque Limiter | 3 phase | 480 V | 30 A

Main circuit	
Number of outputs	3
Controlled phases	3
Output type	Thyristor
Bypass	Externally
Rated voltage	400 V
Output voltage range	200 ... 480 V AC
Reverse voltage	1200 V _{rrm}
Peak reverse voltage	1300 V _{rrm}
Rated current AC-53b	30 A
Minimum load	3 A
Typ. leakage current	5 mA
Inrush current	180 A, 450 ms
Rated limit load	6300 A ² t
Switching cycles / h	120

Control circuit	
Nominal voltage	480 V AC
Operating voltage range	24 - 230 V UC
Typ. release voltage	5 V UC
Ramp-up time	0.5 ... 30 s
Ramp-down time	0.5 ... 60 s
Torque adjustment	0 ... 85 %
Rated frequency	50 / 60 Hz

Insulation	
Rated insulation voltage	660 V
Rated impulse withstand voltage	4 kV
Pollution degree	3
Overvoltage category	III

General data	
Ambient temperature storage	-20 ... 80 °C
Ambient temperature operation	-5 ... 40 °C
Ambient temperature operation derated power	-5 ... 60 °C
Conductor cross section Control / Main Circuit	2.5 mm ² / 6 mm ²
Nominal screw torque Control / Main Circuit	0.5 Nm / 1.2 Nm
Module width	fig. 2
Weight	1050 g
Protection degree	IP 20
Housing material	PPE
Mounting	TS 35 or Back Panel Mounting

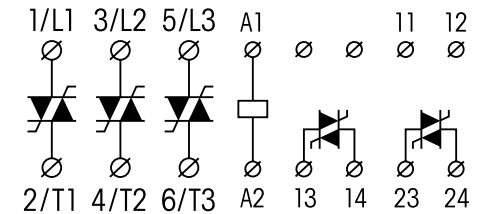
Product references	
Description	Product reference
Starting Torque Limiter, 3 phase	CCM33H530USi

Other devices on request. Please contact support@comatreleco.com.

Accessories	
Thermal overload protection	P82-100C

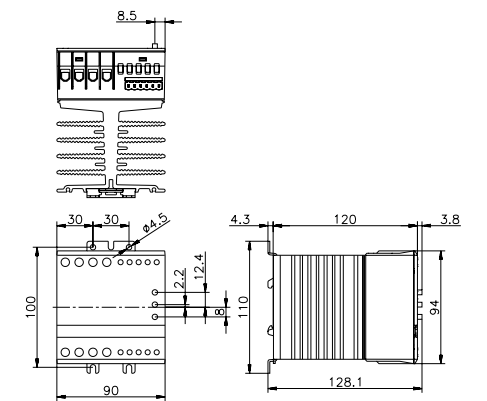


fig. 1. Wiring diagram



11-12: Thermostat
13-14: For control of Start/Stop function
23-24: By end of ramp up time for by-pass contactor

fig. 2. Dimensions (mm)



Standards and approvals

Standards IEC/EN 60947, 50022, 60068



6.1 Softstarter
CCM33H550USi

Starting Torque Limiter | 3 phase | 480 V | 50 A

Main circuit	
Number of outputs	3
Controlled phases	3
Output type	Thyristor
Bypass	Externally
Rated voltage	400 V
Output voltage range	200 ... 480 V AC
Reverse voltage	1200 V _{rrm}
Peak reverse voltage	1300 V _{rrm}
Rated current AC-53b	50 A
Minimum load	3 A
Typ. leakage current	5 mA
Inrush current	300 A, 450 ms
Rated limit load	25300 A ² t
Switching cycles / h	120

Control circuit	
Nominal voltage	480 V AC
Operating voltage range	24 - 230 V UC
Typ. release voltage	5 V UC
Ramp-up time	0.5 ... 30 s
Ramp-down time	0.5 ... 60 s
Torque adjustment	0 ... 85 %
Rated frequency	50 / 60 Hz

Insulation	
Rated insulation voltage	660 V
Rated impulse withstand voltage	4 kV
Pollution degree	3
Overtoltage category	III

General data	
Ambient temperature storage	-20 ... 80 °C
Ambient temperature operation	-5 ... 40 °C
Ambient temperature operation derated power	-5 ... 60 °C
Conductor cross section Control / Main Circuit	2.5 mm ² / 6 mm ²
Nominal screw torque Control / Main Circuit	0.5 Nm / 1.2 Nm
Module width	fig. 2
Weight	2500 g
Protection degree	IP 20
Housing material	PPE
Mounting	TS 35 or Back Panel Mounting

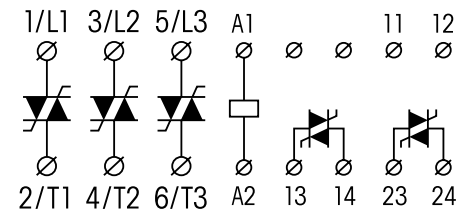
Product references	
Description	Product reference
Starting Torque Limiter, 3 phase	CCM33H550USi

Other devices on request. Please contact support@comatreleco.com.

Accessories	
Thermal overload protection	P82-100C

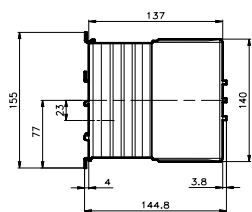
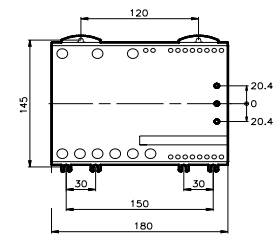


fig. 1. Wiring diagram



11-12: Thermostat
13-14: For control of Start/Stop function
23-24: By end of ramp up time for by-pass contactor

fig. 2. Dimensions (mm)



Standards and approvals

Standards IEC/EN 60947, 50022, 60068



6.1 Softstarter
CCMB3H425

Starting Torque Limiter with dynamic brake | 3 phase | 400 V | 25 A

Main circuit	
Number of outputs	3
Controlled phases	2
Output type	Thyristor
Bypass	Externally
Rated voltage	400 V
Output voltage range	400 ... 480 V AC
Reverse voltage	1600 V _{rrm}
Peak reverse voltage	1650 V _{rrm}
Rated current AC-53a	25 A
Minimum load	1 A
Typ. leakage current	5 mA
Inrush current	200 A
Rated limit load	6300 A ² t

Control circuit	
Nominal voltage	480 V AC
Operating voltage range	24 - 230 V UC
Typ. release voltage	5 V UC
Pick-up time	100 ms
Release time	100 ms
Ramp-up time	0.5 ... 10 s
Brake current	0 ... 50 A
Torque adjustment	0 ... 85 %
Rated frequency	50 / 60 Hz

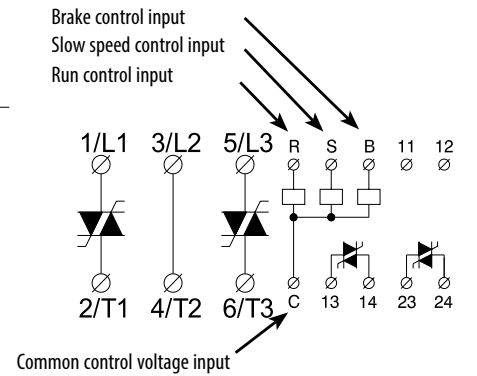
Insulation	
Pollution degree	3
Overtoltage category	III

General data	
Ambient temperature storage	-20 ... 80 °C
Ambient temperature operation	-5 ... 40 °C
Ambient temperature operation derated power	-5 ... 60 °C
Conductor cross section Control / Main Circuit	2.5 mm ² / 6 mm ²
Module width	fig. 2
Weight	1050 g
Protection degree	IP 20
Housing material	PPE
Mounting	TS 35 or Back Panel Mounting

Product references	
Description	Product reference
Starting Torque Limiter with dynamic brake, 3 phase	CCMB3H425

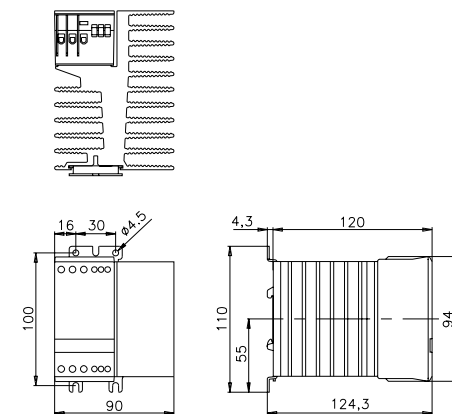


fig. 1. Wiring diagram



11-12: Thermostat
13-14: For control of Start/Stop function
23-24: By end of ramp up time for by-pass contactor

fig. 2. Dimensions (mm)



General data	
Module width	fig. 1
Weight	3 g
Protection degree	IP 66
Mounting	Slot on contactor
Application	fig. 2

Product references	
Description	Product reference
Thermal overload protection	P82-100C

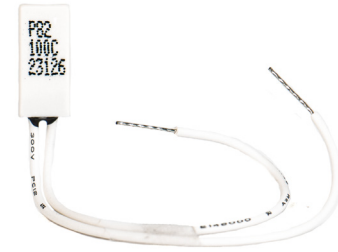
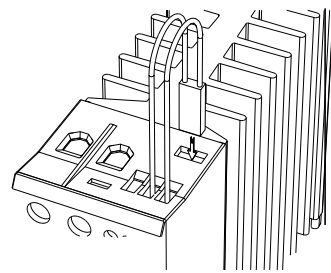
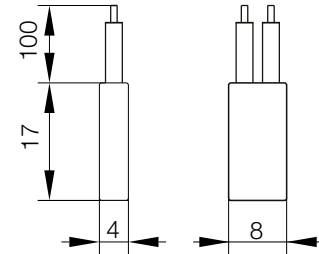
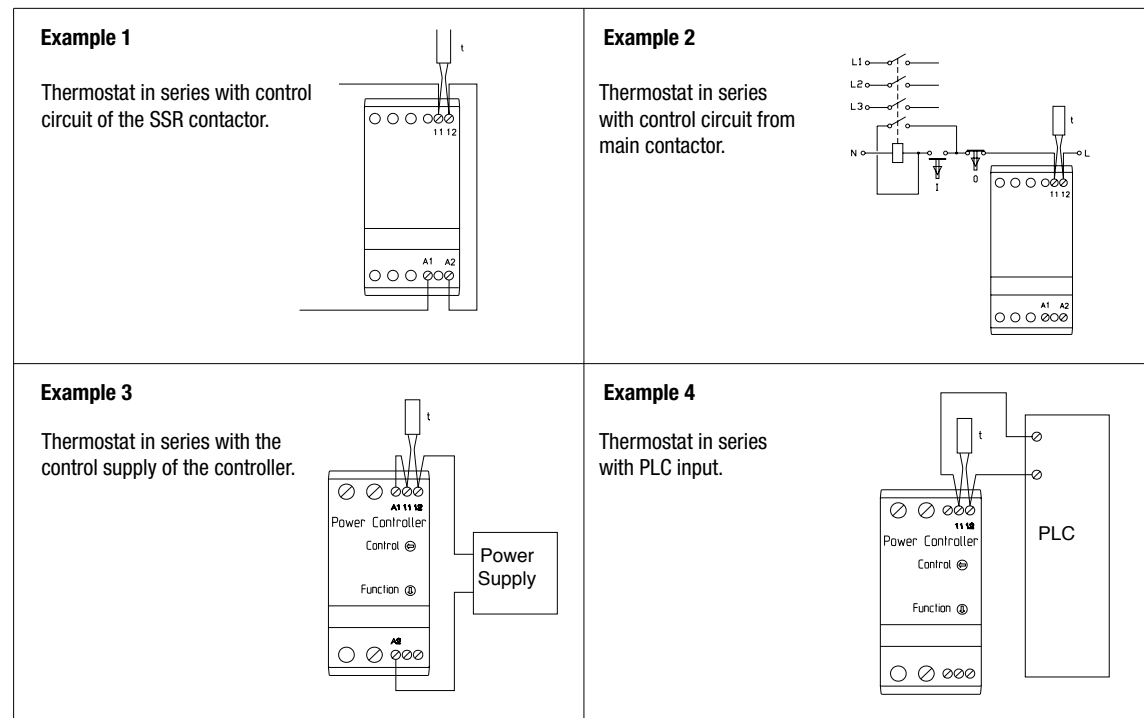


fig. 1. Dimensions (mm)



Optional thermal overload protection is possible by inserting a thermostat in a slot on the right hand side of the electronic contactor.

fig. 2. Wiring diagram



The thermostat is connected in series with the different control circuits. When the controller heatsink temperature exceeds 90° C, the device is switched off. When the controller heatsink has dropped to approx. 60° C, the control supply is switched On again (depending the chosen control circuit).

6.2 DC Motor Controller

Application	Type	Page
CMC Series		
DC Motor Controller digital inputs constant speed	CMC1	344
DC Motor Controller variable speed	CMC14	345
DC Motor Controller analogue inputs 0 ... 10 V variable speed	CMC15	346
DC Motor Controller analogue inputs 4 ... 20 mA variable speed	CMC16	347
KDM Series		
DC Motor Relay 1 output for motor 1 output for breaking resistor Faston	KDM3-24	348

CMC1

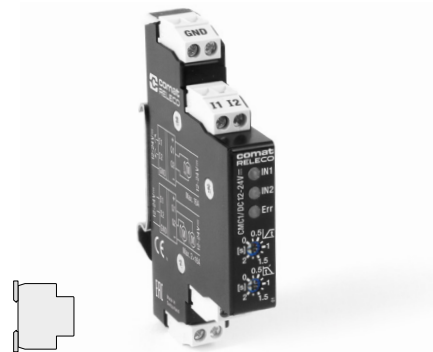
DC Motor Controller | digital inputs | constant speed

Maximum load	16 A / 24 V
Outputs	Drive
Type	Mosfet H bridge
Nominal switching current	16 A
Inrush current	20 A / max. 3 s
Nominal voltage	24 V
Switching power DC-5	384 W
Control Voltage V_n =	12-24 V
Nominal operating voltage range (DC)	12 – 24 V
Admissible voltage range (DC)	8 – 28 V
Current consumption	DC
12 V	3 mA
24 V	6 mA
Power supply	
Nominal operating voltage (DC)	12 – 24 V
Operating voltage (DC)	8 – 28 V
Max. current consumption without load	10 mA
Max. power consumption	DC
12 V	120 mW
24 V	240 mW
Time response	
Start ramp	0 – 4 s
Breaking ramp	0 – 4 s
Specifications	
Ambient temperature storage/operation	-40 ... 85°C / -25 ... +60°C (no ice)
Connection terminals	Screw terminal 2.5 mm ²
DC voltage endurance at rated load	> 100 000 h (at 25 °C)
Protection degree	IP 20
Mounting	TS-35 or Back Panel Mounting
Housing material	Aluminium
Weight	80 g

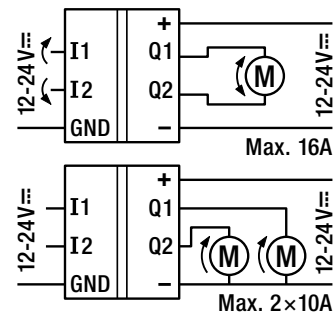
Product References

DC 12-24

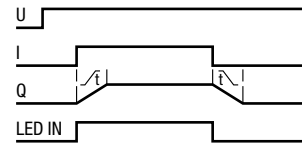
CMC1/DC12-24V



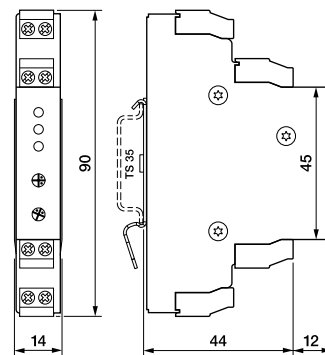
Connection diagram



Function diagram



Dimensions (mm)



Technical approvals, conformities



IEC/EN 61373

CMC14

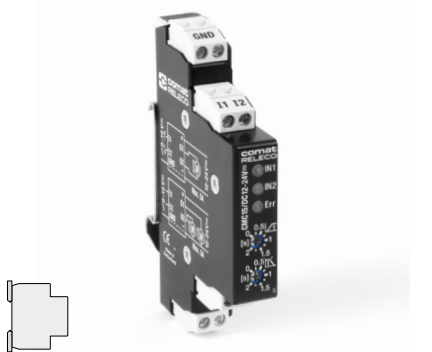
DC Motor Controller | variable speed

Maximum load	10 A / 24 V
Outputs	Drive
Type	Mosfet H bridge
Nominal switching current	10 A
Inrush current	20 A / max. 3 s
Nominal voltage	24 V
Switching power DC-5	240 W
Power supply	
Nominal operating voltage (DC)	12 – 24 V
Operating voltage (DC)	8 – 28 V
Max. current consumption without load	10 mA
Max. power consumption	DC
12 V	≤ 150 mW
24 V	≤ 300 mW
Time response	
Start ramp	0 – 4 s
Breaking ramp	0 – 4 s
Specifications	
Ambient temperature storage/operation	-40 ... 85°C / -25 ... +60°C (no ice)
Connection terminals	Screw terminal 2.5 mm ²
DC voltage endurance at rated load	> 100 000 h (at 25 °C)
Protection degree	IP 20
Mounting	TS-35 or Back Panel Mounting
Housing material	Aluminium
Weight	80 g

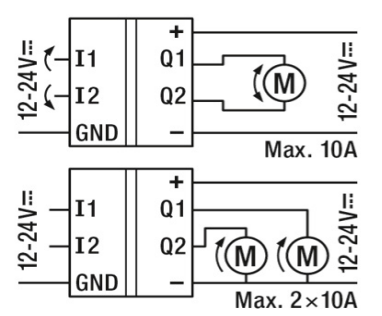
Product References

DC 12-24

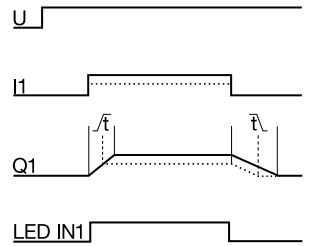
CMC14/DC12-24V



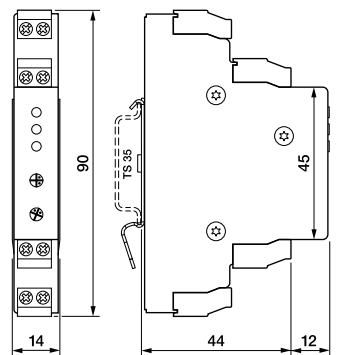
Connection diagram



Function diagram



Dimensions (mm)



Technical approvals, conformities



IEC/EN 61373

CMC15

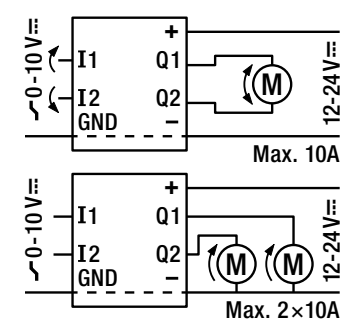
DC Motor Controller | analogue inputs 0 ... 10 V | variable speed

Maximum load	10 A / 24 V
Outputs	Drive
Type	Mosfet H bridge
Nominal switching current	10 A
Inrush current	20 A / max. 3 s
Nominal voltage	24 V
Switching power	240 W
Analogue inputs	
Nominal operating voltage range (DC)	0 – 10 V
Resolution	8 Bit
Input impedance	55 kΩ
Power supply	
Nominal operating voltage (DC)	12 – 24 V
Operating voltage (DC)	8 – 28 V
Max. current consumption without load	10 mA
Max. power consumption	DC
12 V	120 mW
24 V	240 mW
Time response	
Start ramp	0 – 2 s
Breaking ramp	0 – 2 s
Specifications	
Ambient temperature storage/operation	-40 ... 85°C / -25 ... +60°C (no ice)
Connection terminals	Screw terminal 2.5 mm ²
DC voltage endurance at rated load	> 100 000 h (at 25 °C)
Protection degree	IP 20
Mounting	TS-35 or Back Panel Mounting
Housing material	Aluminium
Weight	80 g

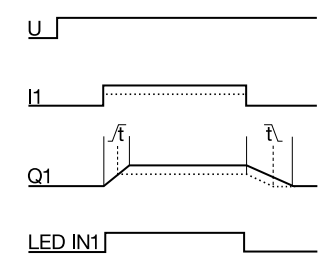
Product References
DC 12-24 CMC15/DC12-24V



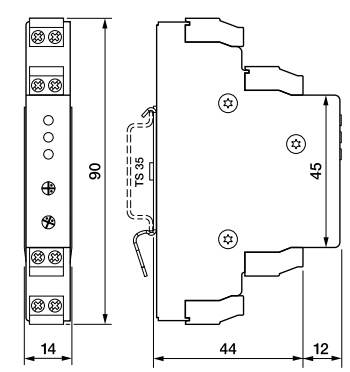
Connection diagram



Function diagram



Dimensions (mm)



Technical approvals, conformities



CMC16

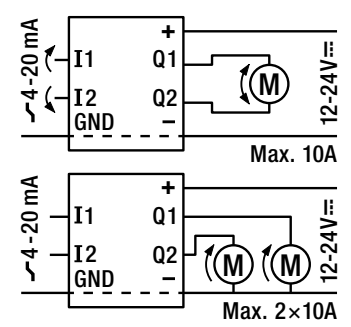
DC Motor Controller | analogue inputs 4 ... 20 mA | variable speed

Maximum load	10 A / 24 V
Outputs	Drive
Type	Mosfet H bridge
Nominal switching current	10 A
Inrush current	20 A / max. 3 s
Nominal voltage	24 V
Switching power	240 W
Analogue inputs	
Nominal operating voltage range (DC)	4 – 20 mA
Resolution	8 Bit
Input impedance	190 Ω
Power supply	
Nominal operating voltage (DC)	12 – 24 V
Operating voltage (DC)	8 – 28 V
Max. current consumption without load	10 mA
Max. power consumption	DC
12 V	120 mW
24 V	240 mW
Time response	
Start ramp	0 – 2 s
Breaking ramp	0 – 2 s
Specifications	
Ambient temperature storage/operation	-40 ... 85°C / -25 ... +60°C (no ice)
Connection terminals	Screw terminal 2.5 mm ²
DC voltage endurance at rated load	> 100 000 h (at 25 °C)
Protection degree	IP 20
Mounting	TS-35 or Back Panel Mounting
Housing material	Aluminium
Weight	80 g

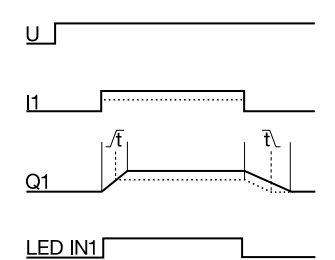
Product References
DC 12-24 CMC16/DC12-24V



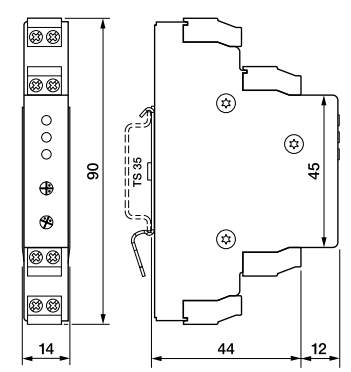
Connection diagram



Function diagram



Dimensions (mm)



Technical approvals, conformities



KDM3-24

DC Motor Relay | 1 output for motor | 1 output for braking resistor | Faston



Maximum load ⚡ **3 A / 32 V**

Outputs	Drive	Brake
Type: Power MOS FET	High side	N-channel
Max. switching current	3 A	3 A, 10 sec
Max. continuous current	3 A (5 A) ¹⁾	2 A
Max. inrush current, 1 sec ²⁾	20 A	7
Switching voltage range	10 ... 32 V	10 ... 32 V
Max. Load	100 W	65 W
Thermal overload protection ²⁾	self restoring	self restoring
Over current limiting ²⁾	type. 35 A	7 ... 14 A
Clamp voltage	type. 58 V	60 ... 70 V
Max. inductive switch-off energy ²⁾	1 Ws single pulse	0.4 Ws single pulse
ON resistance @ 25 °C	≤ 50 mΩ	≤ 100 mΩ
Leakage current	≤ 10 μA	

¹⁾ Repetitive operation: When the ratio t_{pulse} / t_{cycle} is a low value then the current can be increased up to 5 A @ $T_A \leq 50$ °C.

²⁾ Not for continuous repetitive operation

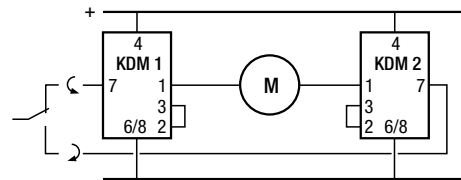
Control Voltage $V_N =$	DC 12-24 V
Operating voltage range	9 ... 28 V
Release voltage	≤ 2 V
Typical input current @ 12 / 24 V	2 / 6.5 mA
Power consumption @ 12 / 24 V	25 / 160 mW
Polarity reversal	protected

Specifications	
Ambient temperature storage/operation	-40 ... 85°C / -25 ... +60°C (no ice)
ON delay	1 ms
Release time	1 ms
Housing material	Lexan
Weight	27 g

Product References
DC 12-24 KDM3-24/DC12-24V R

Accessories
 Socket S7-C

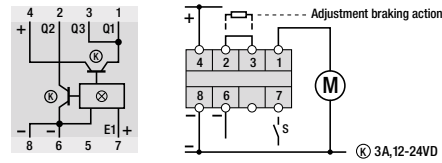
Application example
 Four quadrant (forward / reversed) motor control



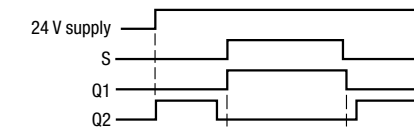
Operating with brake resistors (on 2-3) is not recommended in this application.



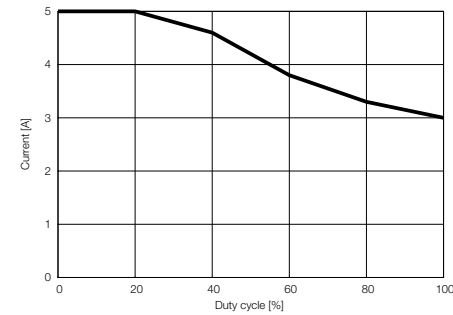
Connection diagram



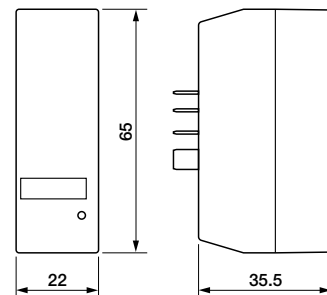
Function diagram



Output current vs. duty cycle



Dimensions (mm)



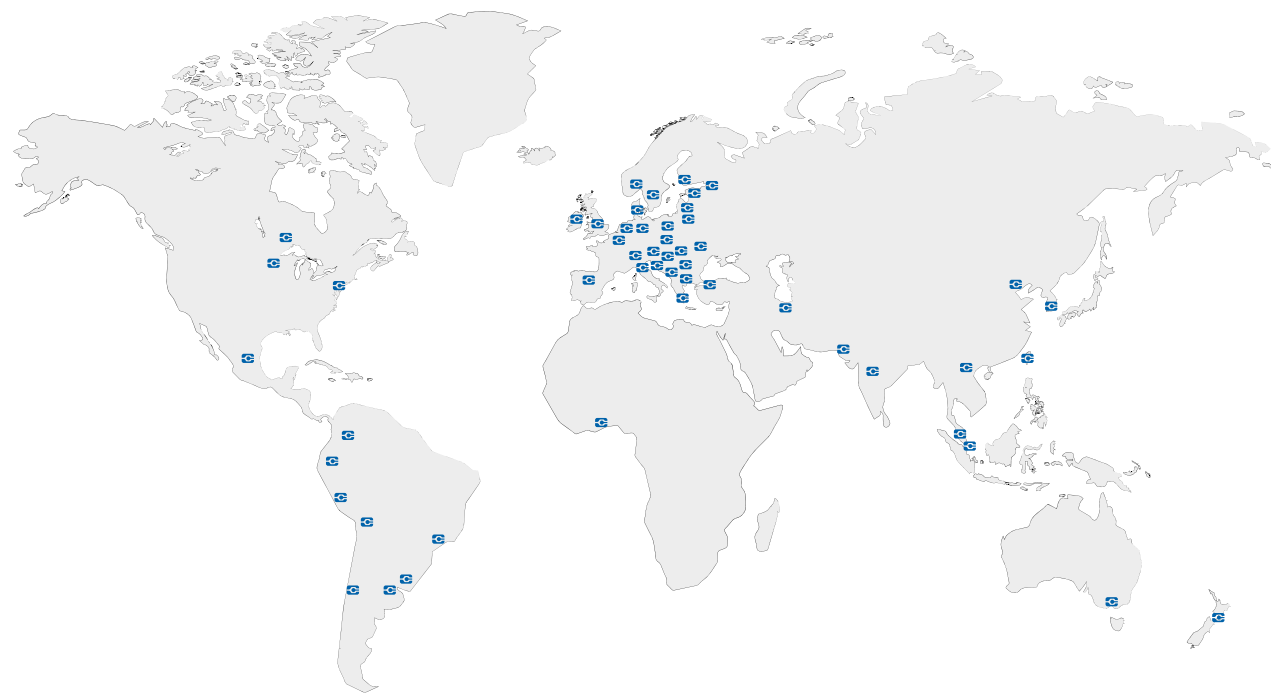
Technical approvals, conformities



Notes

--	--

WORLD OF RELAYS



ASIA

CHINA
ELCO (TIANJIN) ELECTRONICS CO., LTD.
www.elco-holding.com



PAKISTAN
GINZA INTERNATIONAL CORPORATION
Ginza-int@cyber.net.pk



TURKEY
ILERI OTOMASYON SISTEMLERI SAN. LTD. STI.
www.ileriotomasyon.com



INDIA
CONCORD AUTOMATION & CONTROLS
www.cacindia.net



SINGAPORE
FUTRON ELECTRONICS PTE. LTD.
www.futronelectronics.com.sg



VIETNAM
PLC PRODUCTION AND TRADE COMPANY LIMITED
plchanoi@gmail.com



IRAN
DANESH ENERGY SARIR CO.
www.desc-co.com



TAIWAN
Z-NANOCON & AUTOMATION INT'L CORP
www.e-sensors.com.tw



KOREA
MAHANI ELECTRIC CO., LTD.
www.mec.co.kr



THAILAND
538 CO., LTD.
538LTD@gmail.com



MALAYSIA
ELECTRICAL MARKETING SDN. BHD
emsb@tm.net.my



SRINUTCH COMPONENTS CO., LTD.
www.srinutch.com

AUSTRALIA

AUSTRALIA
ARLIN PTY LTD.
www.arlin.com.au



NEW ZEALAND
CUTHBERT STEWART LTD.
www.cuthbertstewart.co.nz



EUROPE

AUSTRIA
ELTAX ELEKTRO- UND KOMMUNIKATIONSTECHNIK GMBH
www.eltax.at



TURCK GmbH
www.turck.at

BELGIUM
TURCK MULTIPROX N.V.
www.multiprox.be



BOSNIA AND HERZEGOVINA
TIPTEH D.O.O.
www.tipteh.ba



BULGARIA
SENSOMAT LTD.
www.sensomat.info



CROATIA
TIPTEH ZAGREB D.O.O.
www.tipteh.hr



VARGA ELEKTRONIK D.O.O.
www.varga-elektronik.hr

CZECH REPUBLIC
OEM AUTOMATIC, SPOL. S.R.O.
www.oem-automatic.cz



TURCK S.R.O.
www.turck.cz

DENMARK
OEM AUTOMATIC KITSO A/S
www.oemklitso.dk



ESTONIA
OEM EESTI OÜ
www.oem.ee



FINLAND
OEM FINLAND OY
www.oem.fi



GERMANY
COMAT RELECO GMBH
www.comatreleco.de



GREAT BRITAIN
CAMIS ELECTRONICS LTD.
www.camiselectronicssuk.com



OEM AUPTOMATIC LTD.
www.oem.co.uk

GREECE
MEGA EL (VASSILIS GETSOS A.)
www.megael.gr



HUNGARY
OEM AUTOMATIC KFT.
www.oemautomatic.hu



IRELAND
TCM CONTROLS LTD.
www.tcmcontrols.com



ITALY
S.P.I.I. S.P.A.
www.spil.it



SOFTING ITALIA SRL.
www.softingitalia.it

LITHUANIA
HIDROTEKA ENGINEERING SERVICES
www.hidroteka.lt



LATVIA
OEM AUTOMATIC UAB
www.oem.ee



NETHERLANDS
VIERPOOL BV.
www.vierpool.nl



NORWAY
OEM AUTOMATIC AS
www.oem.no



POLAND
ANIM SPÓŁKA Z OGRANICZONA
ODPOWIEDZIALNOSCIA SP.K.
www.anim.com.pl



ASTAT LOGISTYKA SP. Z O.O.
www.astat.com.pl

OEM AUTOMATIC SP. Z O.O.
www.oemautomatic.com.pl

REPUBLIC OF MACEDONIA
TIPTEH SKOPJE D.O.O.
www.tipteh.mk



RUSSIA
POLIGON LTD.
www.poligon.info



SEVERCO, LTD.
elcomp@poligon.info

SERBIA
TIPTEH D.O.O. BEOGRAD
www.tipteh.rs



SLOVAKIA
MARPEX, S.R.O.
www.marpex.sk



OEM AUTOMATIC, S R.O.
www.oem.sk

SLOVENIA
TIPTEH D.O.O.
www.tipteh.si



SPAIN
DISAILECO, SL
www.disaileco.com



SWEDEN
BEVING ELEKTRONIK AB
www.beving.se



OEM AUTOMATIC AB
www.oemautomatic.se

SWITZERLAND
COMATRELECO AG
www.comatreleco.com



AFRICA

NIGERIA
PANEG GLOBAL SERVICES LTD.
www.paneglobal.com/



Notes

